

O'REILLY®

# Programming Rust

FAST, SAFE SYSTEMS DEVELOPMENT

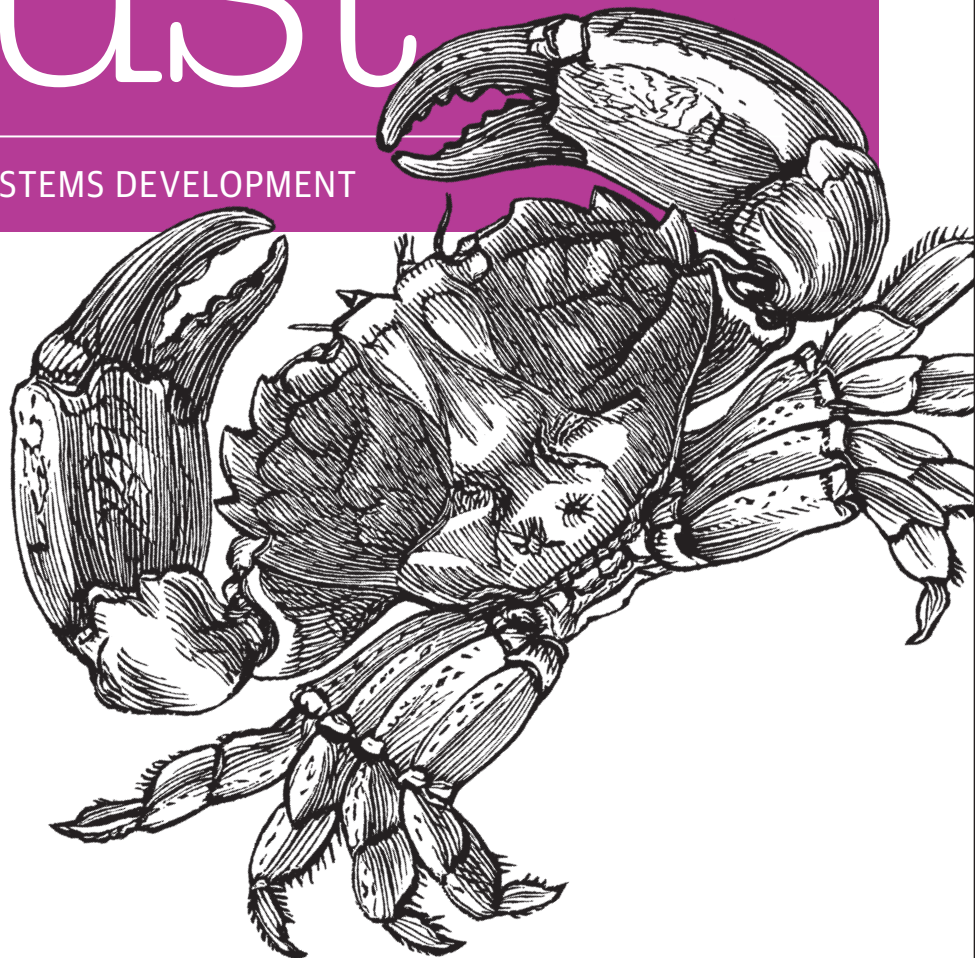

Jim Blandy & Jason Orendorff

# Programming Rust

Rust is a new systems programming language that combines the performance and low-level control of C and C++ with memory safety and thread safety. Rust's modern, flexible types ensure your program is free of null pointer dereferences, double frees, dangling pointers, and similar bugs, all at compile time, without runtime overhead. In multi-threaded code, Rust catches data races at compile time, making concurrency much easier to use.

Written by two experienced systems programmers, this book explains how Rust manages to bridge the gap between performance and safety, and how you can take advantage of it. Topics include:

- How Rust represents values in memory (with diagrams)
- Complete explanations of ownership, moves, borrows, and lifetimes
- Cargo, rustdoc, unit tests, and how to publish your code on crates.io, Rust's public package repository
- High-level features like generic code, closures, collections, and iterators that make Rust productive and flexible
- Concurrency in Rust: threads, mutexes, channels, and atomics, all much safer to use than in C or C++
- Unsafe code, and how to preserve the integrity of ordinary code that uses it
- Extended examples illustrating how pieces of the language fit together

*“Programming Rust is a welcome addition to any working Rust programmer’s bookshelf. It helps navigate the notoriously steep learning curve, especially ownership and lifetimes. I appreciate the fully worked examples and a deeper treatment of real-world problems.”*

—Raph Levien  
Google

**Jim Blandy** works on Firefox’s web developer tools for Mozilla. He’s been a maintainer of GNU Emacs and GNU Guile, as well as GDB, the GNU Debugger. Jim is one of the original designers of the Subversion version control system.

**Jason Orendorff** hacks C++ for Mozilla, where he is module owner of Firefox’s JavaScript engine. He is an active member of the Nashville developer community and an occasional organizer of homegrown tech events.

US \$59.99

CAN \$79.99

ISBN: 978-1-491-92728-1



5 5 9 9 9

9



Twitter: @oreillymedia  
facebook.com/oreilly

---

# Programming Rust

*Fast, Safe Systems Development*

*Jim Blandy and Jason Orendorff*

Beijing • Boston • Farnham • Sebastopol • Tokyo

**O'REILLY**<sup>®</sup>

## **Programming Rust**

by Jim Blandy and Jason Orendorff

Copyright © 2018 Jim Blandy, Jason Orendorff. All rights reserved.

Printed in the United States of America.

Published by O'Reilly Media, Inc., 1005 Gravenstein Highway North, Sebastopol, CA 95472.

O'Reilly books may be purchased for educational, business, or sales promotional use. Online editions are also available for most titles (<http://safaribooksonline.com>). For more information, contact our corporate/institutional sales department: 800-998-9938 or [corporate@oreilly.com](mailto:corporate@oreilly.com).

**Editors:** Jeff Bleiel

**Production Editor:** Colleen Cole

**Copyeditor:** Jasmine Kwityn

**Proofreader:** Sharon Wilkey

**Indexer:** WordCo Indexing Services, Inc.

**Interior Designer:** David Futato

**Cover Designer:** Karen Montgomery

**Illustrator:** Rebecca Demarest

December 2017: First Edition

### **Revision History for the First Edition**

2017-11-20: First Release

See <http://oreilly.com/catalog/errata.csp?isbn=9781491927212> for release details.

The O'Reilly logo is a registered trademark of O'Reilly Media, Inc. *Programming Rust*, the cover image, and related trade dress are trademarks of O'Reilly Media, Inc.

While the publisher and the authors have used good faith efforts to ensure that the information and instructions contained in this work are accurate, the publisher and the authors disclaim all responsibility for errors or omissions, including without limitation responsibility for damages resulting from the use of or reliance on this work. Use of the information and instructions contained in this work is at your own risk. If any code samples or other technology this work contains or describes is subject to open source licenses or the intellectual property rights of others, it is your responsibility to ensure that your use thereof complies with such licenses and/or rights.

978-1-491-92728-1

[M]



---

# Table of Contents

<b>Preface</b> .....	<b>xv</b>
<b>1. Why Rust?</b> .....	<b>1</b>
Type Safety	3
<b>2. A Tour of Rust</b> .....	<b>7</b>
Downloading and Installing Rust	7
A Simple Function	10
Writing and Running Unit Tests	11
Handling Command-Line Arguments	12
A Simple Web Server	17
Concurrency	23
What the Mandelbrot Set Actually Is	24
Parsing Pair Command-Line Arguments	28
Mapping from Pixels to Complex Numbers	31
Plotting the Set	32
Writing Image Files	33
A Concurrent Mandelbrot Program	35
Running the Mandelbrot Plotter	40
Safety Is Invisible	41
<b>3. Basic Types</b> .....	<b>43</b>
Machine Types	46
Integer Types	47
Floating-Point Types	50
The bool Type	51
Characters	52
Tuples	54

Pointer Types	55
References	56
Boxes	56
Raw Pointers	57
Arrays, Vectors, and Slices	57
Arrays	58
Vectors	59
Building Vectors Element by Element	62
Slices	62
String Types	64
String Literals	64
Byte Strings	65
Strings in Memory	65
String	67
Using Strings	68
Other String-Like Types	68
Beyond the Basics	69
<b>4. Ownership.....</b>	<b>71</b>
Ownership	73
Moves	77
More Operations That Move	82
Moves and Control Flow	84
Moves and Indexed Content	84
Copy Types: The Exception to Moves	86
Rc and Arc: Shared Ownership	90
<b>5. References.....</b>	<b>93</b>
References as Values	97
Rust References Versus C++ References	97
Assigning References	98
References to References	99
Comparing References	99
References Are Never Null	100
Borrowing References to Arbitrary Expressions	100
References to Slices and Trait Objects	101
Reference Safety	101
Borrowing a Local Variable	101
Receiving References as Parameters	105
Passing References as Arguments	107
Returning References	107
Structs Containing References	109

Distinct Lifetime Parameters	111
Omitting Lifetime Parameters	112
Sharing Versus Mutation	114
Taking Arms Against a Sea of Objects	121
<b>6. Expressions.....</b>	<b>123</b>
An Expression Language	123
Blocks and Semicolons	124
Declarations	126
if and match	127
if let	129
Loops	130
return Expressions	132
Why Rust Has loop	133
Function and Method Calls	134
Fields and Elements	135
Reference Operators	137
Arithmetic, Bitwise, Comparison, and Logical Operators	137
Assignment	138
Type Casts	139
Closures	140
Precedence and Associativity	140
Onward	142
<b>7. Error Handling.....</b>	<b>145</b>
Panic	145
Unwinding	146
Aborting	147
Result	148
Catching Errors	148
Result Type Aliases	150
Printing Errors	150
Propagating Errors	152
Working with Multiple Error Types	153
Dealing with Errors That “Can’t Happen”	155
Ignoring Errors	156
Handling Errors in main()	156
Declaring a Custom Error Type	157
Why Results?	158
<b>8. Crates and Modules.....</b>	<b>161</b>
Crates	161

Build Profiles	164
Modules	165
Modules in Separate Files	166
Paths and Imports	167
The Standard Prelude	169
Items, the Building Blocks of Rust	170
Turning a Program into a Library	172
The src/bin Directory	174
Attributes	175
Tests and Documentation	178
Integration Tests	180
Documentation	181
Doc-Tests	182
Specifying Dependencies	185
Versions	186
Cargo.lock	187
Publishing Crates to crates.io	188
Workspaces	190
More Nice Things	191
<b>9. Structs.....</b>	<b>193</b>
Named-Field Structs	193
Tuple-Like Structs	196
Unit-Like Structs	197
Struct Layout	197
Defining Methods with impl	198
Generic Structs	202
Structs with Lifetime Parameters	203
Deriving Common Traits for Struct Types	204
Interior Mutability	205
<b>10. Enums and Patterns.....</b>	<b>211</b>
Enums	212
Enums with Data	214
Enums in Memory	215
Rich Data Structures Using Enums	216
Generic Enums	218
Patterns	221
Literals, Variables, and Wildcards in Patterns	223
Tuple and Struct Patterns	225
Reference Patterns	226
Matching Multiple Possibilities	229

Pattern Guards	229
@ patterns	230
Where Patterns Are Allowed	230
Populating a Binary Tree	232
The Big Picture	233
<b>11. Traits and Generics.....</b>	<b>235</b>
Using Traits	237
Trait Objects	238
Trait Object Layout	239
Generic Functions	240
Which to Use	243
Defining and Implementing Traits	245
Default Methods	246
Traits and Other People's Types	247
Self in Traits	249
Subtraits	250
Static Methods	251
Fully Qualified Method Calls	252
Traits That Define Relationships Between Types	253
Associated Types (or How Iterators Work)	254
Generic Traits (or How Operator Overloading Works)	257
Buddy Traits (or How rand::random() Works)	258
Reverse-Engineering Bounds	260
Conclusion	263
<b>12. Operator Overloading.....</b>	<b>265</b>
Arithmetic and Bitwise Operators	266
Unary Operators	268
Binary Operators	269
Compound Assignment Operators	270
Equality Tests	272
Ordered Comparisons	275
Index and IndexMut	277
Other Operators	280
<b>13. Utility Traits.....</b>	<b>281</b>
Drop	282
Sized	285
Clone	287
Copy	289
Deref and DerefMut	289

Default	
AsRef and AsMut	294
Borrow and BorrowMut	296
From and Into	297
ToOwned	300
Borrow and ToOwned at Work: The Humble Cow	300
<b>14. Closures.....</b>	<b>303</b>
Capturing Variables	305
Closures That Borrow	306
Closures That Steal	306
Function and Closure Types	308
Closure Performance	310
Closures and Safety	311
Closures That Kill	312
FnOnce	312
FnMut	314
Callbacks	316
Using Closures Effectively	319
<b>15. Iterators.....</b>	<b>321</b>
The Iterator and IntoIterator Traits	322
Creating Iterators	324
iter and iter_mut Methods	324
IntoIterator Implementations	325
drain Methods	327
Other Iterator Sources	328
Iterator Adapters	330
map and filter	330
filter_map and flat_map	332
scan	335
take and take_while	335
skip and skip_while	336
peekable	337
fuse	338
Reversible Iterators and rev	339
inspect	340
chain	341
enumerate	341
zip	342
by_ref	342
cloned	344

cycle	344
Consuming Iterators	345
Simple Accumulation: count, sum, product	345
max, min	346
max_by, min_by	346
max_by_key, min_by_key	347
Comparing Item Sequences	347
any and all	348
position, rposition, and ExactSizeIterator	348
fold	349
nth	350
last	350
find	351
Building Collections: collect and FromIterator	351
The Extend Trait	353
partition	353
Implementing Your Own Iterators	354
<b>16. Collections.....</b>	<b>359</b>
Overview	360
Vec<T>	361
Accessing Elements	362
Iteration	364
Growing and Shrinking Vectors	364
Joining	367
Splitting	368
Swapping	370
Sorting and Searching	370
Comparing Slices	372
Random Elements	373
Rust Rules Out Invalidation Errors	373
VecDeque<T>	374
LinkedList<T>	376
BinaryHeap<T>	377
HashMap<K, V> and BTreeMap<K, V>	378
Entries	381
Map Iteration	383
HashSet<T> and BTreeSet<T>	384
Set Iteration	384
When Equal Values Are Different	385
Whole-Set Operations	385
Hashing	387



Using a Custom Hashing Algorithm	388
Beyond the Standard Collections	389
<b>17. Strings and Text.....</b>	<b>391</b>
Some Unicode Background	392
ASCII, Latin-1, and Unicode	392
UTF-8	392
Text Directionality	394
Characters (char)	394
Classifying Characters	395
Handling Digits	395
Case Conversion for Characters	396
Conversions to and from Integers	396
String and str	397
Creating String Values	398
Simple Inspection	398
Appending and Inserting Text	399
Removing Text	401
Conventions for Searching and Iterating	401
Patterns for Searching Text	402
Searching and Replacing	403
Iterating over Text	403
Trimming	406
Case Conversion for Strings	406
Parsing Other Types from Strings	406
Converting Other Types to Strings	407
Borrowing as Other Text-Like Types	408
Accessing Text as UTF-8	409
Producing Text from UTF-8 Data	409
Putting Off Allocation	410
Strings as Generic Collections	412
Formatting Values	413
Formatting Text Values	414
Formatting Numbers	415
Formatting Other Types	417
Formatting Values for Debugging	418
Formatting Pointers for Debugging	419
Referring to Arguments by Index or Name	419
Dynamic Widths and Precisions	420
Formatting Your Own Types	421
Using the Formatting Language in Your Own Code	423
Regular Expressions	424

Basic Regex Use	425
Building Regex Values Lazily	426
Normalization	427
Normalization Forms	428
The unicode-normalization Crate	429
<b>18. Input and Output.....</b>	<b>431</b>
Readers and Writers	432
Readers	433
Buffered Readers	435
Reading Lines	436
Collecting Lines	439
Writers	439
Files	441
Seeking	441
Other Reader and Writer Types	442
Binary Data, Compression, and Serialization	444
Files and Directories	445
OsStr and Path	445
Path and PathBuf Methods	447
Filesystem Access Functions	449
Reading Directories	450
Platform-Specific Features	451
Networking	453
<b>19. Concurrency.....</b>	<b>457</b>
Fork-Join Parallelism	459
spawn and join	461
Error Handling Across Threads	463
Sharing Immutable Data Across Threads	464
Rayon	466
Revisiting the Mandelbrot Set	468
Channels	470
Sending Values	472
Receiving Values	475
Running the Pipeline	476
Channel Features and Performance	478
Thread Safety: Send and Sync	479
Piping Almost Any Iterator to a Channel	482
Beyond Pipelines	483
Shared Mutable State	484
What Is a Mutex?	484

Mutex<T>	486
mut and Mutex	488
Why Mutexes Are Not Always a Good Idea	488
Deadlock	489
Poisoned Mutexes	490
Multi-producer Channels Using Mutexes	490
Read/Write Locks (RwLock<T>)	491
Condition Variables (Condvar)	493
Atomics	494
Global Variables	496
What Hacking Concurrent Code in Rust Is Like	497
<b>20. Macros.....</b>	<b>499</b>
Macro Basics	500
Basics of Macro Expansion	501
Unintended Consequences	503
Repetition	505
Built-In Macros	507
Debugging Macros	508
The json! Macro	509
Fragment Types	510
Recursion in Macros	513
Using Traits with Macros	514
Scoping and Hygiene	516
Importing and Exporting Macros	519
Avoiding Syntax Errors During Matching	521
Beyond macro_rules!	522
<b>21. Unsafe Code.....</b>	<b>525</b>
Unsafe from What?	526
Unsafe Blocks	527
Example: An Efficient ASCII String Type	529
Unsafe Functions	531
Unsafe Block or Unsafe Function?	533
Undefined Behavior	533
Unsafe Traits	536
Raw Pointers	538
Dereferencing Raw Pointers Safely	540
Example: RefWithFlag	541
Nullable Pointers	544
Type Sizes and Alignments	544
Pointer Arithmetic	545

Moving into and out of Memory	546
Example: GapBuffer	550
Panic Safety in Unsafe Code	556
Foreign Functions: Calling C and C++ from Rust	557
Finding Common Data Representations	558
Declaring Foreign Functions and Variables	561
Using Functions from Libraries	562
A Raw Interface to libgit2	566
A Safe Interface to libgit2	572
Conclusion	583
<b>Index.....</b>	<b>585</b>



---

# Preface

Rust is a language for systems programming.

This bears some explanation these days, as systems programming is unfamiliar to most working programmers. Yet it underlies everything we do.

You close your laptop. The operating system detects this, suspends all the running programs, turns off the screen, and puts the computer to sleep. Later, you open the laptop: the screen and other components are powered up again, and each program is able to pick up where it left off. We take this for granted. But systems programmers wrote a lot of code to make that happen.

Systems programming is for:

- Operating systems
- Device drivers of all kinds
- Filesystems
- Databases
- Code that runs in very cheap devices, or devices that must be extremely reliable
- Cryptography
- Media codecs (software for reading and writing audio, video, and image files)
- Media processing (for example, speech recognition or photo editing software)
- Memory management (for example, implementing a garbage collector)
- Text rendering (the conversion of text and fonts into pixels)
- Implementing higher-level programming languages (like JavaScript and Python)
- Networking
- Virtualization and software containers

- Scientific simulations
- Games

In short, systems programming is *resource-constrained* programming. It is programming when every byte and every CPU cycle counts.

The amount of systems code involved in supporting a basic app is staggering.

This book will not teach you systems programming. In fact, this book covers many details of memory management that might seem unnecessarily abstruse at first, if you haven't already done some systems programming on your own. But if you are a seasoned systems programmer, you'll find that Rust is something exceptional: a new tool that eliminates major, well-understood problems that have plagued a whole industry for decades.

## Who Should Read This Book

If you're already a systems programmer, and you're ready for an alternative to C++, this book is for you. If you're an experienced developer in any programming language, whether that's C#, Java, Python, JavaScript, or something else, this book is for you too.

However, you don't just need to learn Rust. To get the most out of the language, you also need to gain some experience with systems programming. We recommend reading this book while also implementing some systems programming side projects in Rust. Build something you've never built before, something that takes advantage of Rust's speed, concurrency, and safety. The list of topics at the beginning of this preface should give you some ideas.

## Why We Wrote This Book

We set out to write the book we wished we had when we started learning Rust. Our goal was to tackle the big, new concepts in Rust up front and head-on, presenting them clearly and in depth so as to minimize learning by trial and error.

## Navigating This Book

The first two chapters of this book introduce Rust and provide a brief tour before we move on to the fundamental data types in [Chapter 3](#). Chapters [4](#) and [5](#) address the core concepts of ownership and references. We recommend reading these first five chapters through in order.

Chapters [6](#) through [10](#) cover the basics of the language: expressions ([Chapter 6](#)), error handling ([Chapter 7](#)), crates and modules ([Chapter 8](#)), structs ([Chapter 9](#)), and



enums and patterns ([Chapter 10](#)). It's all right to skim a little here, but don't skip the chapter on error handling. Trust us.

[Chapter 11](#) covers traits and generics, the last two big concepts you need to know. Traits are like interfaces in Java or C#. They're also the main way Rust supports integrating your types into the language itself. [Chapter 12](#) shows how traits support operator overloading, and [Chapter 13](#) covers many more utility traits.

Understanding traits and generics unlocks the rest of the book. Closures and iterators, two key power tools that you won't want to miss, are covered in [Chapters 14](#) and [15](#), respectively. You can read the remaining chapters in any order, or just dip into them as needed. They cover the rest of the language: collections ([Chapter 16](#)), strings and text ([Chapter 17](#)), input and output ([Chapter 18](#)), concurrency ([Chapter 19](#)), macros ([Chapter 20](#)), and unsafe code ([Chapter 21](#)).

## Conventions Used in This Book

The following typographical conventions are used in this book:

### *Italic*

Indicates new terms, URLs, email addresses, filenames, and file extensions.

### Constant width

Used for program listings, as well as within paragraphs to refer to program elements such as variable or function names, databases, data types, environment variables, statements, and keywords.

### Constant width bold

Shows commands or other text that should be typed literally by the user.

### *Constant width italic*

Shows text that should be replaced with user-supplied values or by values determined by context.



This icon signifies a tip or suggestion.



This icon signifies a general note.



This icon indicates a warning or caution.

## Using Code Examples

Supplemental material (code examples, exercises, etc.) is available for download at [https://github.com/oreillymedia/programming\\_rust](https://github.com/oreillymedia/programming_rust).

This book is here to help you get your job done. In general, if example code is offered with this book, you may use it in your programs and documentation. You do not need to contact us for permission unless you're reproducing a significant portion of the code. For example, writing a program that uses several chunks of code from this book does not require permission. Selling or distributing a CD-ROM of examples from O'Reilly books does require permission. Answering a question by citing this book and quoting example code does not require permission. Incorporating a significant amount of example code from this book into your product's documentation does require permission.

We appreciate, but do not require, attribution. An attribution usually includes the title, author, publisher, and ISBN. For example: “*Programming Rust* by Jim Blandy and Jason Orendorff (O'Reilly). Copyright 2018 Jim Blandy and Jason Orendorff, 978-1-491-92728-1.”

If you feel your use of code examples falls outside fair use or the permission given above, feel free to contact us at [permissions@oreilly.com](mailto:permissions@oreilly.com).

## O'Reilly Safari

 **Safari**<sup>®</sup> Safari (formerly Safari Books Online) is a membership-based training and reference platform for enterprise, government, educators, and individuals.

Members have access to thousands of books, training videos, Learning Paths, interactive tutorials, and curated playlists from over 250 publishers, including O'Reilly Media, Harvard Business Review, Prentice Hall Professional, Addison-Wesley Professional, Microsoft Press, Sams, Que, Peachpit Press, Adobe, Focal Press, Cisco Press, John Wiley & Sons, Syngress, Morgan Kaufmann, IBM Redbooks, Packt, Adobe Press, FT Press, Apress, Manning, New Riders, McGraw-Hill, Jones & Bartlett, and Course Technology, among others.

For more information, please visit <http://oreilly.com/safari>.

# How to Contact Us

Please address comments and questions concerning this book to the publisher:

O'Reilly Media, Inc.  
1005 Gravenstein Highway North  
Sebastopol, CA 95472  
800-998-9938 (in the United States or Canada)  
707-829-0515 (international or local)  
707-829-0104 (fax)

We have a web page for this book, where we list errata, examples, and any additional information. You can access this page at <http://bit.ly/programming-rust>.

To comment or ask technical questions about this book, send email to [bookquestions@oreilly.com](mailto:bookquestions@oreilly.com).

For more information about our books, courses, conferences, and news, see our website at <http://www.oreilly.com>.

Find us on Facebook: <http://facebook.com/oreilly>

Follow us on Twitter: <http://twitter.com/oreillymedia>

Watch us on YouTube: <http://www.youtube.com/oreillymedia>

## Acknowledgments

The book you are holding has benefited greatly from the attention of our official technical reviewers: Brian Anderson, Matt Brubeck, J. David Eisenberg, and Jack Moffitt.

Many other unofficial reviewers read early drafts and provided invaluable feedback. We would like to thank Eddy Bruel, Nick Fitzgerald, Michael Kelly, Jeffrey Lim, Jakob Olesen, Gian-Carlo Pascutto, Larry Rabinowitz, Jaroslav Šnajdr, and Joe Walker for their thoughtful comments. Jeff Walden and Nicolas Pierron were especially generous with their time, reviewing almost the entire book. Like any programming venture, a programming book thrives on quality bug reports. Thank you.

Mozilla was extremely accommodating of our work on this project, even though it fell outside our official responsibilities and competed with them for our attention. We are grateful to our managers, Dave Camp, Naveed Ihsanullah, Tom Tromej, and Joe Walker, for their support. They take a long view of what Mozilla is about; we hope these results justify the faith they placed in us.

We would also like to express our appreciation for everyone at O'Reilly who helped bring this project to fruition, especially our editors Brian MacDonald and Jeff Bleiel.

Most of all, our heartfelt thanks to our wives and children for their unwavering love, enthusiasm, and patience.

# Why Rust?

---

*In certain contexts—for example the context Rust is targeting—being 10x or even 2x faster than the competition is a make-or-break thing. It decides the fate of a system in the market, as much as it would in the hardware market.*

—Graydon Hoare

*All computers are now parallel...  
Parallel programming **is** programming.*

—Michael McCool et al., *Structured Parallel Programming*

*TrueType parser flaw  
used by nation-state attacker for surveillance;  
all software is security-sensitive.*

—Andy Wingo

Systems programming languages have come a long way in the 50 years since we started using high-level languages to write operating systems, but two problems in particular have proven difficult to crack:

- It's difficult to write secure code. It's especially difficult to manage memory correctly in C and C++. Users have been suffering with the consequences for decades, in the form of security holes dating back at least as far as the 1988 Morris worm.
- It's very difficult to write multithreaded code, which is the only way to exploit the abilities of modern machines. Even experienced programmers approach threaded code with caution: concurrency can introduce broad new classes of bugs and make ordinary bugs much harder to reproduce.

Enter Rust: a safe, concurrent language with the performance of C and C++.

Rust is a new systems programming language developed by Mozilla and a community of contributors. Like C and C++, Rust gives developers fine control over the use of memory, and maintains a close relationship between the primitive operations of the language and those of the machines it runs on, helping developers anticipate their code's costs. Rust shares the ambitions Bjarne Stroustrup articulates for C++ in his paper "Abstraction and the C++ Machine Model:"

In general, C++ implementations obey the zero-overhead principle: What you don't use, you don't pay for. And further: What you do use, you couldn't hand code any better.

To these Rust adds its own goals of memory safety and trustworthy concurrency.

The key to meeting all these promises is Rust's novel system of *ownership*, *moves*, and *borrows*, checked at compile time and carefully designed to complement Rust's flexible static type system. The ownership system establishes a clear lifetime for each value, making garbage collection unnecessary in the core language, and enabling sound but flexible interfaces for managing other sorts of resources like sockets and file handles. Moves transfer values from one owner to another, and borrowing lets code use a value temporarily without affecting its ownership. Since many programmers will have never encountered these features in this form before, we explain them in detail in Chapters 4 and 5.

These same ownership rules also form the foundation of Rust's trustworthy concurrency model. Most languages leave the relationship between a mutex and the data it's meant to protect to the comments; Rust can actually check at compile time that your code locks the mutex while it accesses the data. Most languages admonish you to be sure not to use a data structure yourself after you've given it to another thread; Rust checks that you don't. Rust is able to prevent data races at compile time.

Rust is not really an object-oriented language, although it has some object-oriented characteristics. Rust is not a functional language, although it does tend to make the influences on a computation's result more explicit, as functional languages do. Rust resembles C and C++ to an extent, but many idioms from those languages don't apply, so typical Rust code does not deeply resemble C or C++ code. It's probably best to reserve judgement about what sort of language Rust is, and see what you think once you've become comfortable with the language.

To get feedback on the design in a real-world setting, Mozilla has developed Servo, a new web browser engine, in Rust. Servo's needs and Rust's goals are well matched: a browser must perform well and handle untrusted data securely. Servo uses Rust's safe concurrency to put the full machine to work on tasks that would be impractical to parallelize in C or C++. In fact, Servo and Rust have grown up together, with Servo using the latest new language features, and Rust evolving based on feedback from Servo's developers.

# Type Safety

Rust is a type-safe language. But what do we mean by “type safety”? Safety sounds good, but what exactly are we being kept safe from?

Here’s the definition of *undefined behavior* from the 1999 standard for the C programming language, known as C99:

## undefined behavior

behavior, upon use of a nonportable or erroneous program construct or of erroneous data, for which this International Standard imposes no requirements

Consider the following C program:

```
int main(int argc, char **argv) {
    unsigned long a[1];
    a[3] = 0x7ffff7b36cebUL;
    return 0;
}
```

According to C99, because this program accesses an element off the end of the array `a`, its behavior is undefined, meaning that it can do anything whatsoever. When we ran this program on Jim’s laptop, it produced the following output:

```
undef: Error: .netrc file is readable by others.
undef: Remove password or make file unreadable by others.
```

Then it crashed. Jim’s laptop doesn’t even have a `.netrc` file. If you try it yourself, it will probably do something entirely different.

The machine code the C compiler generated for this `main` function happens to place the array `a` on the stack three words before the return address, so storing `0x7ffff7b36cebUL` in `a[3]` changes poor `main`’s return address to point into the midst of code in the C standard library that consults one’s `.netrc` file for a password. When `main` returns, execution resumes not in `main`’s caller, but at the machine code for these lines from the library:

```
warnx(_("Error: .netrc file is readable by others."));
warnx(_("Remove password or make file unreadable by others."));
    goto bad;
```

In allowing an array reference to affect the behavior of a subsequent `return` statement, the C compiler is fully standards-compliant. An undefined operation doesn’t just produce an unspecified result: it is allowed to cause the program to do *anything at all*.

The C99 standard grants the compiler this *carte blanche* to allow it to generate faster code. Rather than making the compiler responsible for detecting and handling odd



behavior like running off the end of an array, the standard makes the programmer responsible for ensuring those conditions never arise in the first place.

Empirically speaking, we're not very good at that. While a student at the University of Utah, researcher Peng Li modified C and C++ compilers to make the programs they translated report when they executed certain forms of undefined behavior. He found that nearly all programs do, including those from well-respected projects that hold their code to high standards. And undefined behavior often leads to exploitable security holes in practice. The Morris worm propagated itself from one machine to another using an elaboration of the technique shown before, and this kind of exploit remains in widespread use today.

In light of that example, let's define some terms. If a program has been written so that no possible execution can exhibit undefined behavior, we say that program is *well defined*. If a language's safety checks ensure that every program is well defined, we say that language is *type safe*.

A carefully written C or C++ program might be well defined, but C and C++ are not type safe: the program shown earlier has no type errors, yet exhibits undefined behavior. By contrast, Python is type safe. Python is willing to spend processor time to detect and handle out-of-range array indices in a friendlier fashion than C:

```
>>> a = [0]
>>> a[3] = 0x7ffff7b36ceb
Traceback (most recent call last):
  File "<stdin>", line 1, in <module>
IndexError: list assignment index out of range
>>>
```

Python raised an exception, which is not undefined behavior: the Python documentation specifies that the assignment to `a[3]` should raise an `IndexError` exception, as we saw. Certainly, a module like `ctypes` that provides unconstrained access to the machine can introduce undefined behavior into Python, but the core language itself is type safe. Java, JavaScript, Ruby, and Haskell are similar in this way.

Note that being type safe is independent of whether a language checks types at compile time or at runtime: C checks at compile time, and is not type safe; Python checks at runtime, and is type safe.

It is ironic that the dominant systems programming languages, C and C++, are not type safe, while most other popular languages are. Given that C and C++ are meant to be used to implement the foundations of a system, entrusted with implementing security boundaries and placed in contact with untrusted data, type safety would seem like an especially valuable quality for them to have.

This is the decades-old tension Rust aims to resolve: it is both type safe and a systems programming language. Rust is designed for implementing those fundamental system layers that require performance and fine-grained control over resources, yet still

guarantees the basic level of predictability that type safety provides. We'll look at how Rust manages this unification in more detail in later parts of this book.

Rust's particular form of type safety has surprising consequences for multithreaded programming. Concurrency is notoriously difficult to use correctly in C and C++; developers usually turn to concurrency only when single-threaded code has proven unable to achieve the performance they need. But Rust guarantees that concurrent code is free of data races, catching any misuse of mutexes or other synchronization primitives at compile time. In Rust, you can use concurrency without worrying that you've made your code impossible for any but the most accomplished programmers to work on.

Rust has an escape valve from the safety rules, for when you absolutely have to use a raw pointer. This is called *unsafe code*, and while most Rust programs don't need it, we'll show how to use it and how it fits into Rust's overall safety scheme in [Chapter 21](#).

Like those of other statically typed languages, Rust's types can do much more than simply prevent undefined behavior. An accomplished Rust programmer uses types to ensure values are used not just safely but meaningfully, in a way that's consistent with the application's intent. In particular, Rust's traits and generics, described in [Chapter 11](#), provide a succinct, flexible, and performant way to describe characteristics that a group of types has in common, and then take advantage of those commonalities.

Our aim in this book is to give you the insights you need not just to write programs in Rust, but to put the language to work ensuring that those programs are both safe and correct, and to anticipate how they will perform. In our experience, Rust is a major step forward in systems programming, and we want to help you take advantage of it.



---

# A Tour of Rust

*Toute l'expérience d'un individu est construit sur le plan de son langage.  
(An individual's experience is built entirely in terms of his language.)*

—Henri Delacroix

In this chapter we'll look at several short programs to see how Rust's syntax, types, and semantics fit together to support safe, concurrent, and efficient code. We'll walk through the process of downloading and installing Rust, show some simple mathematical code, try out a web server based on a third-party library, and use multiple threads to speed up the process of plotting the Mandelbrot set.

## Downloading and Installing Rust

The best way to install Rust is to use `rustup`, the Rust installer. Go to <https://rustup.rs> and follow the instructions there.

You can, alternatively, go to <https://www.rust-lang.org>, click Downloads, and get pre-built packages for Linux, macOS, and Windows. Rust is also included in some operating system distributions. We prefer `rustup` because it's a tool for managing Rust installations, like `RVM` for Ruby or `NVM` for Node. For example, when a new version of Rust is released, you'll be able to upgrade with zero clicks by typing `rustup update`.

In any case, once you've completed the installation, you should have three new commands available at your command line:

```
$ cargo --version
cargo 0.18.0 (fe7b0cdcf 2017-04-24)
$ rustc --version
rustc 1.17.0 (56124baa9 2017-04-24)
$ rustdoc --version
```

```
rustdoc 1.17.0 (56124baa9 2017-04-24)
```

```
$
```

Here, the `$` is the command prompt; on Windows, this would be `C:\>` or something similar. In this transcript we run the three commands we installed, asking each to report which version it is. Taking each command in turn:

- `cargo` is Rust's compilation manager, package manager, and general-purpose tool. You can use Cargo to start a new project, build and run your program, and manage any external libraries your code depends on.
- `rustc` is the Rust compiler. Usually we let Cargo invoke the compiler for us, but sometimes it's useful to run it directly.
- `rustdoc` is the Rust documentation tool. If you write documentation in comments of the appropriate form in your program's source code, `rustdoc` can build nicely formatted HTML from them. Like `rustc`, we usually let Cargo run `rustdoc` for us.

As a convenience, Cargo can create a new Rust package for us, with some standard metadata arranged appropriately:

```
$ cargo new --bin hello
   Created binary (application) `hello` project
```

This command creates a new package directory named *hello*, and the `--bin` flag directs Cargo to prepare this as an executable, not a library. Looking inside the package's top-level directory:

```
$ cd hello
$ ls -la
total 24
drwxrwxr-x.  4 jimb jimb 4096 Sep 22 21:09 .
drwx----- 62 jimb jimb 4096 Sep 22 21:09 ..
drwxrwxr-x.  6 jimb jimb 4096 Sep 22 21:09 .git
-rw-rw-r--.  1 jimb jimb   7 Sep 22 21:09 .gitignore
-rw-rw-r--.  1 jimb jimb  88 Sep 22 21:09 Cargo.toml
drwxrwxr-x.  2 jimb jimb 4096 Sep 22 21:09 src
$
```

We can see that Cargo has created a file *Cargo.toml* to hold metadata for the package. At the moment this file doesn't contain much:

```
[package]
name = "hello"
version = "0.1.0"
authors = ["You <you@example.com>"]

[dependencies]
```

If our program ever acquires dependencies on other libraries, we can record them in this file, and Cargo will take care of downloading, building, and updating those libraries for us. We'll cover the *Cargo.toml* file in detail in [Chapter 8](#).

Cargo has set up our package for use with the *git* version control system, creating a *.git* metadata subdirectory, and a *.gitignore* file. You can tell Cargo to skip this step by specifying `--vcs none` on the command line.

The *src* subdirectory contains the actual Rust code:

```
$ cd src
$ ls -l
total 4
-rw-rw-r--. 1 jimb jimb 45 Sep 22 21:09 main.rs
```

It seems that Cargo has begun writing the program on our behalf. The *main.rs* file contains the text:

```
fn main() {
    println!("Hello, world!");
}
```

In Rust, you don't even need to write your own "Hello, World!" program. And this is the extent of the boilerplate for a new Rust program: two files, totaling nine lines.

We can invoke the `cargo run` command from any directory in the package to build and run our program:

```
$ cargo run
Compiling hello v0.1.0 (file:///home/jimb/rust/hello)
Finished dev [unoptimized + debuginfo] target(s) in 0.27 secs
Running `/home/jimb/rust/hello/target/debug/hello`
Hello, world!
$
```

Here, Cargo has invoked the Rust compiler, `rustc`, and then run the executable it produced. Cargo places the executable in the *target* subdirectory at the top of the package:

```
$ ls -l ../target/debug
total 580
drwxrwxr-x. 2 jimb jimb 4096 Sep 22 21:37 build
drwxrwxr-x. 2 jimb jimb 4096 Sep 22 21:37 deps
drwxrwxr-x. 2 jimb jimb 4096 Sep 22 21:37 examples
-rwxrwxr-x. 1 jimb jimb 576632 Sep 22 21:37 hello
-rw-rw-r--. 1 jimb jimb 198 Sep 22 21:37 hello.d
drwxrwxr-x. 2 jimb jimb 68 Sep 22 21:37 incremental
drwxrwxr-x. 2 jimb jimb 4096 Sep 22 21:37 native
$ ../target/debug/hello
Hello, world!
$
```

When we're through, Cargo can clean up the generated files for us:

```
$ cargo clean
$ ../target/debug/hello
bash: ../target/debug/hello: No such file or directory
$
```

## A Simple Function

Rust's syntax is deliberately unoriginal. If you are familiar with C, C++, Java, or JavaScript, you can probably find your way through the general structure of a Rust program. Here is a function that computes the greatest common divisor of two integers, using [Euclid's algorithm](#):

```
fn gcd(mut n: u64, mut m: u64) -> u64 {
    assert!(n != 0 && m != 0);
    while m != 0 {
        if m < n {
            let t = m;
            m = n;
            n = t;
        }
        m = m % n;
    }
    n
}
```

The `fn` keyword (pronounced “fun”) introduces a function. Here, we’re defining a function named `gcd`, which takes two parameters `n` and `m`, each of which is of type `u64`, an unsigned 64-bit integer. The `->` token precedes the return type: our function returns a `u64` value. Four-space indentation is standard Rust style.

Rust’s machine integer type names reflect their size and signedness: `i32` is a signed 32-bit integer; `u8` is an unsigned eight-bit integer (used for “byte” values), and so on. The `isize` and `usize` types hold pointer-sized signed and unsigned integers, 32 bits long on 32-bit platforms, and 64 bits long on 64-bit platforms. Rust also has two floating-point types, `f32` and `f64`, which are the IEEE single- and double-precision floating-point types, like `float` and `double` in C and C++.

By default, once a variable is initialized, its value can’t be changed, but placing the `mut` keyword (pronounced “mute”, short for *mutable*) before the parameters `n` and `m` allows our function body to assign to them. In practice, most variables don’t get assigned to; the `mut` keyword on those that do can be a helpful hint when reading code.

The function’s body starts with a call to the `assert!` macro, verifying that neither argument is zero. The `!` character marks this as a macro invocation, not a function call. Like the `assert` macro in C and C++, Rust’s `assert!` checks that its argument is



true, and if it is not, terminates the program with a helpful message including the source location of the failing check; this kind of abrupt termination is called a *panic*. Unlike C and C++, in which assertions can be skipped, Rust always checks assertions regardless of how the program was compiled. There is also a `debug_assert!` macro, whose assertions are skipped when the program is compiled for speed.

The heart of our function is a `while` loop containing an `if` statement and an assignment. Unlike C and C++, Rust does not require parentheses around the conditional expressions, but it does require curly braces around the statements they control.

A `let` statement declares a local variable, like `t` in our function. We don't need to write out `t`'s type, as long as Rust can infer it from how the variable is used. In our function, the only type that works for `t` is `u64`, matching `m` and `n`. Rust only infers types within function bodies: you must write out the types of function parameters and return values, as we did before. If we wanted to spell out `t`'s type, we could write:

```
let t: u64 = m;
```

Rust has a `return` statement, but the `gcd` function doesn't need one. If a function body ends with an expression that is *not* followed by a semicolon, that's the function's return value. In fact, any block surrounded by curly braces can function as an expression. For example, this is an expression that prints a message and then yields `x.cos()` as its value:

```
{
    println!("evaluating cos x");
    x.cos()
}
```

It's typical in Rust to use this form to establish the function's value when control "falls off the end" of the function, and use `return` statements only for explicit early returns from the midst of a function.

## Writing and Running Unit Tests

Rust has simple support for testing built into the language. To test our `gcd` function, we can write:

```
#[test]
fn test_gcd() {
    assert_eq!(gcd(14, 15), 1);

    assert_eq!(gcd(2 * 3 * 5 * 11 * 17,
                3 * 7 * 11 * 13 * 19),
                3 * 11);
}
```

Here we define a function named `test_gcd`, which calls `gcd` and checks that it returns correct values. The `#[test]` atop the definition marks `test_gcd` as a test function, to be skipped in normal compilations, but included and called automatically if we run our program with the `cargo test` command. Let's assume we've edited our `gcd` and `test_gcd` definitions into the *hello* package we created at the beginning of the chapter. If our current directory is somewhere within the package's subtree, we can run the tests as follows:

```
$ cargo test
  Compiling hello v0.1.0 (file:///home/jimb/rust/hello)
  Finished dev [unoptimized + debuginfo] target(s) in 0.35 secs
  Running /home/jimb/rust/hello/target/debug/deps/hello-2375a82d9e9673d7

running 1 test
test test_gcd ... ok

test result: ok. 1 passed; 0 failed; 0 ignored; 0 measured

$
```

We can have test functions scattered throughout our source tree, placed next to the code they exercise, and `cargo test` will automatically gather them up and run them all.

The `#[test]` marker is an example of an *attribute*. Attributes are an open-ended system for marking functions and other declarations with extra information, like attributes in C++ and C#, or annotations in Java. They're used to control compiler warnings and code style checks, include code conditionally (like `#ifdef` in C and C++), tell Rust how to interact with code written in other languages, and so on. We'll see more examples of attributes as we go.

## Handling Command-Line Arguments

If we want our program to take a series of numbers as command-line arguments and print their greatest common divisor, we can replace the `main` function with the following:

```
use std::io::Write;
use std::str::FromStr;

fn main() {
    let mut numbers = Vec::new();

    for arg in std::env::args().skip(1) {
        numbers.push(u64::from_str(&arg)
            .expect("error parsing argument"));
    }
}
```

```

if numbers.len() == 0 {
    writeln!(std::io::stderr(), "Usage: gcd NUMBER ...").unwrap();
    std::process::exit(1);
}

let mut d = numbers[0];
for m in &numbers[1..] {
    d = gcd(d, *m);
}

println!("The greatest common divisor of {:?} is {}",
        numbers, d);
}

```

This is a large block of code, so let's take it piece by piece:

```

use std::io::Write;
use std::str::FromStr;

```

The use declarations bring the two *traits* `Write` and `FromStr` into scope. We'll cover traits in detail in [Chapter 11](#), but for now we'll simply say that a trait is a collection of methods that types can implement. Although we never use the names `Write` or `FromStr` elsewhere in the program, a trait must be in scope in order to use its methods. In the present case:

- Any type that implements the `Write` trait has a `write_fmt` method that writes formatted text to a stream. The `std::io::Stderr` type implements `Write`, and we'll use the `writeln!` macro to print error messages; that macro expands to code that uses the `write_fmt` method.
- Any type that implements the `FromStr` trait has a `from_str` method that tries to parse a value of that type from a string. The `u64` type implements `FromStr`, and we'll call `u64::from_str` to parse our command-line arguments.

Moving on to the program's `main` function:

```

fn main() {

```

Our `main` function doesn't return a value, so we can simply omit the `->` and type that would normally follow the parameter list.

```

    let mut numbers = Vec::new();

```

We declare a mutable local variable `numbers`, and initialize it to an empty vector. `Vec` is Rust's growable vector type, analogous to C++'s `std::vector`, a Python list, or a JavaScript array. Even though vectors are designed to be grown and shrunk dynamically, we must still mark the variable `mut` for Rust to let us push numbers onto the end of it.

The type of `numbers` is `Vec<u64>`, a vector of `u64` values, but as before, we don't need to write that out. Rust will infer it for us, in part because what we push onto the vector are `u64` values, but also because we pass the vector's elements to `gcd`, which accepts only `u64` values.

```
for arg in std::env::args().skip(1) {
```

Here we use a `for` loop to process our command-line arguments, setting the variable `arg` to each argument in turn, and evaluating the loop body.

The `std::env::args` function returns an *iterator*, a value that produces each argument on demand, and indicates when we're done. Iterators are ubiquitous in Rust; the standard library includes other iterators that produce the elements of a vector, the lines of a file, messages received on a communications channel, and almost anything else that makes sense to loop over. Rust's iterators are very efficient: the compiler is usually able to translate them into the same code as a handwritten loop. We'll show how this works and give examples in [Chapter 15](#).

Beyond their use with `for` loops, iterators include a broad selection of methods you can use directly. For example, the first value produced by the iterator returned by `std::env::args` is always the name of the program being run. We want to skip that, so we call the iterator's `skip` method to produce a new iterator that omits that first value.

```
numbers.push(u64::from_str(&arg)
             .expect("error parsing argument"));
```

Here we call `u64::from_str` to attempt to parse our command-line argument `arg` as an unsigned 64-bit integer. Rather than a method we're invoking on some `u64` value we have at hand, `u64::from_str` is a function associated with the `u64` type, akin to a static method in C++ or Java. The `from_str` function doesn't return a `u64` directly, but rather a `Result` value that indicates whether the parse succeeded or failed. A `Result` value is one of two variants:

- A value written `Ok(v)`, indicating that the parse succeeded and `v` is the value produced
- A value written `Err(e)`, indicating that the parse failed and `e` is an error value explaining why

Functions that perform input or output or otherwise interact with the operating system all return `Result` types whose `Ok` variants carry successful results—the count of bytes transferred, the file opened, and so on—and whose `Err` variants carry an error code from the system. Unlike most modern languages, Rust does not have exceptions: all errors are handled using either `Result` or `panic`, as outlined in [Chapter 7](#).

We check the success of our parse by using `Result`'s `expect` method. If the result is some `Err(e)`, `expect` prints a message that includes a description of `e`, and exits the program immediately. However, if the result is `Ok(v)`, `expect` simply returns `v` itself, which we are finally able to push onto the end of our vector of numbers.

```
if numbers.len() == 0 {
    writeln!(std::io::stderr(), "Usage: gcd NUMBER ...").unwrap();
    std::process::exit(1);
}
```

There's no greatest common divisor of an empty set of numbers, so we check that our vector has at least one element, and exit the program with an error if it doesn't. We use the `writeln!` macro to write our error message to the standard error output stream, provided by `std::io::stderr()`. The `.unwrap()` call is a terse way to check that the attempt to print the error message did not itself fail; an `expect` call would work too, but that's probably not worth it.

```
let mut d = numbers[0];
for m in &numbers[1..] {
    d = gcd(d, *m);
}
```

This loop uses `d` as its running value, updating it to stay the greatest common divisor of all the numbers we've processed so far. As before, we must mark `d` as mutable, so that we can assign to it in the loop.

The `for` loop has two surprising bits to it. First, we wrote `for m in &numbers[1..]`; what is the `&` operator for? Second, we wrote `gcd(d, *m)`; what is the `*` in `*m` for? These two details are complementary to each other.

Up to this point, our code has operated only on simple values like integers that fit in fixed-size blocks of memory. But now we're about to iterate over a vector, which could be of any size whatsoever—possibly very large. Rust is cautious when handling such values: it wants to leave the programmer in control over memory consumption, making it clear how long each value lives, while still ensuring memory is freed promptly when no longer needed.

So when we iterate, we want to tell Rust that *ownership* of the vector should remain with `numbers`; we are merely *borrowing* its elements for the loop. The `&` operator in `&numbers[1..]` borrows a *reference* to the vector's elements from the second onward. The `for` loop iterates over the referenced elements, letting `m` borrow each element in succession. The `*` operator in `*m` *dereferences* `m`, yielding the value it refers to; this is the next `u64` we want to pass to `gcd`. Finally, since `numbers` owns the vector, Rust automatically frees it when `numbers` goes out of scope at the end of `main`.

Rust's rules for ownership and references are key to Rust's memory management and safe concurrency; we discuss them in detail in [Chapter 4](#) and its companion, [Chap-](#)

ter 5. You'll need to be comfortable with those rules to be comfortable in Rust, but for this introductory tour, all you need to know is that `&x` borrows a reference to `x`, and that `*r` is the value that the reference `r` refers to.

Continuing our walk through the program:

```
println!("The greatest common divisor of {:?} is {}",
        numbers, d);
```

Having iterated over the elements of `numbers`, the program prints the results to the standard output stream. The `println!` macro takes a template string, substitutes formatted versions of the remaining arguments for the `{...}` forms as they appear in the template string, and writes the result to the standard output stream.

Unlike C and C++, which require `main` to return zero if the program finished successfully, or a nonzero exit status if something went wrong, Rust assumes that if `main` returns at all, the program finished successfully. Only by explicitly calling functions like `expect` or `std::process::exit` can we cause the program to terminate with an error status code.

The `cargo run` command allows us to pass arguments to our program, so we can try out our command-line handling:

```
$ cargo run 42 56
  Compiling hello v0.1.0 (file:///home/jimb/rust/hello)
  Finished dev [unoptimized + debuginfo] target(s) in 0.38 secs
  Running `/home/jimb/rust/hello/target/debug/hello 42 56`
The greatest common divisor of [42, 56] is 14
$ cargo run 799459 28823 27347
  Finished dev [unoptimized + debuginfo] target(s) in 0.0 secs
  Running `/home/jimb/rust/hello/target/debug/hello 799459 28823 27347`
The greatest common divisor of [799459, 28823, 27347] is 41
$ cargo run 83
  Finished dev [unoptimized + debuginfo] target(s) in 0.0 secs
  Running `/home/jimb/rust/hello/target/debug/hello 83`
The greatest common divisor of [83] is 83
$ cargo run
  Finished dev [unoptimized + debuginfo] target(s) in 0.0 secs
  Running `/home/jimb/rust/hello/target/debug/hello`
Usage: gcd NUMBER ...
$
```

We've used a few features from Rust's standard library in this section. If you're curious about what else is available, we strongly encourage you to try out Rust's online documentation. It has a live search feature that makes exploration easy, and even includes links to the source code. The `rustup` command automatically installs a copy on your computer when you install Rust itself. You can view the standard library documentation in your browser with the command:

```
$ rustup doc --std
```

You can also view it on the web at <https://doc.rust-lang.org/>.

## A Simple Web Server

One of Rust's strengths is the freely available collection of library packages published on the website [crates.io](https://crates.io). The `cargo` command makes it easy for our own code to use a `crates.io` package: it will download the right version of the package, build it, and update it as requested. A Rust package, whether a library or an executable, is called a *crate*; Cargo and `crates.io` both derive their names from this term.

To show how this works, we'll put together a simple web server using the `iron` web framework, the `hyper` HTTP server, and various other crates on which they depend. As shown in [Figure 2-1](#), our website will prompt the user for two numbers, and compute their greatest common divisor.

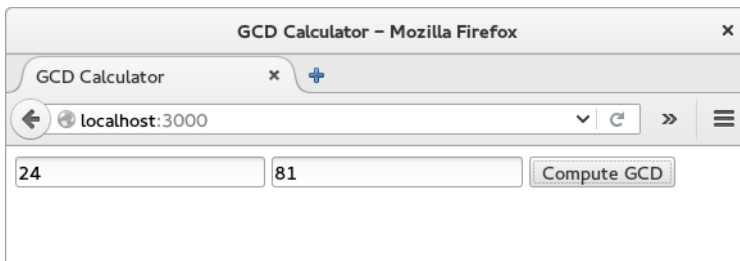

Figure 2-1. Web page offering to compute GCD

First, we'll have Cargo create a new package for us, named `iron-gcd`:

```
$ cargo new --bin iron-gcd
   Created binary (application) `iron-gcd` project
$ cd iron-gcd
$
```

Then, we'll edit our new project's `Cargo.toml` file to list the packages we want to use; its contents should be as follows:

```
[package]
name = "iron-gcd"
version = "0.1.0"
authors = ["You <you@example.com>"]

[dependencies]
iron = "0.5.1"
mime = "0.2.3"
router = "0.5.1"
urlencoded = "0.5.0"
```

Each line in the `[dependencies]` section of *Cargo.toml* gives the name of a crate on crates.io, and the version of that crate we would like to use. There may well be versions of these crates on crates.io newer than those shown here, but by naming the specific versions we tested this code against, we can ensure the code will continue to compile even as new versions of the packages are published. We'll discuss version management in more detail in [Chapter 8](#).

Note that we need only name those packages we'll use directly; cargo takes care of bringing in whatever other packages those need in turn.

For our first iteration, we'll keep the web server simple: it will serve only the page that prompts the user for numbers to compute with. In *iron-gcd/src/main.rs*, we'll place the following text:

```
extern crate iron;
#[macro_use] extern crate mime;

use iron::prelude::*;
use iron::status;

fn main() {
    println!("Serving on http://localhost:3000...");
    Iron::new(get_form).http("localhost:3000").unwrap();
}

fn get_form(_request: &mut Request) -> IronResult<Response> {
    let mut response = Response::new();

    response.set_mut(status::Ok);
    response.set_mut(mime!(Text/Html; Charset=UTF8));
    response.set_mut(r#"
        <title>GCD Calculator</title>
        <form action="/gcd" method="post">
            <input type="text" name="n"/>
            <input type="text" name="n"/>
            <button type="submit">Compute GCD</button>
        </form>
    "#);

    Ok(response)
}
```

We start with two `extern crate` directives, which make the `iron` and `mime` crates that we cited in our *Cargo.toml* file available to our program. The `#[macro_use]` attribute before the `extern crate mime` item alerts Rust that we plan to use macros exported by this crate.

Next, we have `use` declarations to bring in some of those crates' public features. The declaration `use iron::prelude::*` makes all the public names of the `iron::prelude` module directly visible in our own code. Generally, it's preferable to spell out the



name you wish to use, as we did for `iron::status`; but by convention, when a module is named `prelude`, that means that its exports are intended to provide the sort of general facilities that any user of the crate will probably need. So in this case, a wildcard use directive makes a bit more sense.

Our `main` function is simple: it prints a message reminding us how to connect to our server, calls `Iron::new` to create a server, and then sets it listening on TCP port 3000 on the local machine. We pass the `get_form` function to `Iron::new`, indicating that the server should use that function to handle all requests; we'll refine this shortly.

The `get_form` function itself takes a mutable reference, written `&mut`, to a `Request` value representing the HTTP request we've been called to handle. While this particular handler function never uses its `_request` parameter, we'll see one later that does. For the time being, giving the parameter a name beginning with `_` tells Rust that we expect the variable to be unused, so it shouldn't warn us about it.

In the body of the function, we build a `Response` value. The `set_mut` method uses its argument's type to decide which part of the response to set, so each call to `set_mut` is actually setting a different part of `response`: passing `status::Ok` sets the HTTP status; passing the media type of the content (using the handy `mime!` macro that we imported from the `mime` crate) sets the `Content-Type` header; and passing a string sets the response body.

Since the response text contains a lot of double quotes, we write it using the Rust “raw string” syntax: the letter `r`, zero or more hash marks (that is, the `#` character), a double quote, and then the contents of the string, terminated by another double quote followed by the same number of hash marks. Any character may occur within a raw string without being escaped, including double quotes; in fact, no escape sequences like `\` are recognized. We can always ensure the string ends where we intend by using more hash marks around the quotes than ever appear in the text.

Our function's return type, `IronResult<Response>`, is another variant of the `Result` type we encountered earlier: this is either `Ok(r)` for some successful `Response` value `r`, or `Err(e)` for some error value `e`. We construct our return value `Ok(response)` at the bottom of the function body, using the “last expression” syntax to implicitly specify the function's return value.

Having written `main.rs`, we can use the `cargo run` command to do everything needed to set it running: fetching the needed crates, compiling them, building our own program, linking everything together, and starting it up:

```
$ cargo run
  Updating registry `https://github.com/rust-lang/crates.io-index`
  Downloading iron v0.5.1
  Downloading urlencoded v0.5.0
  Downloading router v0.5.1
```

```

Downloading hyper v0.10.8
Downloading lazy_static v0.2.8
Downloading bodyparser v0.5.0
...
  Compiling conduit-mime-types v0.7.3
  Compiling iron v0.5.1
  Compiling router v0.5.1
  Compiling persistent v0.3.0
  Compiling bodyparser v0.5.0
  Compiling urlencoded v0.5.0
  Compiling iron-gcd v0.1.0 (file:///home/jimb/rust/iron-gcd)
    Running `target/debug/iron-gcd`
  Serving on http://localhost:3000...

```

At this point, we can visit the given URL in our browser and see the page shown earlier in [Figure 2-1](#).

Unfortunately, clicking Compute GCD doesn't do anything, other than navigate our browser to the URL `http://localhost:3000/gcd`, which then shows the same page; in fact, every URL on our server does this. Let's fix that next, using the Router type to associate different handlers with different paths.

First, let's arrange to be able to use Router without qualification, by adding the following declarations to `iron-gcd/src/main.rs`:

```

extern crate router;
use router::Router;

```

Rust programmers typically gather all their `extern crate` and `use` declarations together toward the top of the file, but this isn't strictly necessary: Rust allows declarations to occur in any order, as long as they appear at the appropriate level of nesting. (Macro definitions and `extern crate` items with `#[macro_use]` attributes are exceptions to this rule: they must appear before they are used.)

We can then modify our `main` function to read as follows:

```

fn main() {
    let mut router = Router::new();

    router.get("/", get_form, "root");
    router.post("/gcd", post_gcd, "gcd");

    println!("Serving on http://localhost:3000...");
    Iron::new(router).http("localhost:3000").unwrap();
}

```

We create a Router, establish handler functions for two specific paths, and then pass this Router as the request handler to `Iron::new`, yielding a web server that consults the URL path to decide which handler function to call.

Now we are ready to write our `post_gcd` function:

```

extern crate urlencoded;

use std::str::FromStr;
use urlencoded::UrlEncodedBody;

fn post_gcd(request: &mut Request) -> IronResult<Response> {
    let mut response = Response::new();

    let form_data = match request.get_ref:::<UrlEncodedBody>() {
        Err(e) => {
            response.set_mut(status::BadRequest);
            response.set_mut(format!("Error parsing form data: {:?}\n", e));
            return Ok(response);
        }
        Ok(map) => map
    };

    let unparsed_numbers = match form_data.get("n") {
        None => {
            response.set_mut(status::BadRequest);
            response.set_mut(format!("form data has no 'n' parameter\n"));
            return Ok(response);
        }
        Some(nums) => nums
    };

    let mut numbers = Vec::new();
    for unparsed in unparsed_numbers {
        match u64::from_str(&unparsed) {
            Err(_) => {
                response.set_mut(status::BadRequest);
                response.set_mut(
                    format!("Value for 'n' parameter not a number: {:?}\n",
                        unparsed));
                return Ok(response);
            }
            Ok(n) => { numbers.push(n); }
        }
    }

    let mut d = numbers[0];
    for m in &numbers[1..] {
        d = gcd(d, *m);
    }

    response.set_mut(status::Ok);
    response.set_mut(mime!(Text/Html; Charset=UTF8));
    response.set_mut(
        format!("The greatest common divisor of the numbers {:?} is <b>{}</b>\n",
            numbers, d));
    Ok(response)
}

```

The bulk of this function is a series of `match` expressions, which will be unfamiliar to C, C++, Java, and JavaScript programmers, but a welcome sight to those who work with Haskell and OCaml. We've mentioned that a `Result` is either a value `Ok(s)` for some success value `s`, or `Err(e)` for some error value `e`. Given some `Result res`, we can check which variant it is and access whichever value it holds with a `match` expression of the form:

```
match res {
  Ok(success) => { ... },
  Err(error)  => { ... }
}
```

This is a conditional, like an `if` statement or a `switch` statement in C: if `res` is `Ok(v)`, then it runs the first branch, with the variable `success` set to `v`. Similarly, if `res` is `Err(e)`, it runs the second branch with `error` set to `e`. The `success` and `error` variables are each local to their branch. The value of the entire `match` expression is the value of the branch that runs.

The beauty of a `match` expression is that the program can only access the value of a `Result` by first checking which variant it is; one can never misinterpret a failure value as a successful completion. Whereas in C and C++ it's a common error to forget to check for an error code or a null pointer, in Rust, these mistakes are caught at compile time. This simple measure is a significant advance in usability.

Rust allows you to define your own types like `Result` with value-carrying variants, and use `match` expressions to analyze them. Rust calls these types *enums*; you may know them from other languages as *algebraic data types*. We describe enumerations in detail in [Chapter 10](#).

Now that you can read `match` expressions, the structure of `post_gcd` should be clear:

- It calls `request.get_ref::<UrlEncodedBody>()` to parse the request's body as a table mapping query parameter names to arrays of values; if this parse fails, it reports the error back to the client. The `::<UrlEncodedBody>` part of the method call is a *type parameter* indicating which part of the `Request` `get_ref` should retrieve. In this case, the `UrlEncodedBody` type refers to the body, parsed as a URL-encoded query string. We'll talk more about type parameters in the next section.
- Within that table, it finds the value of the parameter named "n", which is where the HTML form places the numbers entered into the web page. This value will be not a single string but a vector of strings, as query parameter names can be repeated.
- It walks the vector of strings, parsing each one as an unsigned 64-bit number, and returning an appropriate failure page if any of the strings fail to parse.

- Finally, it computes the numbers' greatest common divisor as before, and constructs a response describing the results. The `format!` macro uses the same kind of string template as the `writeln!` and `println!` macros, but returns a string value, rather than writing the text to a stream.

The last remaining piece is the `gcd` function we wrote earlier. With that in place, you can interrupt any servers you might have left running, and rebuild and restart the program:

```
$ cargo run
  Compiling iron-gcd v0.1.0 (file:///home/jimb/rust/iron-gcd)
  Finished dev [unoptimized + debuginfo] target(s) in 0.0 secs
  Running `target/debug/iron-gcd`
  Serving on http://localhost:3000...
```

This time, by visiting `http://localhost:3000`, entering some numbers, and clicking the Compute GCD button, you should actually see some results (Figure 2-2).

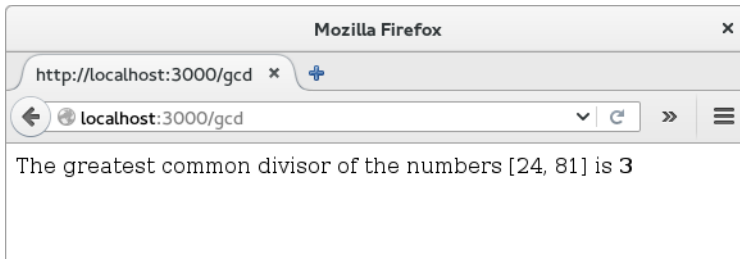

Figure 2-2. Web page showing results of computing GCD

## Concurrency

One of Rust's great strengths is its support for concurrent programming. The same rules that ensure Rust programs are free of memory errors also ensure threads can share memory only in ways that avoid data races. For example:

- If you use a mutex to coordinate threads making changes to a shared data structure, Rust ensures that you can't access the data except when you're holding the lock, and releases the lock automatically when you're done. In C and C++, the relationship between a mutex and the data it protects is left to the comments.
- If you want to share read-only data among several threads, Rust ensures that you cannot modify the data accidentally. In C and C++, the type system can help with this, but it's easy to get it wrong.
- If you transfer ownership of a data structure from one thread to another, Rust makes sure you have indeed relinquished all access to it. In C and C++, it's up to you to check that nothing on the sending thread will ever touch the data again. If

you don't get it right, the effects can depend on what happens to be in the processor's cache and how many writes to memory you've done recently. Not that we're bitter.

In this section, we'll walk you through the process of writing your second multi-threaded program.

Although you probably weren't aware of it, you've already written your first: the Iron web framework you used to implement the Greatest Common Divisor server uses a pool of threads to run request handler functions. If the server receives simultaneous requests, it may run the `get_form` and `post_gcd` functions in several threads at once. That may come as a bit of a shock, since we certainly didn't have concurrency in mind when we wrote those functions. But Rust guarantees this is safe to do, no matter how elaborate your server gets: if your program compiles, it is free of data races. All Rust functions are thread-safe.

This section's program plots the Mandelbrot set, a fractal produced by iterating a simple function on complex numbers. Plotting the Mandelbrot set is often called an *embarrassingly parallel* algorithm, because the pattern of communication between the threads is so simple; we'll cover more complex patterns in [Chapter 19](#), but this task demonstrates some of the essentials.

To get started, we'll create a fresh Rust project:

```
$ cargo new --bin mandelbrot
   Created binary (application) `mandelbrot` project
```

All the code will go in `mandelbrot/src/main.rs`, and we'll add some dependencies to `mandelbrot/Cargo.toml`.

Before we get into the concurrent Mandelbrot implementation, we need to describe the computation we're going to perform.

## What the Mandelbrot Set Actually Is

When reading code, it's helpful to have a concrete idea of what it's trying to do, so let's take a short excursion into some pure mathematics. We'll start with a simple case, and then add complicating details until we arrive at the calculation at the heart of the Mandelbrot set.

Here's an infinite loop, written using Rust's dedicated syntax for that, a `loop` statement:

```
fn square_loop(mut x: f64) {
    loop {
        x = x * x;
    }
}
```

In real life, Rust can see that `x` is never used for anything, and so might not bother computing its value. But for the time being, assume the code runs as written. What happens to the value of `x`? Squaring any number smaller than 1 makes it smaller, so it approaches zero; squaring 1 yields 1; squaring a number larger than 1 makes it larger, so it approaches infinity; and squaring a negative number makes it positive, after which it behaves as one of the prior cases (Figure 2-3).

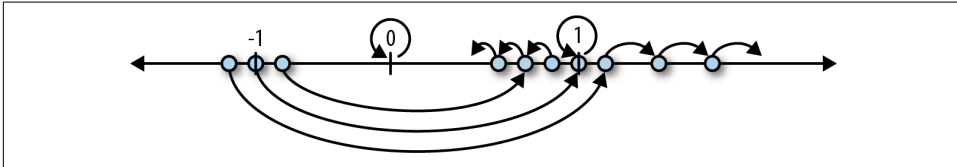

Figure 2-3. Effects of repeatedly squaring a number

So depending on the value you pass to `square_loop`, `x` either approaches zero, stays at 1, or approaches infinity.

Now consider a slightly different loop:

```
fn square_add_loop(c: f64) {  
    let mut x = 0.;  
    loop {  
        x = x * x + c;  
    }  
}
```

This time, `x` starts at zero, and we tweak its progress in each iteration by adding in `c` after squaring it. This makes it harder to see how `x` fares, but some experimentation shows that if `c` is greater than 0.25, or less than `-2.0`, then `x` eventually becomes infinitely large; otherwise, it stays somewhere in the neighborhood of zero.

The next wrinkle: instead of using `f64` values, consider the same loop using complex numbers. The `num` crate on [crates.io](https://crates.io) provides a complex number type we can use, so we must add a line for `num` to the `[dependencies]` section in our program's `Cargo.toml` file. Here's the entire file, up to this point (we'll be adding more later):

```
[package]  
name = "mandelbrot"  
version = "0.1.0"  
authors = ["You <you@example.com>"]  
  
[dependencies]  
num = "0.1.27"
```

Now we can write the penultimate version of our loop:

```
extern crate num;  
use num::Complex;
```

```
#[allow(dead_code)]
fn complex_square_add_loop(c: Complex<f64>) {
    let mut z = Complex { re: 0.0, im: 0.0 };
    loop {
        z = z * z + c;
    }
}
```

It's traditional to use `z` for complex numbers, so we've renamed our looping variable. The expression `Complex { re: 0.0, im: 0.0 }` is the way we write complex zero using the `num` crate's `Complex` type. `Complex` is a Rust structure type (or *struct*), defined like this:

```
struct Complex<T> {
    /// Real portion of the complex number
    re: T,

    /// Imaginary portion of the complex number
    im: T
}
```

The preceding code defines a struct named `Complex`, with two fields, `re` and `im`. `Complex` is a *generic* structure: you can read the `<T>` after the type name as “for any type `T`”. For example, `Complex<f64>` is a complex number whose `re` and `im` fields are `f64` values, `Complex<f32>` would use 32-bit floats, and so on. Given this definition, an expression like `Complex { re: R, im: I }` produces a `Complex` value with its `re` field initialized to `R`, and its `im` field initialized to `I`.

The `num` crate arranges for `*`, `+`, and other arithmetic operators to work on `Complex` values, so the rest of the function works just like the prior version, except that it operates on points on the complex plane, not just points along the real number line. We'll explain how you can make Rust's operators work with your own types in [Chapter 12](#).

Finally, we've reached the destination of our pure math excursion. The Mandelbrot set is defined as the set of complex numbers `c` for which `z` does not fly out to infinity. Our original simple squaring loop was predictable enough: any number greater than 1 or less than `-1` flies away. Throwing a `+ c` into each iteration makes the behavior a little harder to anticipate: as we said earlier, values of `c` greater than 0.25 or less than `-2` cause `z` to fly away. But expanding the game to complex numbers produces truly bizarre and beautiful patterns, which are what we want to plot.

Since a complex number `c` has both real and imaginary components `c.re` and `c.im`, we'll treat these as the `x` and `y` coordinates of a point on the Cartesian plane, and color the point black if `c` is in the Mandelbrot set, or a lighter color otherwise. So for each pixel in our image, we must run the preceding loop on the corresponding point on the complex plane, see whether it escapes to infinity or orbits around the origin forever, and color it accordingly.



The infinite loop takes a while to run, but there are two tricks for the impatient. First, if we give up on running the loop forever and just try some limited number of iterations, it turns out that we still get a decent approximation of the set. How many iterations we need depends on how precisely we want to plot the boundary. Second, it's been shown that, if  $z$  ever once leaves the circle of radius two centered at the origin, it will definitely fly infinitely far away from the origin eventually.

So here's the final version of our loop, and the heart of our program:

```
extern crate num;
use num::Complex;

/// Try to determine if `c` is in the Mandelbrot set, using at most `limit`
/// iterations to decide.
///
/// If `c` is not a member, return `Some(i)`, where `i` is the number of
/// iterations it took for `c` to leave the circle of radius two centered on the
/// origin. If `c` seems to be a member (more precisely, if we reached the
/// iteration limit without being able to prove that `c` is not a member),
/// return `None`.
fn escape_time(c: Complex<f64>, limit: u32) -> Option<u32> {
    let mut z = Complex { re: 0.0, im: 0.0 };
    for i in 0..limit {
        z = z*z + c;
        if z.norm_sqr() > 4.0 {
            return Some(i);
        }
    }

    None
}
```

This function takes the complex number  $c$  that we want to test for membership in the Mandelbrot set, and a limit on the number of iterations to try before giving up and declaring  $c$  to probably be a member.

The function's return value is an `Option<u32>`. Rust's standard library defines the `Option` type as follows:

```
enum Option<T> {
    None,
    Some(T),
}
```

`Option` is an *enumerated type*, often called an *enum*, because its definition enumerates several variants that a value of this type could be: for any type  $T$ , a value of type `Option<T>` is either `Some(v)`, where  $v$  is a value of type  $T$ ; or `None`, indicating no  $T$  value is available. Like the `Complex` type we discussed earlier, `Option` is a generic type: you can use `Option<T>` to represent an optional value of any type  $T$  you like.

In our case, `escape_time` returns an `Option<u32>` to indicate whether `c` is in the Mandelbrot set—and if it's not, how long we had to iterate to find that out. If `c` is not in the set, `escape_time` returns `Some(i)`, where `i` is the number of the iteration at which `z` left the circle of radius two. Otherwise, `c` is apparently in the set, and `escape_time` returns `None`.

```
for i in 0..limit {
```

The earlier examples showed for loops iterating over command-line arguments and vector elements; this for loop simply iterates over the range of integers starting with `0` and up to (but not including) `limit`.

The `z.norm_sqr()` method call returns the square of `z`'s distance from the origin. To decide whether `z` has left the circle of radius two, instead of computing a square root, we just compare the squared distance with `4.0`, which is faster.

You may have noticed that we use `///` to mark the comment lines above the function definition; the comments above the members of the `Complex` structure start with `///` as well. These are *documentation comments*; the `rustdoc` utility knows how to parse them, together with the code they describe, and produce online documentation. The documentation for Rust's standard library is written in this form. We describe documentation comments in detail in [Chapter 8](#).

The rest of the program is concerned with deciding which portion of the set to plot at what resolution, and distributing the work across several threads to speed up the calculation.

## Parsing Pair Command-Line Arguments

The program needs to take several command-line arguments controlling the resolution of the image we'll write, and the portion of the Mandelbrot set the image shows. Since these command-line arguments all follow a common form, here's a function to parse them:

```
use std::str::FromStr;

/// Parse the string `s` as a coordinate pair, like `"400x600"` or `"1.0,0.5"`.
///
/// Specifically, `s` should have the form <left><sep><right>, where <sep> is
/// the character given by the `separator` argument, and <left> and <right> are both
/// strings that can be parsed by `T::from_str`.
///
/// If `s` has the proper form, return `Some(x, y)`. If it doesn't parse
/// correctly, return `None`.
fn parse_pair<T: FromStr>(s: &str, separator: char) -> Option<(T, T)> {
    match s.find(separator) {
        None => None,
        Some(index) => {
```

```

        match (T::from_str(&s[..index]), T::from_str(&s[index + 1..])) {
            (Ok(l), Ok(r)) => Some((l, r)),
            _ => None
        }
    }
}

#[test]
fn test_parse_pair() {
    assert_eq!(parse_pair::<i32>(" ", ' '), None);
    assert_eq!(parse_pair::<i32>("10", ' '), None);
    assert_eq!(parse_pair::<i32>(" ", "10", ' '), None);
    assert_eq!(parse_pair::<i32>("10,20", ' '), Some((10, 20)));
    assert_eq!(parse_pair::<i32>("10,20xy", ' '), None);
    assert_eq!(parse_pair::<f64>("0.5x", 'x'), None);
    assert_eq!(parse_pair::<f64>("0.5x1.5", 'x'), Some((0.5, 1.5)));
}

```

The definition of `parse_pair` is a *generic function*:

```
fn parse_pair<T: FromStr>(s: &str, separator: char) -> Option<(T, T)> {
```

You can read the clause `<T: FromStr>` aloud as, “For any type `T` that implements the `FromStr` trait...” This effectively lets us define an entire family of functions at once: `parse_pair::<i32>` is a function that parses pairs of `i32` values; `parse_pair::<f64>` parses pairs of floating-point values; and so on. This is very much like a function template in C++. A Rust programmer would call `T` a *type parameter* of `parse_pair`. When you use a generic function, Rust will often be able to infer type parameters for you, and you won’t need to write them out as we did in the test code.

Our return type is `Option<(T, T)>`: either `None`, or a value `Some((v1, v2))`, where `(v1, v2)` is a tuple of two values, both of type `T`. The `parse_pair` function doesn’t use an explicit return statement, so its return value is the value of the last (and the only) expression in its body:

```

match s.find(separator) {
    None => None,
    Some(index) => {
        ...
    }
}

```

The `String` type’s `find` method searches the string for a character that matches `separator`. If `find` returns `None`, meaning that the separator character doesn’t occur in the string, the entire `match` expression evaluates to `None`, indicating that the parse failed. Otherwise, we take `index` to be the separator’s position in the string.

```

match (T::from_str(&s[..index]), T::from_str(&s[index + 1..])) {
    (Ok(l), Ok(r)) => Some((l, r)),
    _ => None
}

```

This begins to show off the power of the `match` expression. The argument to the match is this tuple expression:

```
(T::from_str(&s[..index]), T::from_str(&s[index + 1..]))
```

The expressions `&s[..index]` and `&s[index + 1..]` are slices of the string, preceding and following the separator. The type parameter `T`'s associated `from_str` function takes each of these and tries to parse them as a value of type `T`, producing a tuple of results. This is what we match against:

```
(Ok(l), Ok(r)) => Some((l, r)),
```

This pattern matches only if both elements of the tuple are `Ok` variants of the `Result` type, indicating that both parses succeeded. If so, `Some((l, r))` is the value of the match expression, and hence the return value of the function.

```
_ => None
```

The wildcard pattern `_` matches anything, and ignores its value. If we reach this point, then `parse_pair` has failed, so we evaluate to `None`, again providing the return value of the function.

Now that we have `parse_pair`, it's easy to write a function to parse a pair of floating-point coordinates and return them as a `Complex<f64>` value:

```

/// Parse a pair of floating-point numbers separated by a comma as a complex
/// number.
fn parse_complex(s: &str) -> Option<Complex<f64>> {
    match parse_pair(s, ',') {
        Some((re, im)) => Some(Complex { re, im }),
        None => None
    }
}

#[test]
fn test_parse_complex() {
    assert_eq!(parse_complex("1.25,-0.0625"),
        Some(Complex { re: 1.25, im: -0.0625 }));
    assert_eq!(parse_complex("-0.0625"), None);
}

```

The `parse_complex` function calls `parse_pair`, builds a `Complex` value if the coordinates were parsed successfully, and passes failures along to its caller.

If you were reading closely, you may have noticed that we used a shorthand notation to build the `Complex` value. It's common to initialize a struct's fields with variables of the same name, so rather than forcing you to write `Complex { re: re, im: im }`,

Rust lets you simply write `Complex { re, im }`. This is modeled on similar notations in JavaScript and Haskell.

## Mapping from Pixels to Complex Numbers

The program needs to work in two related coordinate spaces: each pixel in the output image corresponds to a point on the complex plane. The relationship between these two spaces depends on which portion of the Mandelbrot set we're going to plot, and the resolution of the image requested, as determined by command-line arguments. The following function converts from *image space* to *complex number space*:

```
/// Given the row and column of a pixel in the output image, return the
/// corresponding point on the complex plane.
///
/// `bounds` is a pair giving the width and height of the image in pixels.
/// `pixel` is a (column, row) pair indicating a particular pixel in that image.
/// The `upper_left` and `lower_right` parameters are points on the complex
/// plane designating the area our image covers.
fn pixel_to_point(bounds: (usize, usize),
                  pixel: (usize, usize),
                  upper_left: Complex<f64>,
                  lower_right: Complex<f64>)
    -> Complex<f64>
{
    let (width, height) = (lower_right.re - upper_left.re,
                           upper_left.im - lower_right.im);

    Complex {
        re: upper_left.re + pixel.0 as f64 * width / bounds.0 as f64,
        im: upper_left.im - pixel.1 as f64 * height / bounds.1 as f64
        // Why subtraction here? pixel.1 increases as we go down,
        // but the imaginary component increases as we go up.
    }
}

#[test]
fn test_pixel_to_point() {
    assert_eq!(pixel_to_point((100, 100), (25, 75),
                              Complex { re: -1.0, im: 1.0 },
                              Complex { re: 1.0, im: -1.0 })),
               Complex { re: -0.5, im: -0.5 });
}
```

Figure 2-4 illustrates the calculation `pixel_to_point` performs.

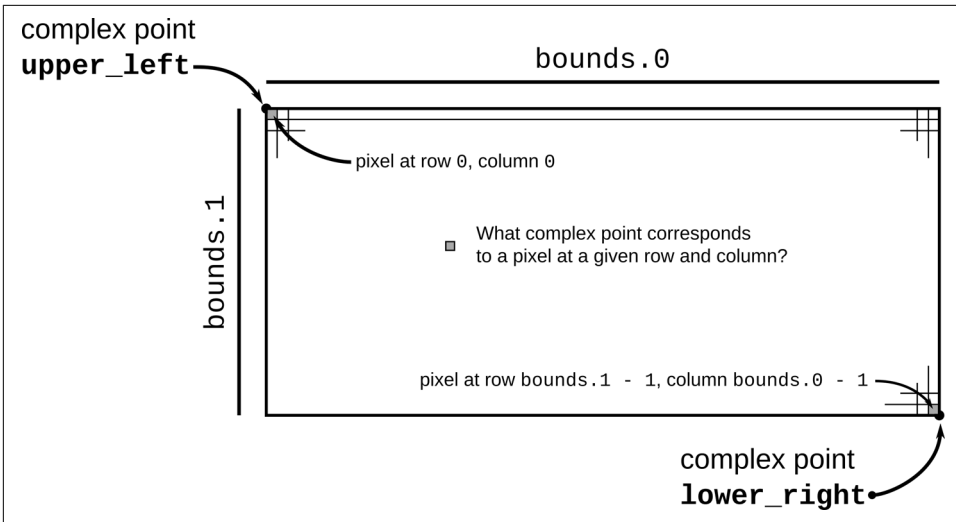

Figure 2-4. The relationship between the complex plane and the image's pixels

The code of `pixel_to_point` is simply calculation, so we won't explain it in detail. However, there are a few things to point out. Expressions with this form refer to tuple elements:

```
pixel.0
```

This refers to the first element of the tuple `pixel`.

```
pixel.0 as f64
```

This is Rust's syntax for a type conversion: this converts `pixel.0` to an `f64` value. Unlike C and C++, Rust generally refuses to convert between numeric types implicitly; you must write out the conversions you need. This can be tedious, but being explicit about which conversions occur and when is surprisingly helpful. Implicit integer conversions seem innocent enough, but historically they have been a frequent source of bugs and security holes in real-world C and C++ code.

## Plotting the Set

To plot the Mandelbrot set, for every pixel in the image, we simply apply `escape_time` to the corresponding point on the complex plane, and color the pixel depending on the result:

```
/// Render a rectangle of the Mandelbrot set into a buffer of pixels.
///
/// The `bounds` argument gives the width and height of the buffer `pixels`,
/// which holds one grayscale pixel per byte. The `upper_left` and `lower_right`
/// arguments specify points on the complex plane corresponding to the upper-
/// left and lower-right corners of the pixel buffer.
```

```

fn render(pixels: &mut [u8],
          bounds: (usize, usize),
          upper_left: Complex<f64>,
          lower_right: Complex<f64>)
{
    assert!(pixels.len() == bounds.0 * bounds.1);

    for row in 0 .. bounds.1 {
        for column in 0 .. bounds.0 {
            let point = pixel_to_point(bounds, (column, row),
                                       upper_left, lower_right);
            pixels[row * bounds.0 + column] =
                match escape_time(point, 255) {
                    None => 0,
                    Some(count) => 255 - count as u8
                };
        }
    }
}

```

This should all look pretty familiar at this point.

```

pixels[row * bounds.0 + column] =
    match escape_time(point, 255) {
        None => 0,
        Some(count) => 255 - count as u8
    };

```

If `escape_time` says that point belongs to the set, `render` colors the corresponding pixel black (0). Otherwise, `render` assigns darker colors to the numbers that took longer to escape the circle.

## Writing Image Files

The `image` crate provides functions for reading and writing a wide variety of image formats, along with some basic image manipulation functions. In particular, it includes an encoder for the PNG image file format, which this program uses to save the final results of the calculation. In order to use `image`, add the following line to the `[dependencies]` section of `Cargo.toml`:

```
image = "0.13.0"
```

With that in place, we can write:

```

extern crate image;

use image::ColorType;
use image::png::PNGEncoder;
use std::fs::File;

/// Write the buffer `pixels`, whose dimensions are given by `bounds`, to the
/// file named `filename`.

```

```

fn write_image(filename: &str, pixels: &[u8], bounds: (usize, usize))
    -> Result<(), std::io::Error>
{
    let output = File::create(filename)?;

    let encoder = PNGEncoder::new(output);
    encoder.encode(&pixels,
                  bounds.0 as u32, bounds.1 as u32,
                  ColorType::Gray(8))?;

    Ok(())
}

```

The operation of this function is pretty straightforward: it opens a file and tries to write the image to it. We pass the encoder the actual pixel data from `pixels`, and its width and height from `bounds`, and then a final argument that says how to interpret the bytes in `pixels`: the value `ColorType::Gray(8)` indicates that each byte is an eight-bit grayscale value.

That's all straightforward. What's interesting about this function is how it copes when something goes wrong. If we encounter an error, we need to report that back to our caller. As we've mentioned before, fallible functions in Rust should return a `Result` value, which is either `Ok(s)` on success, where `s` is the successful value, or `Err(e)` on failure, where `e` is an error code. So what are `write_image`'s success and error types?

When all goes well, our `write_image` function has no useful value to return; it wrote everything interesting to the file. So its success type is the *unit* type `()`, so called because it has only one value, also written `()`. The unit type is akin to `void` in C and C++.

When an error occurs, it's because either `File::create` wasn't able to create the file, or `encoder.encode` wasn't able to write the image to it; the I/O operation returned an error code. The return type of `File::create` is `Result<std::fs::File, std::io::Error>`, while that of `encoder.encode` is `Result<(), std::io::Error>`, so both share the same error type, `std::io::Error`. It makes sense for our `write_image` function to do the same.

Consider the call to `File::create`. If that returns `Ok(f)` for a successfully opened `File` value `f`, then `write_image` can proceed to write the image data to `f`. But if `File::create` returns `Err(e)` for an error code `e`, `write_image` should immediately return `Err(e)` as its own return value. The call to `encoder.encode` must be handled similarly: failure should result in an immediate return, passing along the error code.

The `?` operator exists to make these checks convenient. Instead of spelling everything out, and writing:

```

let output = match File::create(filename) {
    Ok(f) => { f }
}

```



```
    Err(e) => { return Err(e); }  
};
```

you can use the equivalent and much more legible:

```
let output = File::create(filename)?;
```



It's a common beginner's mistake to attempt to use `?` in the `main` function. However, since `main` has no return value, this won't work; you should use `Result`'s `expect` method instead. The `?` operator is only useful within functions that themselves return `Result`.

There's another shorthand we could use here. Because return types of the form `Result<T, std::io::Error>` for some type `T` are so common—this is often the right type for a function that does I/O—the Rust standard library defines a shorthand for it. In the `std::io` module, we have the definitions:

```
// The std::io::Error type.  
struct Error { ... };  
  
// The std::io::Result type, equivalent to the usual `Result`, but  
// specialized to use std::io::Error as the error type.  
type Result<T> = std::result::Result<T, Error>
```

If we bring this definition into scope with a `use std::io::Result` declaration, we can write `write_image`'s return type more tersely as `Result<>`. This is the form you will often see when reading the documentation for functions in `std::io`, `std::fs`, and elsewhere.

## A Concurrent Mandelbrot Program

Finally, all the pieces are in place, and we can show you the `main` function, where we can put concurrency to work for us. First, a nonconcurrent version for simplicity:

```
use std::io::Write;  
  
fn main() {  
    let args: Vec<String> = std::env::args().collect();  
  
    if args.len() != 5 {  
        writeln!(std::io::stderr(),  
            "Usage: mandelbrot FILE PIXELS UPPERLEFT LOWERRIGHT")  
            .unwrap();  
        writeln!(std::io::stderr(),  
            "Example: {} mandel.png 1000x750 -1.20,0.35 -1,0.20",  
            args[0])  
            .unwrap();  
        std::process::exit(1);  
    }  
}
```

```

let bounds = parse_pair(&args[2], 'x')
    .expect("error parsing image dimensions");
let upper_left = parse_complex(&args[3])
    .expect("error parsing upper left corner point");
let lower_right = parse_complex(&args[4])
    .expect("error parsing lower right corner point");

let mut pixels = vec![0; bounds.0 * bounds.1];

render(&mut pixels, bounds, upper_left, lower_right);

write_image(&args[1], &pixels, bounds)
    .expect("error writing PNG file");
}

```

After collecting the command-line arguments into a vector of Strings, we parse each one and then begin calculations.

```
let mut pixels = vec![0; bounds.0 * bounds.1];
```

A macro call `vec![v; n]` creates a vector `n` elements long whose elements are initialized to `v`, so the preceding code creates a vector of zeros whose length is `bounds.0 * bounds.1`, where `bounds` is the image resolution parsed from the command line. We'll use this vector as a rectangular array of one-byte grayscale pixel values, as shown in Figure 2-5.

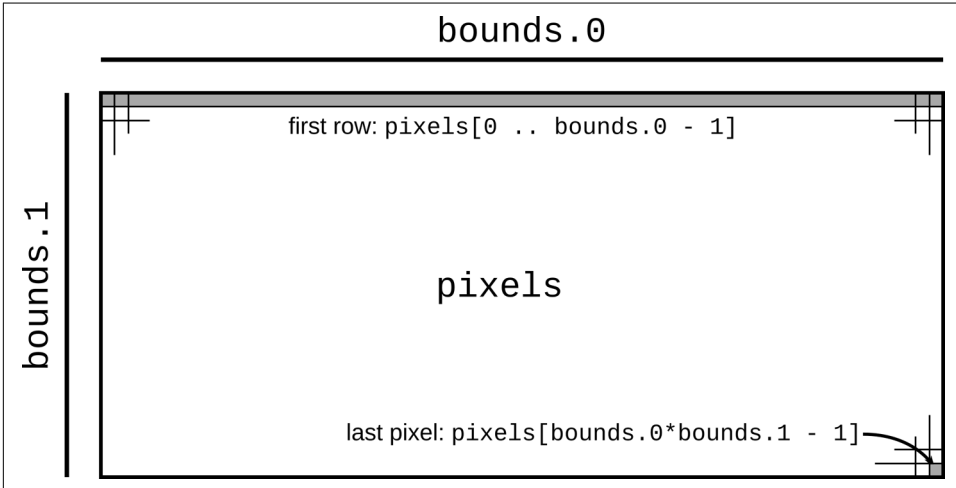

Figure 2-5. Using a vector as a rectangular array of pixels

The next line of interest is this:

```
render(&mut pixels, bounds, upper_left, lower_right);
```

This calls the `render` function to actually compute the image. The expression `&mut pixels` borrows a mutable reference to our pixel buffer, allowing `render` to fill it with computed grayscale values, even while `pixels` remains the vector's owner. The remaining arguments pass the image's dimensions, and the rectangle of the complex plane we've chosen to plot.

```
write_image(&args[1], &pixels, bounds)
    .expect("error writing PNG file");
```

Finally, we write the pixel buffer out to disk as a PNG file. In this case, we pass a shared (nonmutable) reference to the buffer, since `write_image` should have no need to modify the buffer's contents.

The natural way to distribute this calculation across multiple processors is to divide the image into sections, one per processor, and let each processor color the pixels assigned to it. For simplicity, we'll break it into horizontal bands, as shown in [Figure 2-6](#). When all processors have finished, we can write out the pixels to disk.

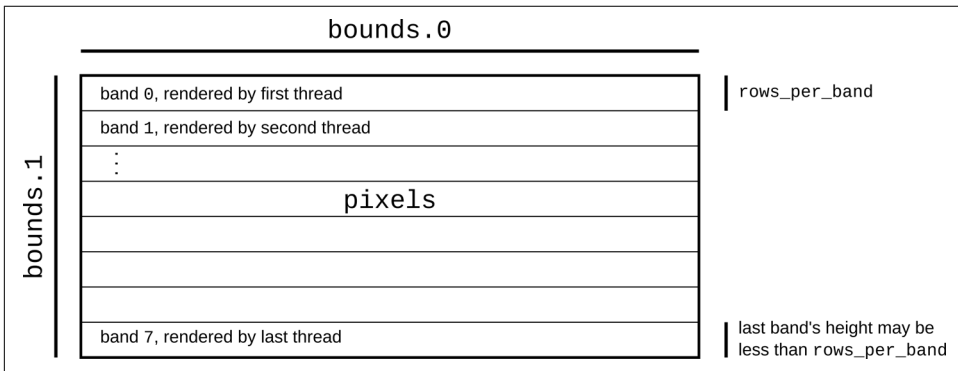

*Figure 2-6. Dividing the pixel buffer into bands for parallel rendering*

The `crossbeam` crate provides a number of valuable concurrency facilities, including a *scoped thread* facility that does exactly what we need here. To use it, we must add the following line to our `Cargo.toml` file:

```
crossbeam = "0.2.8"
```

Then, we must add the following line to the top of our `main.rs` file:

```
extern crate crossbeam;
```

Then we need to take out the single line calling `render`, and replace it with the following:

```
let threads = 8;
let rows_per_band = bounds.1 / threads + 1;

{
```

```

let bands: Vec<&mut [u8]> =
    pixels.chunks_mut(rows_per_band * bounds.0).collect();
crossbeam::scope(|spawner| {
    for (i, band) in bands.into_iter().enumerate() {
        let top = rows_per_band * i;
        let height = band.len() / bounds.0;
        let band_bounds = (bounds.0, height);
        let band_upper_left =
            pixel_to_point(bounds, (0, top), upper_left, lower_right);
        let band_lower_right =
            pixel_to_point(bounds, (bounds.0, top + height),
                upper_left, lower_right);

        spawner.spawn(move || {
            render(band, band_bounds, band_upper_left, band_lower_right);
        });
    }
});
}

```

Breaking this down in the usual way:

```

let threads = 8;
let rows_per_band = bounds.1 / threads + 1;

```

Here we decide to use eight threads.<sup>1</sup> Then we compute how many rows of pixels each band should have. Since the height of a band is `rows_per_band` and the overall width of the image is `bounds.0`, the area of a band, in pixels, is `rows_per_band * bounds.0`. We round the row count upward, to make sure the bands cover the entire image even if the height isn't a multiple of threads.

```

let bands: Vec<&mut [u8]> =
    pixels.chunks_mut(rows_per_band * bounds.0).collect();

```

Here we divide the pixel buffer into bands. The buffer's `chunks_mut` method returns an iterator producing mutable, nonoverlapping slices of the buffer, each of which encloses `rows_per_band * bounds.0` pixels—in other words, `rows_per_band` complete rows of pixels. The last slice that `chunks_mut` produces may contain fewer rows, but each row will contain the same number of pixels. Finally, the iterator's `collect` method builds a vector holding these mutable, nonoverlapping slices.

Now we can put the `crossbeam` library to work:

```

crossbeam::scope(|spawner| { ... });

```

The argument `|spawner| { ... }` is a Rust *closure* expression. A closure is a value that can be called as if it were a function. Here, `|spawner|` is the argument list, and

---

<sup>1</sup> The `num_cpus` crate provides a function that returns the number of CPUs available on the current system.

`{ ... }` is the body of the function. Note that, unlike functions declared with `fn`, we don't need to declare the types of a closure's arguments; Rust will infer them, along with its return type.

In this case, `crossbeam::scope` calls the closure, passing as the `spawner` argument a value the closure can use to create new threads. The `crossbeam::scope` function waits for all such threads to finish execution before returning itself. This behavior allows Rust to be sure that such threads will not access their portions of `pixels` after it has gone out of scope, and allows us to be sure that when `crossbeam::scope` returns, the computation of the image is complete.

```
for (i, band) in bands.into_iter().enumerate() {
```

Here we iterate over the pixel buffer's bands. The `into_iter()` iterator gives each iteration of the loop body exclusive ownership of one band, ensuring that only one thread can write to it at a time. We explain how this works in detail in [Chapter 5](#). Then, the `enumerate` adapter produces tuples pairing each vector element with its index.

```
let top = rows_per_band * i;
let height = band.len() / bounds.0;
let band_bounds = (bounds.0, height);
let band_upper_left =
    pixel_to_point(bounds, (0, top), upper_left, lower_right);
let band_lower_right =
    pixel_to_point(bounds, (bounds.0, top + height),
                   upper_left, lower_right);
```

Given the index and the actual size of the band (recall that the last one might be shorter than the others), we can produce a bounding box of the sort `render` requires, but one that refers only to this band of the buffer, not the entire image. Similarly, we repurpose the `renderer`'s `pixel_to_point` function to find where the band's upper-left and lower-right corners fall on the complex plane.

```
spawner.spawn(move || {
    render(band, band_bounds, band_upper_left, band_lower_right);
});
```

Finally, we create a thread, running the closure `move || { ... }`. This syntax is a bit strange to read: it denotes a closure of no arguments whose body is the `{ ... }` form. The `move` keyword at the front indicates that this closure takes ownership of the variables it uses; in particular, only the closure may use the mutable slice `band`.

As we mentioned earlier, the `crossbeam::scope` call ensures that all threads have completed before it returns, meaning that it is safe to save the image to a file, which is our next action.

## Running the Mandelbrot Plotter

We've used several external crates in this program: `num` for complex number arithmetic; `image` for writing PNG files; and `crossbeam` for the scoped thread creation primitives. Here's the final `Cargo.toml` file including all those dependencies:

```
[package]
name = "mandelbrot"
version = "0.1.0"
authors = ["You <you@example.com>"]

[dependencies]
crossbeam = "0.2.8"
image = "0.13.0"
num = "0.1.27"
```

With that in place, we can build and run the program:

```
$ cargo build --release
  Updating registry `https://github.com/rust-lang/crates.io-index`
  Compiling bitflags v0.3.3
  ...
  Compiling png v0.4.3
  Compiling image v0.13.0
  Compiling mandelbrot v0.1.0 (file:///home/jimb/rust/mandelbrot)
  Finished release [optimized] target(s) in 42.64 secs
$ time target/release/mandelbrot mandel.png 4000x3000 -1.20,0.35 -1,0.20
real    0m1.750s
user    0m6.205s
sys     0m0.026s
$
```

Here, we've used the Unix `time` program to see how long the program took to run; note that even though we spent more than six seconds of processor time computing the image, the elapsed real time was less than two seconds. You can verify that a substantial portion of that real time is spent writing the image file by commenting out the code that does so; on the laptop where this code was tested, the concurrent version reduces the Mandelbrot calculation time proper by a factor of almost four. We'll show how to substantially improve on this in [Chapter 19](#).

This command should create a file called `mandel.png`, which you can view with your system's image viewing program or in a web browser. If all has gone well, it should look like [Figure 2-7](#).

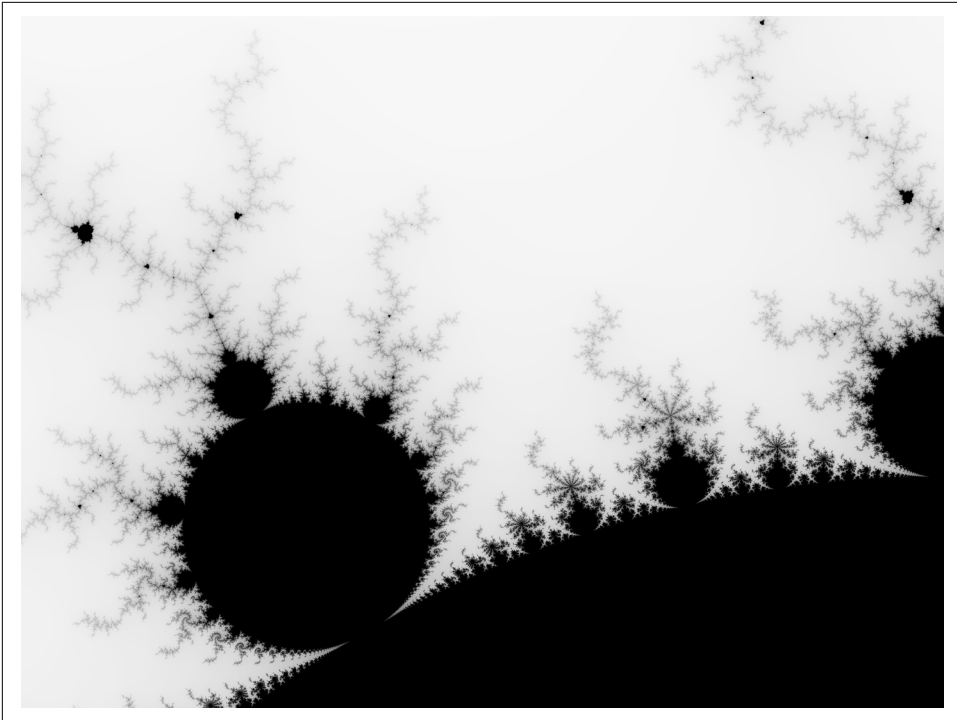

Figure 2-7. Results from parallel Mandelbrot program

## Safety Is Invisible

In the end, the parallel program we ended up with is not substantially different from what we might write in any other language: we apportion pieces of the pixel buffer out among the processors; let each one work on its piece separately; and when they've all finished, present the result. So what is so special about Rust's concurrency support?

What we haven't shown here is all the Rust programs we *cannot* write. The code we looked at in this chapter partitions the buffer among the threads correctly, but there are many small variations on that code that do not (and thus introduce data races); not one of those variations will pass the Rust compiler's static checks. A C or C++ compiler will cheerfully help you explore the vast space of programs with subtle data races; Rust tells you, up front, when something could go wrong.

In Chapters 4 and 5, we'll describe Rust's rules for memory safety. [Chapter 19](#) explains how these rules also ensure proper concurrency hygiene. But for those to make sense, it's essential to get a grounding in Rust's fundamental types, which we'll cover in the next chapter.





---

# Basic Types

*There are many, many types of books in the world, which makes good sense, because there are many, many types of people, and everybody wants to read something different.*

—Lemony Snicket

Rust's types serve several goals:

### *Safety*

By checking a program's types, the Rust compiler rules out whole classes of common mistakes. By replacing null pointers and unchecked unions with type-safe alternatives, Rust is even able to eliminate errors that are common sources of crashes in other languages.

### *Efficiency*

Programmers have fine-grained control over how Rust programs represent values in memory, and can choose types they know the processor will handle efficiently. Programs needn't pay for generality or flexibility they don't use.

### *Concision*

Rust manages all of this without requiring too much guidance from the programmer in the form of types written out in the code. Rust programs are usually less cluttered with types than the analogous C++ program would be.

Rather than using an interpreter or a just-in-time compiler, Rust is designed to use ahead-of-time compilation: the translation of your entire program to machine code is completed before it ever begins execution. Rust's types help an ahead-of-time compiler choose good machine-level representations for the values your program operates on: representations whose performance you can predict, and which give you full access to the machine's capabilities.

Rust is a *statically typed* language: without actually running the program, the compiler checks that every possible path of execution will use values only in ways consistent with their types. This allows Rust to catch many programming mistakes early, and is crucial to Rust's safety guarantees.

Compared to a dynamically typed language like JavaScript or Python, Rust requires more planning from you up front: you must spell out the types of functions' parameters and return values, members of struct types, and a few other constructs. However, two features of Rust make this less trouble than you might expect:

- Given the types that you did spell out, Rust will *infer* most of the rest for you. In practice, there's often only one type that will work for a given variable or expression; when this is the case, Rust lets you leave out the type. For example, you could spell out every type in a function, like this:

```
fn build_vector() -> Vec<i16> {  
    let mut v: Vec<i16> = Vec::<i16>::new();  
    v.push(10i16);  
    v.push(20i16);  
    v  
}
```

But this is cluttered and repetitive. Given the function's return type, it's obvious that `v` must be a `Vec<i16>`, a vector of 16-bit signed integers; no other type would work. And from that it follows that each element of the vector must be an `i16`. This is exactly the sort of reasoning Rust's type inference applies, allowing you to instead write:

```
fn build_vector() -> Vec<i16> {  
    let mut v = Vec::new();  
    v.push(10);  
    v.push(20);  
    v  
}
```

These two definitions are exactly equivalent; Rust will generate the same machine code either way. Type inference gives back much of the legibility of dynamically typed languages, while still catching type errors at compile time.

- Functions can be *generic*: when a function's purpose and implementation are general enough, you can define it to work on any set of types that meet the necessary criteria. A single definition can cover an open-ended set of use cases.

In Python and JavaScript, all functions work this way naturally: a function can operate on any value that has the properties and methods the function will need. (This is the characteristic often called *duck typing*: if it quacks like a duck, it's a duck.) But it's exactly this flexibility that makes it so difficult for those languages to detect type errors early; testing is often the only way to catch such mistakes.

Rust's generic functions give the language a degree of the same flexibility, while still catching all type errors at compile time.

Despite their flexibility, generic functions are just as efficient as their nongeneric counterparts. We'll discuss generic functions in detail in [Chapter 11](#).

The rest of this chapter covers Rust's types from the bottom up, starting with simple machine types like integers and floating-point values, and then showing how to compose them into more complex structures. Where appropriate, we'll describe how Rust represents values of these types in memory, and their performance characteristics.

Here's a summary of the sorts of types you'll see in Rust. This table shows Rust's primitive types, some very common types from the standard library, and some examples of user-defined types:

Type	Description	Values
<code>i8, i16, i32, i64, u8, u16, u32, u64</code>	Signed and unsigned integers, of given bit width	42, <code>-5i8</code> , <code>0x400u16</code> , <code>0o100i16</code> , <code>20_922_789_888_000u64</code> , <code>b'***'</code> (u8 byte literal)
<code>isize, usize</code>	Signed and unsigned integers, the same size as an address on the machine (32 or 64 bits)	137, <code>-0b0101_0010isize</code> , <code>0xffff_fc00usize</code>
<code>f32, f64</code>	IEEE floating-point numbers, single and double precision	1.61803, 3.14f32, 6.0221e23f64
<code>bool</code>	Boolean	<code>true</code> , <code>false</code>
<code>char</code>	Unicode character, 32 bits wide	<code>'*'</code> , <code>'\n'</code> , <code>'字'</code> , <code>'\x7f'</code> , <code>'\u{CA0}'</code>
<code>(char, u8, i32)</code>	Tuple: mixed types allowed	<code>('%', 0x7f, -1)</code>
<code>()</code>	"unit" (empty) tuple	<code>()</code>
<code>struct S { x: f32, y: f32 }</code>	Named-field struct	<code>S { x: 120.0, y: 209.0 }</code>
<code>struct T(i32, char);</code>	Tuple-like struct	<code>T(120, 'X')</code>
<code>struct E;</code>	Unit-like struct; has no fields	<code>E</code>
<code>enum Attend { OnTime, Late(u32) }</code>	Enumeration, algebraic data type	<code>Attend::Late(5)</code> , <code>Attend::OnTime</code>
<code>Box&lt;Attend&gt;</code>	Box: owning pointer to value in heap	<code>Box::new(Late(15))</code>

Type	Description	Values
<code>&amp;i32, &amp;mut i32</code>	Shared and mutable references: nonowning pointers that must not outlive their referent	<code>&amp;s.y, &amp;mut v</code>
<code>String</code>	UTF-8 string, dynamically sized	<code>"ラーメン: ramen".to_string()</code>
<code>&amp;str</code>	Reference to <code>str</code> : nonowning pointer to UTF-8 text	<code>"そば: soba", &amp;s[0..12]</code>
<code>[f64; 4], [u8; 256]</code>	Array, fixed length; elements all of same type	<code>[1.0, 0.0, 0.0, 1.0], [b' '; 256]</code>
<code>Vec&lt;f64&gt;</code>	Vector, varying length; elements all of same type	<code>vec![0.367, 2.718, 7.389]</code>
<code>&amp;[u8], &amp;mut [u8]</code>	Reference to slice: reference to a portion of an array or vector, comprising pointer and length	<code>&amp;v[10..20], &amp;mut a[..]</code>
<code>&amp;Any, &amp;mut Read</code>	Trait object: reference to any value that implements a given set of methods	value as <code>&amp;Any</code> , <code>&amp;mut file</code> as <code>&amp;mut Read</code>
<code>fn(&amp;str, usize) -&gt; isize</code>	Pointer to function	<code>i32::saturating_add</code>
(Closure types have no written form)	Closure	<code> a, b  a*a + b*b</code>

Most of these types are covered in this chapter, except for the following:

- We give struct types their own chapter, [Chapter 9](#).
- We give enumerated types their own chapter, [Chapter 10](#).
- We describe trait objects in [Chapter 11](#).
- We describe the essentials of `String` and `&str` here, but provide more detail in [Chapter 17](#).
- We cover function and closure types in [Chapter 14](#).

## Machine Types

The footing of Rust's type system is a collection of fixed-width numeric types, chosen to match the types that almost all modern processors implement directly in hardware, and the Boolean and character types.

The names of Rust's numeric types follow a regular pattern, spelling out their width in bits, and the representation they use:

Size (bits)	Unsigned integer	Signed integer	Floating-point
8	u8	i8	
16	u16	i16	
32	u32	i32	f32
64	u64	i64	f64
Machine word	usize	isize	

Here, a *machine word* is a value the size of an address on the machine the code runs on, usually 32 or 64 bits.

## Integer Types

Rust’s unsigned integer types use their full range to represent positive values and zero:

Type	Range
u8	0 to $2^8-1$ (0 to 255)
u16	0 to $2^{16}-1$ (0 to 65,535)
u32	0 to $2^{32}-1$ (0 to 4,294,967,295)
u64	0 to $2^{64}-1$ (0 to 18,446,744,073,709,551,615, or 18 quintillion)
usize	0 to either $2^{32}-1$ or $2^{64}-1$

Rust’s signed integer types use the two’s complement representation, using the same bit patterns as the corresponding unsigned type to cover a range of positive and negative values:

Type	Range
i8	$-2^7$ to $2^7-1$ (–128 to 127)
i16	$-2^{15}$ to $2^{15}-1$ (–32,768 to 32,767)
i32	$-2^{31}$ to $2^{31}-1$ (–2,147,483,648 to 2,147,483,647)
i64	$-2^{63}$ to $2^{63}-1$ (–9,223,372,036,854,775,808 to 9,223,372,036,854,775,807)
isize	Either $-2^{31}$ to $2^{31}-1$ , or $-2^{63}$ to $2^{63}-1$

Rust generally uses the u8 type for byte values. For example, reading data from a file or socket yields a stream of u8 values.

Unlike C and C++, Rust treats characters as distinct from the numeric types; a char is neither a u8 nor an i8. We describe Rust’s char type in [“Characters” on page 52](#).

The usize and isize types are analogous to size\_t and ptrdiff\_t in C and C++. The usize type is unsigned and isize is signed. Their precision depends on the size of the address space on the target machine: they are 32 bits long on 32-bit architectures, and 64 bits long on 64-bit architectures. Rust requires array indices to be usize

values. Values representing the sizes of arrays or vectors or counts of the number of elements in some data structure also generally have the `usize` type.

In debug builds, Rust checks for integer overflow in arithmetic:

```
let big_val = std::i32::MAX;
let x = big_val + 1; // panic: arithmetic operation overflowed
```

In a release build, this addition would wrap to a negative number (unlike C++, where signed integer overflow is undefined behavior). But unless you want to give up debug builds forever, it's a bad idea to count on it. When you want wrapping arithmetic, use the methods:

```
let x = big_val.wrapping_add(1); // ok
```

Integer literals in Rust can take a suffix indicating their type: `42u8` is a `u8` value, and `1729isize` is an `isize`. You can omit the suffix on an integer literal, in which case Rust will try to infer a type for it from the context. That inference usually identifies a unique type, but sometimes any one of several types would work. In this case, Rust defaults to `i32`, if that is among the possibilities. Otherwise, Rust reports the ambiguity as an error.

The prefixes `0x`, `0o`, and `0b` designate hexadecimal, octal, and binary literals.

To make long numbers more legible, you can insert underscores among the digits. For example, you can write the largest `u32` value as `4_294_967_295`. The exact placement of the underscores is not significant, so you can break hexadecimal or binary numbers into groups of four digits rather than three, as in `0xffff_ffff`, or set off the type suffix from the digits, as in `127_u8`.

Some examples of integer literals:

Literal	Type	Decimal value
<code>116i8</code>	<code>i8</code>	116
<code>0xcafeu32</code>	<code>u32</code>	51966
<code>0b0010_1010</code>	Inferred	42
<code>0o106</code>	Inferred	70

Although numeric types and the `char` type are distinct, Rust does provide *byte literals*, character-like literals for `u8` values: `b'X'` represents the ASCII code for the character `X`, as a `u8` value. For example, since the ASCII code for `A` is 65, the literals `b'A'` and `65u8` are exactly equivalent. Only ASCII characters may appear in byte literals.

There are a few characters that you cannot simply place after the single quote, because that would be either syntactically ambiguous or hard to read. The following characters require a backslash placed in front of them:

Character	Byte literal	Numeric equivalent
Single quote, '	b'\''	39u8
Backslash, \	b'\''	92u8
Newline	b'\n'	10u8
Carriage return	b'\r'	13u8
Tab	b'\t'	9u8

For characters that are hard to write or read, you can write their code in hexadecimal instead. A byte literal of the form `b'\xHH'`, where HH is any two-digit hexadecimal number, represents the byte whose value is HH. For example, you can write a byte literal for the ASCII “escape” control character as `b'\x1b'`, since the ASCII code for “escape” is 27, or 1B in hexadecimal. Since byte literals are just another notation for `u8` values, consider whether a simple numeric literal might be more legible: it probably makes sense to use `b'\x1b'` instead of simply 27 only when you want to emphasize that the value represents an ASCII code.

You can convert from one integer type to another using the `as` operator. We explain how conversions work in “Type Casts” on page 139, but here are some examples:

```
assert_eq!( 10_i8 as u16, 10_u16); // in range
assert_eq!( 2525_u16 as i16, 2525_i16); // in range

assert_eq!( -1_i16 as i32, -1_i32); // sign-extended
assert_eq!(65535_u16 as i32, 65535_i32); // zero-extended

// Conversions that are out of range for the destination
// produce values that are equivalent to the original modulo 2^N,
// where N is the width of the destination in bits. This
// is sometimes called "truncation".
assert_eq!( 1000_i16 as u8, 232_u8);
assert_eq!(65535_u32 as i16, -1_i16);

assert_eq!( -1_i8 as u8, 255_u8);
assert_eq!( 255_u8 as i8, -1_i8);
```

Like any other sort of value, integers can have methods. The standard library provides some basic operations, which you can look up in the online documentation. Note that the documentation contains separate pages for the type itself (search for “`i32` (primitive type)”, say), and for the module dedicated to that type (search for “`std::i32`”). For example:

```
assert_eq!(2u16.pow(4), 16); // exponentiation
assert_eq!((-4i32).abs(), 4); // absolute value
assert_eq!(0b101101u8.count_ones(), 4); // population count
```

The type suffixes on the literals are required here: Rust can’t look up a value’s methods until it knows its type. In real code, however, there’s usually additional context to disambiguate the type, so the suffixes aren’t needed.

# Floating-Point Types

Rust provides IEEE single- and double-precision floating-point types. Following the IEEE 754-2008 specification, these types include positive and negative infinities, distinct positive and negative zero values, and a *not-a-number* value:

Type	Precision	Range
f32	IEEE single precision (at least 6 decimal digits)	Roughly $-3.4 \times 10^{38}$ to $+3.4 \times 10^{38}$
f64	IEEE double precision (at least 15 decimal digits)	Roughly $-1.8 \times 10^{308}$ to $+1.8 \times 10^{308}$

Rust's f32 and f64 correspond to the float and double types in C and C++ implementations that support IEEE floating point, and in Java, which always uses IEEE floating point.

Floating-point literals have the general form diagrammed in Figure 3-1.

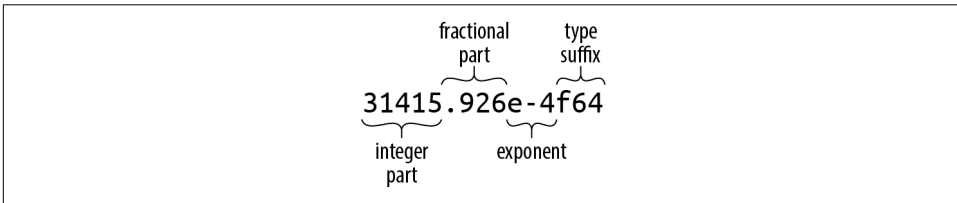

Figure 3-1. A floating-point literal

Every part of a floating-point number after the integer part is optional, but at least one of the fractional part, exponent, or type suffix must be present, to distinguish it from an integer literal. The fractional part may consist of a lone decimal point, so `5.` is a valid floating-point constant.

If a floating-point literal lacks a type suffix, Rust infers whether it is an f32 or f64 from the context, defaulting to f64 if both would be possible. (Similarly, C, C++, and Java all treat unsuffixed floating-point literals as double values.) For the purposes of type inference, Rust treats integer literals and floating-point literals as distinct classes: it will never infer a floating-point type for an integer literal, or vice versa.

Some examples of floating-point literals:

Literal	Type	Mathematical value
<code>-1.5625</code>	Inferred	$-(1 \frac{9}{16})$
<code>2.</code>	Inferred	2
<code>0.25</code>	Inferred	$\frac{1}{4}$
<code>1e4</code>	Inferred	10,000
<code>40f32</code>	f32	40
<code>9.109_383_56e-31f64</code>	f64	Roughly $9.10938356 \times 10^{-31}$



The standard library's `std::f32` and `std::f64` modules define constants for the IEEE-required special values like `INFINITY`, `NEG_INFINITY` (negative infinity), `NAN` (the not-a-number value), and `MIN` and `MAX` (the largest and smallest finite values). The `std::f32::consts` and `std::f64::consts` modules provide various commonly used mathematical constants like `E`, `PI`, and the square root of two.

The `f32` and `f64` types provide a full complement of methods for mathematical calculations; for example, `2f64.sqrt()` is the double-precision square root of two. The standard library documentation describes these under the names “`f32` (primitive type)” and “`f64` (primitive type)”. Some examples:

```
assert_eq!(5f32.sqrt() * 5f32.sqrt(), 5.); // exactly 5.0, per IEEE
assert_eq!(-1.01f64.floor(), -1.0);
assert!((-1. / std::f32::INFINITY).is_sign_negative());
```

As before, you usually won't need to write out the suffixes in real code, because the context will determine the type. When it doesn't, however, the error messages can be surprising. For example, the following doesn't compile:

```
println!("{}", (2.0).sqrt());
```

Rust complains:

```
error: no method named `sqrt` found for type `{float}` in the current scope
```

This can be a little bewildering; where else but on a floating-point type would one expect to find a `sqrt` method? The solution is to spell out which type you intend, in one way or another:

```
println!("{}", (2.0_f64).sqrt());
println!("{}", f64::sqrt(2.0));
```

Unlike C and C++, Rust performs almost no numeric conversions implicitly. If a function expects an `f64` argument, it's an error to pass an `i32` value as the argument. In fact, Rust won't even implicitly convert an `i16` value to an `i32` value, even though every `i16` value is also an `i32` value. But the key word here is *implicitly*: you can always write out *explicit* conversions using the `as` operator: `i` as `f64`, or `x` as `i32`. The lack of implicit conversions sometimes makes a Rust expression more verbose than the analogous C or C++ code would be. However, implicit integer conversions have a well-established record of causing bugs and security holes; in our experience, the act of writing out numeric conversions in Rust has alerted us to problems we would otherwise have missed. We explain exactly how conversions behave in “[Type Casts](#)” on page 139.

## The bool Type

Rust's Boolean type, `bool`, has the usual two values for such types, `true` and `false`. Comparison operators like `==` and `<` produce `bool` results: the value of `2 < 5` is `true`.

Many languages are lenient about using values of other types in contexts that require a Boolean value: C and C++ implicitly convert characters, integers, floating-point numbers, and pointers to Boolean values, so they can be used directly as the condition in an `if` or `while` statement. Python permits strings, lists, dictionaries, and even sets in Boolean contexts, treating such values as `true` if they're nonempty. Rust, however, is very strict: control structures like `if` and `while` require their conditions to be `bool` expressions, as do the short-circuiting logical operators `&&` and `||`. You must write `if x != 0 { ... }`, not simply `if x { ... }`.

Rust's `as` operator can convert `bool` values to integer types:

```
assert_eq!(false as i32, 0);
assert_eq!(true as i32, 1);
```

However, `as` won't convert in the other direction, from numeric types to `bool`. Instead, you must write out an explicit comparison like `x != 0`.

Although a `bool` only needs a single bit to represent it, Rust uses an entire byte for a `bool` value in memory, so you can create a pointer to it.

## Characters

Rust's character type `char` represents a single Unicode character, as a 32-bit value.

Rust uses the `char` type for single characters in isolation, but uses the UTF-8 encoding for strings and streams of text. So, a `String` represents its text as a sequence of UTF-8 bytes, not as an array of characters.

Character literals are characters enclosed in single quotes, like `'8'` or `'!'`. You can use any Unicode character you like: `'錆'` is a `char` literal representing the Japanese kanji for *sabi* (rust).

As with byte literals, backslash escapes are required for a few characters:

Character	Rust character literal
Single quote, <code>'</code>	<code>'\''</code>
Backslash, <code>\</code>	<code>'\\'</code>
Newline	<code>'\n'</code>
Carriage return	<code>'\r'</code>
Tab	<code>'\t'</code>

If you prefer, you can write out a character's Unicode code point in hexadecimal:

- If the character's code point is in the range U+0000 to U+007F (that is, if it is drawn from the ASCII character set), then you can write the character as `'\xHH'`, where `HH` is a two-digit hexadecimal number. For example, the character literals

'\*' and '\x2A' are equivalent, because the code point of the character \* is 42, or 2A in hexadecimal.

- You can write any Unicode character as '\u{HHHHHH}', where HHHHHH is a hexadecimal number between one and six digits long. For example, the character literal '\u{CA0}' represents the character “ಠ”, a Kannada character used in the Unicode Look of Disapproval, “ಠ\_ಠ”. The same literal could also be simply written as 'ಠ'.

A char always holds a Unicode code point in the range 0x0000 to 0xD7FF, or 0xE000 to 0x10FFFF. A char is never a surrogate pair half (that is, a code point in the range 0xD800 to 0xDFFF), or a value outside the Unicode codespace (that is, greater than 0x10FFFF). Rust uses the type system and dynamic checks to ensure char values are always in the permitted range.

Rust never implicitly converts between char and any other type. You can use the as conversion operator to convert a char to an integer type; for types smaller than 32 bits, the upper bits of the character’s value are truncated:

```
assert_eq!('*' as i32, 42);
assert_eq!('ಠ' as u16, 0xca0);
assert_eq!('ಠ' as i8, -0x60); // U+0CA0 truncated to eight bits, signed
```

Going in the other direction, u8 is the only type the as operator will convert to char: Rust intends the as operator to perform only cheap, infallible conversions, but every integer type other than u8 includes values that are not permitted Unicode code points, so those conversions would require runtime checks. Instead, the standard library function std::char::from\_u32 takes any u32 value and returns an Option<char>: if the u32 is not a permitted Unicode code point, then from\_u32 returns None; otherwise, it returns Some(c), where c is the char result.

The standard library provides some useful methods on characters, which you can look up in the online documentation by searching for “char (primitive type)”, and for the module “std::char”. For example:

```
assert_eq!('*'.is_alphabetic(), false);
assert_eq!('β'.is_alphabetic(), true);
assert_eq!('8'.to_digit(10), Some(8));
assert_eq!('ಠ'.len_utf8(), 3);
assert_eq!(std::char::from_digit(2, 10), Some('2'));
```

Naturally, single characters in isolation are not as interesting as strings and streams of text. We’ll describe Rust’s standard String type and text handling in general in “String Types” on page 64.

# Tuples

A *tuple* is a pair, or triple, or quadruple, ... of values of assorted types. You can write a tuple as a sequence of elements, separated by commas and surrounded by parentheses. For example, ("Brazil", 1985) is a tuple whose first element is a statically allocated string, and whose second is an integer; its type is (&str, i32) (or whatever integer type Rust infers for 1985). Given a tuple value `t`, you can access its elements as `t.0`, `t.1`, and so on.

Tuples aren't much like arrays: for one thing, each element of a tuple can have a different type, whereas an array's elements must be all the same type. Further, tuples allow only constants as indices, like `t.4`. You can't write `t.i` or `t[i]` to get the *i*'th element.

Rust code often uses tuple types to return multiple values from a function. For example, the `split_at` method on string slices, which divides a string into two halves and returns them both, is declared like this:

```
fn split_at(&self, mid: usize) -> (&str, &str);
```

The return type (&str, &str) is a tuple of two string slices. You can use pattern-matching syntax to assign each element of the return value to a different variable:

```
let text = "I see the eigenvalue in thine eye";
let (head, tail) = text.split_at(21);
assert_eq!(head, "I see the eigenvalue ");
assert_eq!(tail, "in thine eye");
```

This is more legible than the equivalent:

```
let text = "I see the eigenvalue in thine eye";
let temp = text.split_at(21);
let head = temp.0;
let tail = temp.1;
assert_eq!(head, "I see the eigenvalue ");
assert_eq!(tail, "in thine eye");
```

You'll also see tuples used as a sort of minimal-drama struct type. For example, in the Mandelbrot program in [Chapter 2](#), we need to pass the width and height of the image to the functions that plot it and write it to disk. We could declare a struct with `width` and `height` members, but that's pretty heavy notation for something so obvious, so we just used a tuple:

```
/// Write the buffer `pixels`, whose dimensions are given by `bounds`, to the
/// file named `filename`.
fn write_image(filename: &str, pixels: &[u8], bounds: (usize, usize))
    -> Result<(), std::io::Error>
{ ... }
```

The type of the bounds parameter is `(usize, usize)`, a tuple of two `usize` values. Admittedly, we could just as well write out separate `width` and `height` parameters, and the machine code would be about the same either way. It's a matter of clarity. We think of the size as one value, not two, and using a tuple lets us write what we mean.

The other commonly used tuple type, perhaps surprisingly, is the zero-tuple `()`. This is traditionally called the *unit type* because it has only one value, also written `()`. Rust uses the unit type where there's no meaningful value to carry, but context requires some sort of type nonetheless.

For example, a function that returns no value has a return type of `()`. The standard library's `std::mem::swap` function has no meaningful return value; it just exchanges the values of its two arguments. The declaration for `std::mem::swap` reads:

```
fn swap<T>(x: &mut T, y: &mut T);
```

The `<T>` means that `swap` is *generic*: you can use it on references to values of any type `T`. But the signature omits the `swap`'s return type altogether, which is shorthand for returning the unit type:

```
fn swap<T>(x: &mut T, y: &mut T) -> ();
```

Similarly, the `write_bitmap` example we mentioned before has a return type of `Result<(), std::io::Error>`, meaning that the function returns a `std::io::Error` value if something goes wrong, but returns no value on success.

If you like, you may include a comma after a tuple's last element: the types `(&str, i32,)` and `(&str, i32)` are equivalent, as are the expressions `("Brazil", 1985,)` and `("Brazil", 1985)`. Rust consistently permits an extra trailing comma everywhere commas are used: function arguments, arrays, struct and enum definitions, and so on. This may look odd to human readers, but it can make diffs easier to read when entries are added and removed at the end of a list.

For consistency's sake, there are even tuples that contain a single value. The literal `("lonely hearts",)` is a tuple containing a single string; its type is `(&str,)`. Here, the comma after the value is necessary to distinguish the singleton tuple from a simple parenthetic expression.

## Pointer Types

Rust has several types that represent memory addresses.

This is a big difference between Rust and most languages with garbage collection. In Java, if class `Tree` contains a field `Tree left`;, then `left` is a reference to another separately created `Tree` object. Objects never physically contain other objects in Java.

Rust is different. The language is designed to help keep allocations to a minimum. Values nest by default. The value `((0, 0), (1440, 900))` is stored as four adjacent integers. If you store it in a local variable, you've got a local variable four integers wide. Nothing is allocated in the heap.

This is great for memory efficiency, but as a consequence, when a Rust program needs values to point to other values, it must use pointer types explicitly. The good news is that the pointer types used in safe Rust are constrained to eliminate undefined behavior, so pointers are much easier to use correctly in Rust than in C++.

We'll discuss three pointer types here: references, boxes, and unsafe pointers.

## References

A value of type `&String` (pronounced “ref String”) is a reference to a `String` value, a `&i32` is a reference to an `i32`, and so on.

It's easiest to get started by thinking of references as Rust's basic pointer type. A reference can point to any value anywhere, stack or heap. The expression `&x` produces a reference to `x`; in Rust terminology, we say that it *borrow*s a reference to `x`. Given a reference `r`, the expression `*r` refers to the value `r` points to. These are very much like the `&` and `*` operators in C and C++. And like a C pointer, a reference does not automatically free any resources when it goes out of scope.

Unlike C pointers, however, Rust references are never null: there is simply no way to produce a null reference in safe Rust. And Rust references are immutable by default:

`&T`

Immutable reference, like `const T*` in C.

`&mut T`

Mutable reference, like `T*` in C.

Another major difference is that Rust tracks the ownership and lifetimes of values, so mistakes like dangling pointers, double frees, and pointer invalidation are ruled out at compile time. [Chapter 5](#) explains Rust's rules for safe reference use.

## Boxes

The simplest way to allocate a value in the heap is to use `Box::new`:

```
let t = (12, "eggs");
let b = Box::new(t); // allocate a tuple in the heap
```

The type of `t` is `(i32, &str)`, so the type of `b` is `Box<(i32, &str)>`. `Box::new()` allocates enough memory to contain the tuple on the heap. When `b` goes out of scope, the memory is freed immediately, unless `b` has been *moved*—by returning it, for example.

Moves are essential to the way Rust handles heap-allocated values; we explain all this in detail in [Chapter 4](#).

## Raw Pointers

Rust also has the raw pointer types `*mut T` and `*const T`. Raw pointers really are just like pointers in C++. Using a raw pointer is unsafe, because Rust makes no effort to track what it points to. For example, raw pointers may be null, or they may point to memory that has been freed or that now contains a value of a different type. All the classic pointer mistakes of C++ are offered for your enjoyment.

However, you may only dereference raw pointers within an `unsafe` block. An `unsafe` block is Rust's opt-in mechanism for advanced language features whose safety is up to you. If your code has no `unsafe` blocks (or if those it does have are written correctly), then the safety guarantees we emphasize throughout this book still hold. For details, see [Chapter 21](#).

## Arrays, Vectors, and Slices

Rust has three types for representing a sequence of values in memory:

- The type `[T; N]` represents an array of `N` values, each of type `T`. An array's size is a constant determined at compile time, and is part of the type; you can't append new elements, or shrink an array.
- The type `Vec<T>`, called a *vector of Ts*, is a dynamically allocated, growable sequence of values of type `T`. A vector's elements live on the heap, so you can resize vectors at will: push new elements onto them, append other vectors to them, delete elements, and so on.
- The types `&[T]` and `&mut [T]`, called a *shared slice of Ts* and *mutable slice of Ts*, are references to a series of elements that are a part of some other value, like an array or vector. You can think of a slice as a pointer to its first element, together with a count of the number of elements you can access starting at that point. A mutable slice `&mut [T]` lets you read and modify elements, but can't be shared; a shared slice `&[T]` lets you share access among several readers, but doesn't let you modify elements.

Given a value `v` of any of these three types, the expression `v.len()` gives the number of elements in `v`, and `v[i]` refers to the `i`'th element of `v`. The first element is `v[0]`, and the last element is `v[v.len() - 1]`. Rust checks that `i` always falls within this range; if it doesn't, the expression panics. The length of `v` may be zero, in which case any attempt to index it will panic. `i` must be a `usize` value; you can't use any other integer type as an index.

## Arrays

There are several ways to write array values. The simplest is to write a series of values within square brackets:

```
let lazy_caterer: [u32; 6] = [1, 2, 4, 7, 11, 16];
let taxonomy = ["Animalia", "Arthropoda", "Insecta"];

assert_eq!(lazy_caterer[3], 7);
assert_eq!(taxonomy.len(), 3);
```

For the common case of a long array filled with some value, you can write `[V; N]`, where `V` is the value each element should have, and `N` is the length. For example, `[true; 10000]` is an array of 10,000 `bool` elements, all set to `true`:

```
let mut sieve = [true; 10000];
for i in 2..100 {
    if sieve[i] {
        let mut j = i * i;
        while j < 10000 {
            sieve[j] = false;
            j += i;
        }
    }
}

assert!(sieve[211]);
assert!(!sieve[9876]);
```

You'll see this syntax used for fixed-size buffers: `[0u8; 1024]` can be a one-kilobyte buffer, filled with zero bytes. Rust has no notation for an uninitialized array. (In general, Rust ensures that code can never access any sort of uninitialized value.)

An array's length is part of its type and fixed at compile time. If `n` is a variable, you can't write `[true; n]` to get an array of `n` elements. When you need an array whose length varies at runtime (and you usually do), use a vector instead.

The useful methods you'd like to see on arrays—iterating over elements, searching, sorting, filling, filtering, and so on—all appear as methods of slices, not arrays. But Rust implicitly converts a reference to an array to a slice when searching for methods, so you can call any slice method on an array directly:

```
let mut chaos = [3, 5, 4, 1, 2];
chaos.sort();
assert_eq!(chaos, [1, 2, 3, 4, 5]);
```

Here, the `sort` method is actually defined on slices, but since `sort` takes its operand by reference, we can use it directly on `chaos`: the call implicitly produces a `&mut [i32]` slice referring to the entire array. In fact, the `len` method we mentioned earlier is a slice method as well. We cover slices in more detail in [“Slices” on page 62](#).



## Vectors

A vector `Vec<T>` is a resizable array of elements of type `T`, allocated on the heap.

There are several ways to create vectors. The simplest is to use the `vec!` macro, which gives us a syntax for vectors that looks very much like an array literal:

```
let mut v = vec![2, 3, 5, 7];
assert_eq!(v.iter().fold(1, |a, b| a * b), 210);
```

But of course, this is a vector, not an array, so we can add elements to it dynamically:

```
v.push(11);
v.push(13);
assert_eq!(v.iter().fold(1, |a, b| a * b), 30030);
```

You can also build a vector by repeating a given value a certain number of times, again using a syntax that imitates array literals:

```
fn new_pixel_buffer(rows: usize, cols: usize) -> Vec<u8> {
    vec![0; rows * cols]
}
```

The `vec!` macro is equivalent to calling `Vec::new` to create a new, empty vector, and then pushing the elements onto it, which is another idiom:

```
let mut v = Vec::new();
v.push("step");
v.push("on");
v.push("no");
v.push("pets");
assert_eq!(v, vec!["step", "on", "no", "pets"]);
```

Another possibility is to build a vector from the values produced by an iterator:

```
let v: Vec<i32> = (0..5).collect();
assert_eq!(v, [0, 1, 2, 3, 4]);
```

You'll often need to supply the type when using `collect` (as we've done here), because it can build many different sorts of collections, not just vectors. By making the type for `v` explicit, we've made it unambiguous which sort of collection we want.

As with arrays, you can use slice methods on vectors:

```
// A palindrome!
let mut v = vec!["a man", "a plan", "a canal", "panama"];
v.reverse();
// Reasonable yet disappointing:
assert_eq!(v, vec!["panama", "a canal", "a plan", "a man"]);
```

Here, the `reverse` method is actually defined on slices, but the call implicitly borrows a `&mut [ &str ]` slice from the vector, and invokes `reverse` on that.

Vec is an essential type to Rust—it’s used almost anywhere one needs a list of dynamic size—so there are many other methods that construct new vectors or extend existing ones. We’ll cover them in [Chapter 16](#).

A `Vec<T>` consists of three values: a pointer to the heap-allocated buffer allocated to hold the elements; the number of elements that buffer has the capacity to store; and the number it actually contains now (in other words, its length). When the buffer has reached its capacity, adding another element to the vector entails allocating a larger buffer, copying the present contents into it, updating the vector’s pointer and capacity to describe the new buffer, and finally freeing the old one.

If you know the number of elements a vector will need in advance, instead of `Vec::new` you can call `Vec::with_capacity` to create a vector with a buffer large enough to hold them all, right from the start; then, you can add the elements to the vector one at a time without causing any reallocation. The `vec!` macro uses a trick like this, since it knows how many elements the final vector will have. Note that this only establishes the vector’s initial size; if you exceed your estimate, the vector simply enlarges its storage as usual.

Many library functions look for the opportunity to use `Vec::with_capacity` instead of `Vec::new`. For example, in the `collect` example, the iterator `0..5` knows in advance that it will yield five values, and the `collect` function takes advantage of this to pre-allocate the vector it returns with the correct capacity. We’ll see how this works in [Chapter 15](#).

Just as a vector’s `len` method returns the number of elements it contains now, its `capacity` method returns the number of elements it could hold without reallocation:

```
let mut v = Vec::with_capacity(2);
assert_eq!(v.len(), 0);
assert_eq!(v.capacity(), 2);

v.push(1);
v.push(2);
assert_eq!(v.len(), 2);
assert_eq!(v.capacity(), 2);

v.push(3);
assert_eq!(v.len(), 3);
assert_eq!(v.capacity(), 4);
```

The capacities you’ll see in your code may differ from those shown here. `Vec` and the system’s heap allocator may round up requests, even in the `with_capacity` case.

You can insert and remove elements wherever you like in a vector, although these operations shift all the elements after the insertion point forward or backward, so they may be slow if the vector is long:

```

let mut v = vec![10, 20, 30, 40, 50];

// Make the element at index 3 be 35.
v.insert(3, 35);
assert_eq!(v, [10, 20, 30, 35, 40, 50]);

// Remove the element at index 1.
v.remove(1);
assert_eq!(v, [10, 30, 35, 40, 50]);

```

You can use the `pop` method to remove the last element and return it. More precisely, popping a value from a `Vec<T>` returns an `Option<T>`: `None` if the vector was already empty, or `Some(v)` if its last element had been `v`:

```

let mut v = vec!["carmen", "miranda"];
assert_eq!(v.pop(), Some("miranda"));
assert_eq!(v.pop(), Some("carmen"));
assert_eq!(v.pop(), None);

```

You can use a `for` loop to iterate over a vector:

```

// Get our command-line arguments as a vector of Strings.
let languages: Vec<String> = std::env::args().skip(1).collect();
for l in languages {
    println!("{}", l,
        if l.len() % 2 == 0 {
            "functional"
        } else {
            "imperative"
        });
}

```

Running this program with a list of programming languages is illuminating:

```

$ cargo run Lisp Scheme C C++ Fortran
   Compiling fragments v0.1.0 (file:///home/jimb/rust/book/fragments)
   Running `.../target/debug/fragments Lisp Scheme C C++ Fortran`
Lisp: functional
Scheme: functional
C: imperative
C++: imperative
Fortran: imperative
$

```

Finally, a satisfying definition for the term *functional language*.

Despite its fundamental role, `Vec` is an ordinary type defined in Rust, not built into the language. We'll cover the techniques needed to implement such types in [Chapter 21](#).

## Building Vectors Element by Element

Building a vector one element at a time isn't as bad as it might sound. Whenever a vector outgrows its buffer's capacity, it chooses a new buffer twice as large as the old one. Suppose the vector starts with a buffer that can hold only one element: as it grows to its final capacity, it'll have buffers of size 1, 2, 4, 8, and so on until it reaches its final size of  $2^n$ , for some  $n$ . If you think about how powers of two work, you'll see that the total size of all the previous, smaller buffers put together is  $2^n - 1$ , very close to the final buffer size. Since the number of actual elements is at least half the buffer size, the vector has always performed less than two copies per element!

What this means is that using `Vec::with_capacity` instead of `Vec::new` is a way to gain a constant factor improvement in speed, rather than an algorithmic improvement. For small vectors, avoiding a few calls to the heap allocator can make an observable difference in performance.

## Slices

A slice, written `[T]` without specifying the length, is a region of an array or vector. Since a slice can be any length, slices can't be stored directly in variables or passed as function arguments. Slices are always passed by reference.

A reference to a slice is a *fat pointer*: a two-word value comprising a pointer to the slice's first element, and the number of elements in the slice.

Suppose you run the following code:

```
let v: Vec<f64> = vec![0.0, 0.707, 1.0, 0.707];
let a: [f64; 4] = [0.0, -0.707, -1.0, -0.707];

let sv: &[f64] = &v;
let sa: &[f64] = &a;
```

On the last two lines, Rust automatically converts the `&Vec<f64>` reference and the `&[f64; 4]` reference to slice references that point directly to the data.

By the end, memory looks like [Figure 3-2](#).

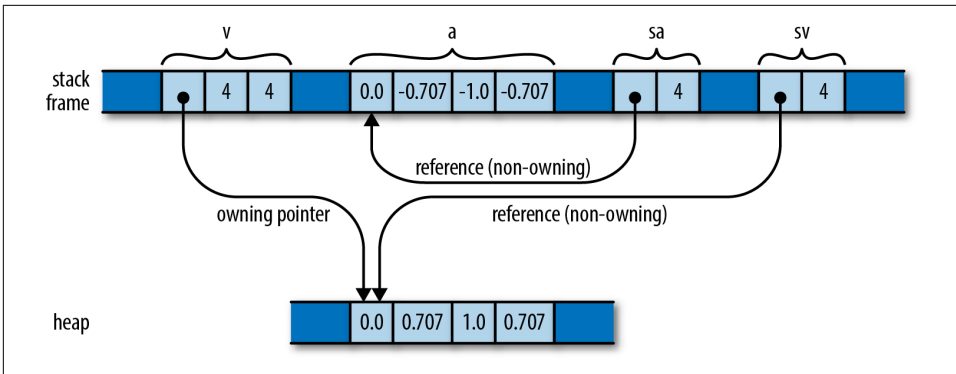

Figure 3-2. A vector `v` and an array `a` in memory, with slices `sa` and `sv` referring to each

Whereas an ordinary reference is a non-owning pointer to a single value, a reference to a slice is a non-owning pointer to several values. This makes slice references a good choice when you want to write a function that operates on any homogeneous data series, whether stored in an array, vector, stack, or heap. For example, here's a function that prints a slice of numbers, one per line:

```
fn print(n: &[f64]) {
    for elt in n {
        println!("{}", elt);
    }
}

print(&v); // works on vectors
print(&a); // works on arrays
```

Because this function takes a slice reference as an argument, you can apply it to either a vector or an array, as shown. In fact, many methods you might think of as belonging to vectors or arrays are actually methods defined on slices: for example, the `sort` and `reverse` methods, which sort or reverse a sequence of elements in place, are actually methods on the slice type `[T]`.

You can get a reference to a slice of an array or vector, or a slice of an existing slice, by indexing it with a range:

```
print(&v[0..2]); // print the first two elements of v
print(&a[2..]); // print elements of a starting with a[2]
print(&sv[1..3]); // print v[1] and v[2]
```

As with ordinary array accesses, Rust checks that the indices are valid. Trying to borrow a slice that extends past the end of the data results in a panic.

We often use the term *slice* for reference types like `&[T]` or `&str`, but that is a bit of shorthand: those are properly called *references to slices*. Since slices almost always appear behind references, we use the shorter name for the more common concept.

# String Types

Programmers familiar with C++ will recall that there are two string types in the language. String literals have the pointer type `const char *`. The standard library also offers a class, `std::string`, for dynamically creating strings at runtime.

Rust has a similar design. In this section, we'll show all the ways to write string literals, then introduce Rust's two string types. We provide more detail about strings and text handling in [Chapter 17](#).

## String Literals

String literals are enclosed in double quotes. They use the same backslash escape sequences as char literals:

```
let speech = "\"Ouch!\" said the well.\n";
```

In string literals, unlike char literals, single quotes don't need a backslash escape, and double quotes do.

A string may span multiple lines:

```
println!("In the room the women come and go,  
Singing of Mount Abora");
```

The newline character in that string literal is included in the string, and therefore in the output. So are the spaces at the beginning of the second line.

If one line of a string ends with a backslash, then the newline character and the leading whitespace on the next line are dropped:

```
println!("It was a bright, cold day in April, and \\  
there were four of us-\\  
more or less.");
```

This prints a single line of text. The string contains a single space between “and” and “there”, because there is a space before the backslash in the program, and no space after the dash.

In a few cases, the need to double every backslash in a string is a nuisance. (The classic examples are regular expressions and Windows paths.) For these cases, Rust offers *raw strings*. A raw string is tagged with the lowercase letter `r`. All backslashes and whitespace characters inside a raw string are included verbatim in the string. No escape sequences are recognized.

```
let default_win_install_path = r"C:\Program Files\Gorillas";  
  
let pattern = Regex::new(r"\d+(\.\d+)*");
```

You can't include a double-quote character in a raw string simply by putting a backslash in front of it—remember, we said *no* escape sequences are recognized. However, there is a cure for that too. The start and end of a raw string can be marked with pound signs:

```
println!(r###"  
    This raw string started with 'r###'.  
    Therefore it does not end until we reach a quote mark ('')  
    followed immediately by three pound signs ('###'):  
    ###");
```

You can add as few or as many pound signs as needed to make it clear where the raw string ends.

## Byte Strings

A string literal with the `b` prefix is a *byte string*. Such a string is a slice of `u8` values—that is, bytes—rather than Unicode text:

```
let method = b"GET";  
assert_eq!(method, &[b'G', b'E', b'T']);
```

This combines with all the other string syntax we've shown: byte strings can span multiple lines, use escape sequences, and use backslashes to join lines. Raw byte strings start with `br`.

Byte strings can't contain arbitrary Unicode characters. They must make do with ASCII and `\xHH` escape sequences.

The type of `method` shown here is `&[u8; 3]`: it's a reference to an array of three bytes. It doesn't have any of the string methods we'll discuss in a minute. The most string-like thing about it is the syntax we used to write it.

## Strings in Memory

Rust strings are sequences of Unicode characters, but they are not stored in memory as arrays of `chars`. Instead, they are stored using UTF-8, a variable-width encoding. Each ASCII character in a string is stored in one byte. Other characters take up multiple bytes.

Figure 3-3 shows the `String` and `&str` values created by the code:

```
let noodles = "noodles".to_string();  
let oodles = &noodles[1..];  
let poodles = "🐕_🐕";
```

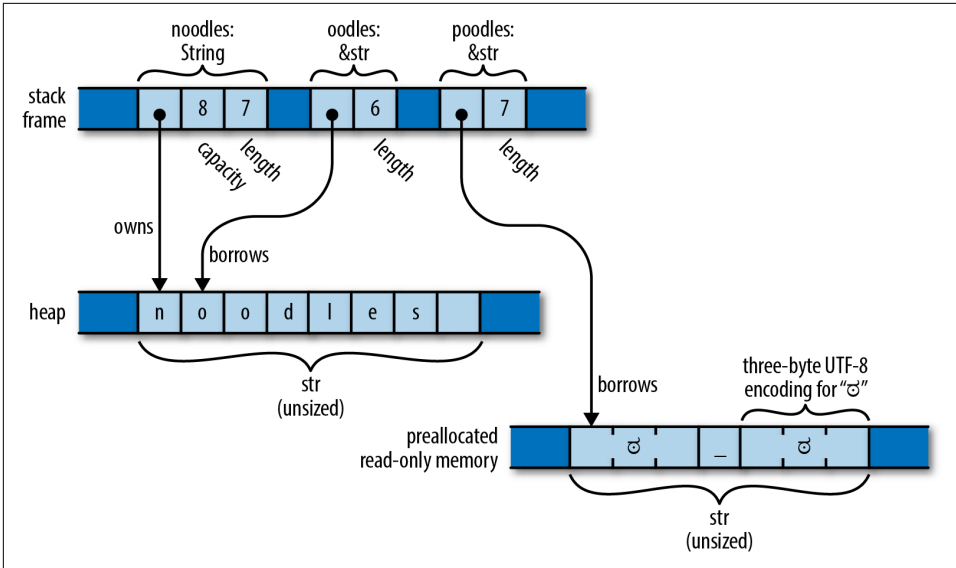

Figure 3-3. `String`, `&str`, and `str`

A `String` has a resizable buffer holding UTF-8 text. The buffer is allocated on the heap, so it can resize its buffer as needed or requested. In the example, `noodles` is a `String` that owns an eight-byte buffer, of which seven are in use. You can think of a `String` as a `Vec<u8>` that is guaranteed to hold well-formed UTF-8; in fact, this is how `String` is implemented.

A `&str` (pronounced “stir” or “string slice”) is a reference to a run of UTF-8 text owned by someone else: it “borrows” the text. In the example, `oodles` is a `&str` referring to the last six bytes of the text belonging to `noodles`, so it represents the text “oodles”. Like other slice references, a `&str` is a fat pointer, containing both the address of the actual data and its length. You can think of a `&str` as being nothing more than a `&[u8]` that is guaranteed to hold well-formed UTF-8.

A string literal is a `&str` that refers to preallocated text, typically stored in read-only memory along with the program’s machine code. In the preceding example, `poodles` is a string literal, pointing to seven bytes that are created when the program begins execution, and that last until it exits.

A `String` or `&str`’s `.len()` method returns its length. The length is measured in bytes, not characters:

```
assert_eq!("🐼_🐼".len(), 7);
assert_eq!("🐼_🐼".chars().count(), 3);
```

It is impossible to modify a `&str`:



```
let mut s = "hello";
s[0] = 'c'; // error: the type `str` cannot be mutably indexed
s.push('\n'); // error: no method named `push` found for type `&str`
```

For creating new strings at run time, use `String`.

The type `&mut str` does exist, but it is not very useful, since almost any operation on UTF-8 can change its overall byte length, and a slice cannot reallocate its referent. In fact, the only operations available on `&mut str` are `make_ascii_uppercase` and `make_ascii_lowercase`, which modify the text in place and affect only single-byte characters, by definition.

## String

`&str` is very much like `&[T]`: a fat pointer to some data. `String` is analogous to `Vec<T>`:

	<code>Vec&lt;T&gt;</code>	<code>String</code>
Automatically frees buffers	Yes	Yes
Growable	Yes	Yes
<code>::new()</code> and <code>::with_capacity()</code> static methods	Yes	Yes
<code>.reserve()</code> and <code>.capacity()</code> methods	Yes	Yes
<code>.push()</code> and <code>.pop()</code> methods	Yes	Yes
Range syntax <code>v[start..stop]</code>	Yes, returns <code>&amp;[T]</code>	Yes, returns <code>&amp;str</code>
Automatic conversion	<code>&amp;Vec&lt;T&gt;</code> to <code>&amp;[T]</code>	<code>&amp;String</code> to <code>&amp;str</code>
Inherits methods	From <code>&amp;[T]</code>	From <code>&amp;str</code>

Like a `Vec`, each `String` has its own heap-allocated buffer that isn't shared with any other `String`. When a `String` variable goes out of scope, the buffer is automatically freed, unless the `String` was moved.

There are several ways to create `Strings`:

- The `.to_string()` method converts a `&str` to a `String`. This copies the string:

```
let error_message = "too many pets".to_string();
```

- The `format!()` macro works just like `println!()`, except that it returns a new `String` instead of writing text to `stdout`, and it doesn't automatically add a new-line at the end.

```
assert_eq!(format!("{:02}'{:02}'N", 24, 5, 23),
           "24°05'23"N".to_string());
```

- Arrays, slices, and vectors of strings have two methods, `.concat()` and `.join(sep)`, that form a new `String` from many strings.

```
let bits = vec!["veni", "vidi", "vici"];
assert_eq!(bits.concat(), "venividivici");
assert_eq!(bits.join(", "), "veni, vidi, vici");
```

The choice sometimes arises of which type to use: `&str` or `String`. [Chapter 5](#) addresses this question in detail. For now it will suffice to point out that a `&str` can refer to any slice of any string, whether it is a string literal (stored in the executable) or a `String` (allocated and freed at run time). This means that `&str` is more appropriate for function arguments when the caller should be allowed to pass either kind of string.

## Using Strings

Strings support the `==` and `!=` operators. Two strings are equal if they contain the same characters in the same order (regardless of whether they point to the same location in memory).

```
assert!("ONE".to_lowercase() == "one");
```

Strings also support the comparison operators `<`, `<=`, `>`, and `>=`, as well as many useful methods and functions that you can find in the online documentation by searching for “`str` (primitive type)” or the “`std::str`” module (or just flip to [Chapter 17](#)). Here are a few examples:

```
assert!("peanut".contains("nut"));
assert_eq!("☺☺".replace("☺", "■"), "■_■");
assert_eq!("  clean\n".trim(), "clean");

for word in "veni, vidi, vici".split(", ") {
    assert!(word.starts_with("v"));
}
```

Keep in mind that, given the nature of Unicode, simple char-by-char comparison does *not* always give the expected answers. For example, the Rust strings `"th\u{e9}"` and `"the\u{301}"` are both valid Unicode representations for *thé*, the French word for tea. Unicode says they should both be displayed and processed in the same way, but Rust treats them as two completely distinct strings. Similarly, Rust’s ordering operators like `<` use a simple lexicographical order based on character code point values. This ordering only sometimes resembles the ordering used for text in the user’s language and culture. We discuss these issues in more detail in [Chapter 17](#).

## Other String-Like Types

Rust guarantees that strings are valid UTF-8. Sometimes a program really needs to be able to deal with strings that are *not* valid Unicode. This usually happens when a Rust program has to interoperate with some other system that doesn’t enforce any such rules. For example, in most operating systems it’s easy to create a file with a filename

that isn't valid Unicode. What should happen when a Rust program comes across this sort of filename?

Rust's solution is to offer a few string-like types for these situations:

- Stick to `String` and `&str` for Unicode text.
- When working with filenames, use `std::path::PathBuf` and `&Path` instead.
- When working with binary data that isn't character data at all, use `Vec<u8>` and `&[u8]`.
- When working with environment variable names and command-line arguments in the native form presented by the operating system, use `OsString` and `&OsStr`.
- When interoperating with C libraries that use null-terminated strings, use `std::ffi::CString` and `&CStr`.

## Beyond the Basics

Types are a central part of Rust. We'll continue talking about types and introducing new ones throughout the book. In particular, Rust's user-defined types give the language much of its flavor, because that's where methods are defined. There are three kinds of user-defined types, and we'll cover them in three successive chapters: structs in [Chapter 9](#), enums in [Chapter 10](#), and traits in [Chapter 11](#).

Functions and closures have their own types, covered in [Chapter 14](#). And the types that make up the standard library are covered throughout the book. For example, [Chapter 16](#) presents the standard collection types.

All of that will have to wait, though. Before we move on, it's time to tackle the concepts that are at the heart of Rust's safety rules.



---

# Ownership

*I've found that Rust has forced me to learn many of the things that I was slowly learning as 'good practice' in C/C++ before I could even compile my code. ...I want to stress that Rust isn't the kind of language you can learn in a couple days and just deal with the hard/technical/good-practice stuff later. You will be forced to learn strict safety immediately and it will probably feel uncomfortable at first. However in my own experience, this has led me towards feeling like compiling my code actually means something to me again.*

—Mitchell Nordine

Rust makes the following pair of promises, both essential to a safe systems programming language:

- You decide the lifetime of each value in your program. Rust frees memory and other resources belonging to a value promptly, at a point under your control.
- Even so, your program will never use a pointer to an object after it has been freed. Using a *dangling pointer* is a common mistake in C and C++: if you're lucky, your program crashes. If you're unlucky, your program has a security hole. Rust catches these mistakes at compile time.

C and C++ keep the first promise: you can call `free` or `delete` on any object in the dynamically allocated heap you like, whenever you like. But in exchange, the second promise is set aside: it is entirely your responsibility to ensure that no pointer to the value you freed is ever used. There's ample empirical evidence that this is a difficult responsibility to meet: pointer misuse has been a common culprit in public databases of reported security problems for as long as that data has been collected.

Plenty of languages fulfill the second promise using garbage collection, automatically freeing objects only when all reachable pointers to them are gone. But in exchange, you relinquish control to the collector over exactly when objects get freed. In general, garbage collectors are surprising beasts, and understanding why memory wasn't freed

when you expected can be a challenge. And if you're working with objects that represent files, network connections, or other operating system resources, not being able to trust that they'll be freed at the time you intended, and their underlying resources cleaned up along with them, is a disappointment.

None of these compromises are acceptable for Rust: the programmer should have control over values' lifetimes, *and* the language should be safe. But this is a pretty well-explored area of language design. You can't make major improvements without some fundamental changes.

Rust breaks the deadlock in a surprising way: by restricting how your programs can use pointers. This chapter and the next are devoted to explaining exactly what these restrictions are and why they work. For now, suffice it to say that some common structures you are accustomed to using may not fit within the rules, and you'll need to look for alternatives. But the net effect of these restrictions is to bring just enough order to the chaos to allow Rust's compile-time checks to verify that your program is free of memory safety errors: dangling pointers, double frees, using uninitialized memory, and so on. At runtime, your pointers are simple addresses in memory, just as they would be in C and C++. The difference is that your code has been proven to use them safely.

These same rules also form the basis of Rust's support for safe concurrent programming. Using Rust's carefully designed threading primitives, the rules that ensure your code uses memory correctly also serve to prove that it is free of data races. A bug in a Rust program cannot cause one thread to corrupt another's data, introducing hard-to-reproduce failures in unrelated parts of the system. The nondeterministic behavior inherent in multithreaded code is isolated to those features designed to handle it—mutexes, message channels, atomic values, and so on—rather than appearing in ordinary memory references. Multithreaded code in C and C++ has earned its ugly reputation, but Rust rehabilitates it quite nicely.

Rust's radical wager, the claim on which it stakes its success, and that forms the root of the language, is that even with these restrictions in place, you'll find the language more than flexible enough for almost every task, and that the benefits—the elimination of broad classes of memory management and concurrency bugs—will justify the adaptations you'll need to make to your style. The authors of this book are bullish on Rust exactly because of our extensive experience with C and C++. For us, Rust's deal is a no-brainer.

Rust's rules are probably unlike what you've seen in other programming languages. Learning how to work with them and turn them to your advantage is, in our opinion, the central challenge of learning Rust. In this chapter, we'll first motivate Rust's rules by showing how the same underlying issues play out in other languages. Then, we'll explain Rust's rules in detail. Finally, we'll talk about some exceptions and almost-exceptions.

# Ownership

If you've read much C or C++ code, you've probably come across a comment saying that an instance of some class *owns* some other object that it points to. This generally means that the owning object gets to decide when to free the owned object: when the owner is destroyed, it destroys its possessions along with it.

For example, suppose you write the following C++ code:

```
std::string s = "frayed knot";
```

The string `s` is usually represented in memory as shown in [Figure 4-1](#).

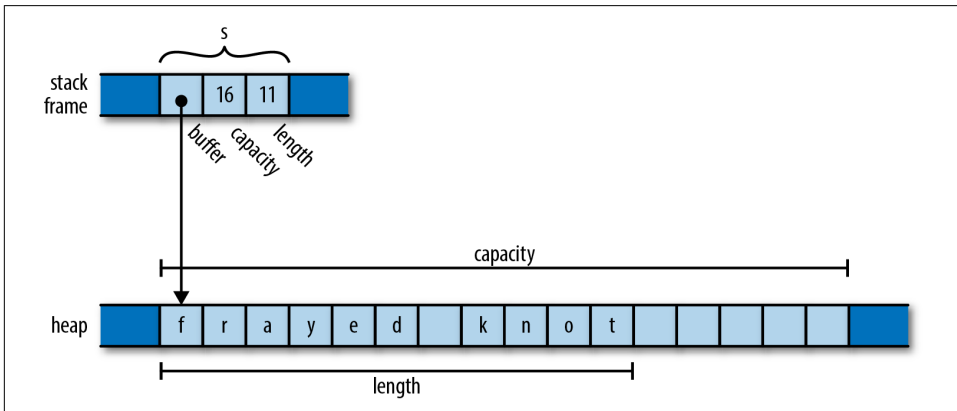

Figure 4-1. A C++ `std::string` value on the stack, pointing to its heap-allocated buffer

Here, the actual `std::string` object itself is always exactly three words long, comprising a pointer to a heap-allocated buffer, the buffer's overall capacity (that is, how large the text can grow before the string must allocate a larger buffer to hold it), and the length of the text it holds now. These are fields private to the `std::string` class, not accessible to the string's users.

A `std::string` owns its buffer: when the program destroys the string, the string's destructor frees the buffer. In the past, some C++ libraries shared a single buffer among several `std::string` values, using a reference count to decide when the buffer should be freed. Newer versions of the C++ specification effectively preclude that representation; all modern C++ libraries use the approach shown here. In these situations it's generally understood that, although it's fine for other code to create temporary pointers to the owned memory, it is that code's responsibility to make sure its pointers are gone before the owner decides to destroy the owned object. You can create a pointer to a character living in a `std::string`'s buffer, but when the string is destroyed, your pointer becomes invalid, and it's up to you to make sure you don't use

it anymore. The owner determines the lifetime of the owned, and everyone else must respect its decisions.

Rust takes this principle out of the comments and makes it explicit in the language. In Rust, every value has a single owner that determines its lifetime. When the owner is freed—*dropped*, in Rust terminology—the owned value is dropped too. These rules are meant to make it easy for you to find any given value’s lifetime simply by inspecting the code, giving you the control over its lifetime that a systems language should provide.

A variable owns its value. When control leaves the block in which the variable is declared, the variable is dropped, so its value is dropped along with it. For example:

```
fn print_padovan() {
    let mut padovan = vec![1,1,1]; // allocated here
    for i in 3..10 {
        let next = padovan[i-3] + padovan[i-2];
        padovan.push(next);
    }
    println!("P(1..10) = {:?}", padovan);
} // dropped here
```

The type of the variable `padovan` is `std::vec::Vec<i32>`, a vector of 32-bit integers. In memory, the final value of `padovan` will look something like [Figure 4-2](#).

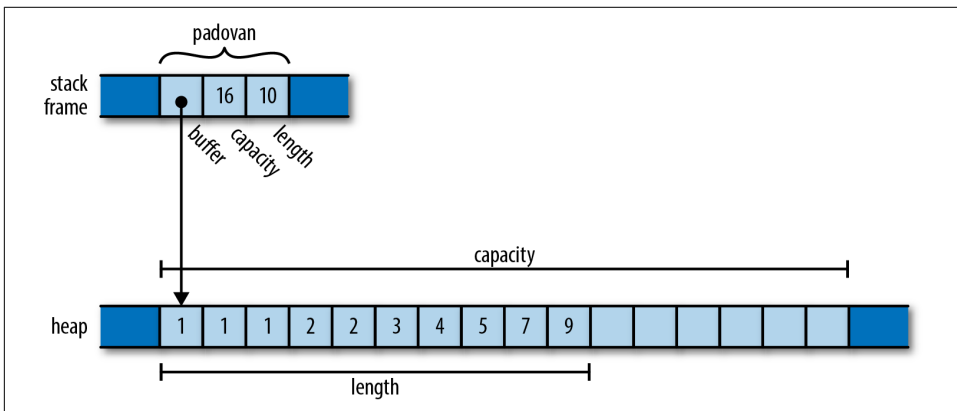

Figure 4-2. A `Vec 32` on the stack, pointing to its buffer in the heap

This is very similar to the C++ `std::string` we showed earlier, except that the elements in the buffer are 32-bit values, not characters. Note that the words holding `padovan`’s pointer, `capacity`, and `length` live directly in the stack frame of the `print_padovan` function; only the vector’s buffer is allocated on the heap.



As with the string `s` earlier, the vector owns the buffer holding its elements. When the variable `padovan` goes out of scope at the end of the function, the program drops the vector. And since the vector owns its buffer, the buffer goes with it.

Rust's `Box` type serves as another example of ownership. A `Box<T>` is a pointer to a value of type `T` stored on the heap. Calling `Box::new(v)` allocates some heap space, moves the value `v` into it, and returns a `Box` pointing to the heap space. Since a `Box` owns the space it points to, when the `Box` is dropped, it frees the space too.

For example, you can allocate a tuple in the heap like so:

```
{
    let point = Box::new((0.625, 0.5)); // point allocated here
    let label = format!("{:?}", point); // label allocated here
    assert_eq!(label, "(0.625, 0.5)");
} // both dropped here
```

When the program calls `Box::new`, it allocates space for a tuple of two `f64` values on the heap, moves its argument `(0.625, 0.5)` into that space, and returns a pointer to it. By the time control reaches the call to `assert_eq!`, the stack frame looks like [Figure 4-3](#).

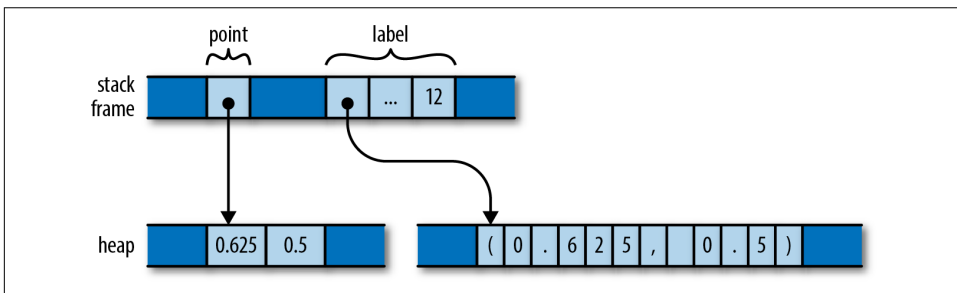

Figure 4-3. Two local variables, each owning memory in the heap

The stack frame itself holds the variables `point` and `label`, each of which refers to a heap allocation that it owns. When they are dropped, the allocations they own are freed along with them.

Just as variables own their values, structs own their fields; and tuples, arrays, and vectors own their elements:

```
struct Person { name: String, birth: i32 }

let mut composers = Vec::new();
composers.push(Person { name: "Palestrina".to_string(),
    birth: 1525 });
composers.push(Person { name: "Dowland".to_string(),
    birth: 1563 });
composers.push(Person { name: "Lully".to_string(),
```

```

        birth: 1632 });
for composer in &composers {
    println!("{}", born {}, composer.name, composer.birth);
}

```

Here, `composers` is a `Vec<Person>`, a vector of structs, each of which holds a string and a number. In memory, the final value of `composers` looks like [Figure 4-4](#).

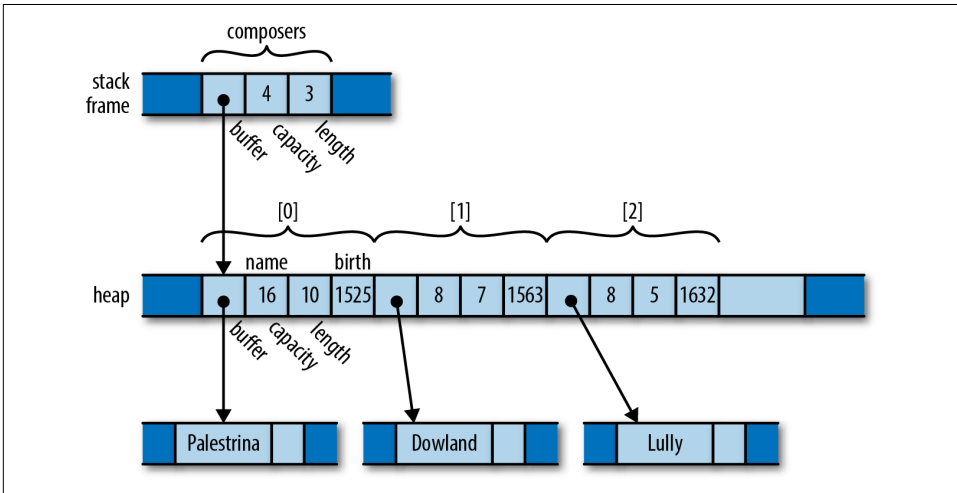

Figure 4-4. A more complex tree of ownership

There are many ownership relationships here, but each one is pretty straightforward: `composers` owns a vector; the vector owns its elements, each of which is a `Person` structure; each structure owns its fields; and the string field owns its text. When control leaves the scope in which `composers` is declared, the program drops its value, and takes the entire arrangement with it. If there were other sorts of collections in the picture—a `HashMap`, perhaps, or a `BTreeSet`—the story would be the same.

At this point, take a step back and consider the consequences of the ownership relations we’ve presented so far. Every value has a single owner, making it easy to decide when to drop it. But a single value may own many other values: for example, the vector `composers` owns all of its elements. And those values may own other values in turn: each element of `composers` owns a string, which owns its text.

It follows that the owners and their owned values form *trees*: your owner is your parent, and the values you own are your children. And at the ultimate root of each tree is a variable; when that variable goes out of scope, the entire tree goes with it. We can see such an ownership tree in the diagram for `composers`: it’s not a “tree” in the sense of a search tree data structure, or an HTML document made from DOM elements. Rather, we have a tree built from a mixture of types, with Rust’s single-owner rule forbidding any rejoining of structure that could make the arrangement more complex

than a tree. Every value in a Rust program is a member of some tree, rooted in some variable.

Rust programs don't usually explicitly drop values at all, in the way C and C++ programs would use `free` and `delete`. The way to drop a value in Rust is to remove it from the ownership tree somehow: by leaving the scope of a variable, or deleting an element from a vector, or something of that sort. At that point, Rust ensures the value is properly dropped, along with everything it owns.

In a certain sense, Rust is less powerful than other languages: every other practical programming language lets you build arbitrary graphs of objects that point to each other in whatever way you see fit. But it is exactly because Rust is less powerful that the analyses the language can carry out on your programs can be more powerful. Rust's safety guarantees are possible exactly because the relationships it may encounter in your code are more tractable. This is part of Rust's "radical wager" we mentioned earlier: in practice, Rust claims, there is usually more than enough flexibility in how one goes about solving a problem to ensure that at least a few perfectly fine solutions fall within the restrictions the language imposes.

That said, the story we've told so far is still much too rigid to be usable. Rust extends this picture in several ways:

- You can move values from one owner to another. This allows you to build, rearrange, and tear down the tree.
- The standard library provides the reference-counted pointer types `Rc` and `Arc`, which allow values to have multiple owners, under some restrictions.
- You can "borrow a reference" to a value; references are nonowning pointers, with limited lifetimes.

Each of these strategies contributes flexibility to the ownership model, while still upholding Rust's promises. We'll explain each one in turn, with references covered in the next chapter.

## Moves

In Rust, for most types, operations like assigning a value to a variable, passing it to a function, or returning it from a function don't copy the value: they *move* it. The source relinquishes ownership of the value to the destination, and becomes uninitialized; the destination now controls the value's lifetime. Rust programs build up and tear down complex structures one value at a time, one move at a time.

You may be surprised that Rust would change the meaning of such fundamental operations; surely assignment is something that should be pretty well nailed down at this point in history. However, if you look closely at how different languages have

chosen to handle assignment, you'll see that there's actually significant variation from one school to another. The comparison also makes the meaning and consequences of Rust's choice easier to see.

Consider the following Python code:

```
s = ['udon', 'ramen', 'soba']  
t = s  
u = s
```

Each Python object carries a reference count, tracking the number of values that are currently referring to it. So after the assignment to `s`, the state of the program looks like [Figure 4-5](#) (note that some fields are left out).

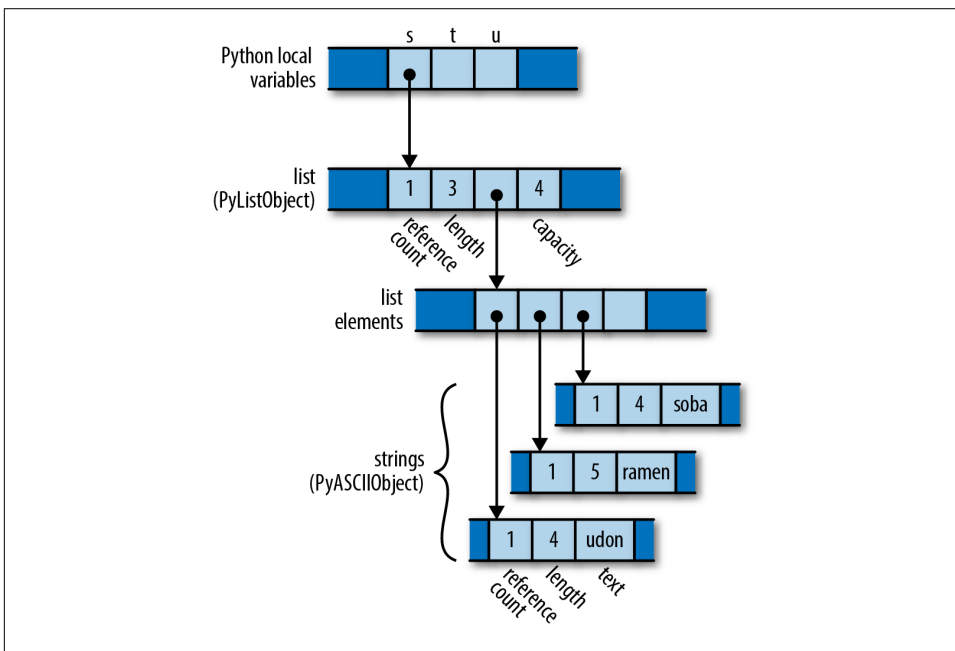

Figure 4-5. How Python represents a list of strings in memory

Since only `s` is pointing to the list, the list's reference count is 1; and since the list is the only object pointing to the strings, each of their reference counts is also 1.

What happens when the program executes the assignments to `t` and `u`? Python implements assignment simply by making the destination point to the same object as the source, and incrementing the object's reference count. So the final state of the program is something like [Figure 4-6](#).

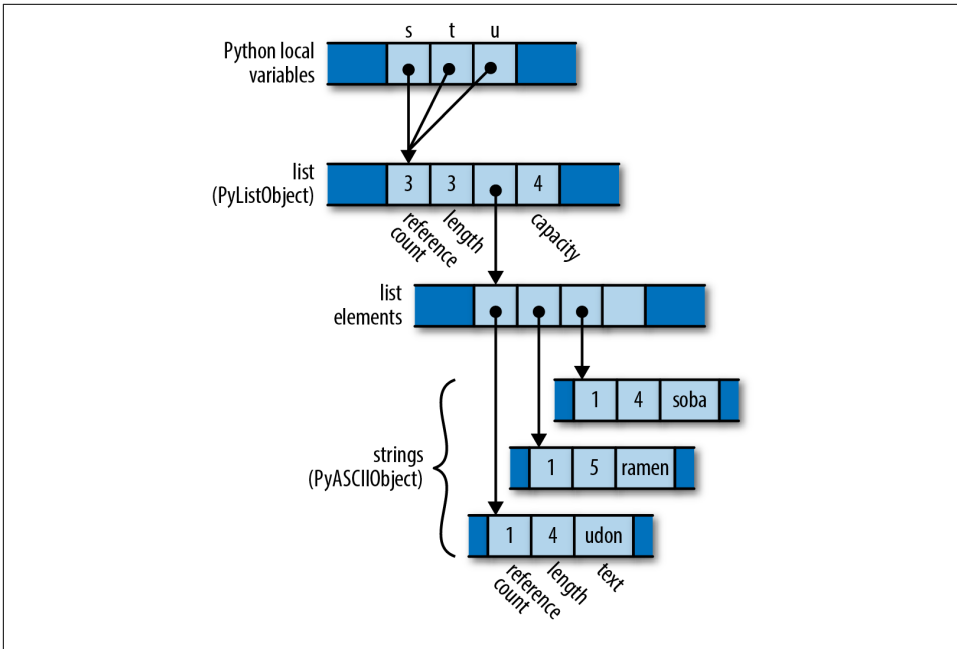

Figure 4-6. The result of assigning `s` to both `t` and `u` in Python

Python has copied the pointer from `s` into `t` and `u`, and updated the list's reference count to 3. Assignment in Python is cheap, but because it creates a new reference to the object, we must maintain reference counts to know when we can free the value.

Now consider the analogous C++ code:

```
using namespace std;
vector<string> s = { "udon", "ramen", "soba" };
vector<string> t = s;
vector<string> u = s;
```

The original value of `s` looks like [Figure 4-7](#) in memory.

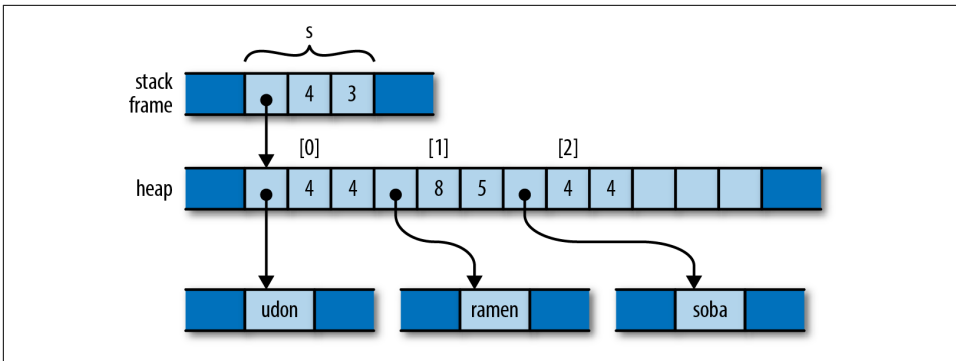

Figure 4-7. How C++ represents a vector of strings in memory

What happens when the program assigns `s` to `t` and `u`? Assigning a `std::vector` produces a copy of the vector in C++; `std::string` behaves similarly. So by the time the program reaches the end of this code, it has actually allocated three vectors and nine strings (Figure 4-8).

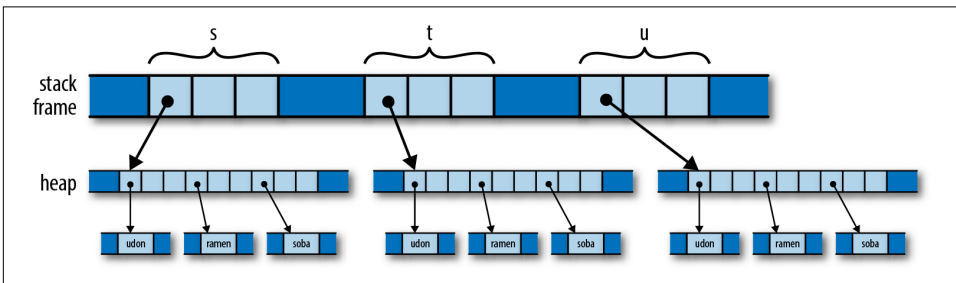

Figure 4-8. The result of assigning `s` to both `t` and `u` in C++

Depending on the values involved, assignment in C++ can consume unbounded amounts of memory and processor time. The advantage, however, is that it's easy for the program to decide when to free all this memory: when the variables go out of scope, everything allocated here gets cleaned up automatically.

In a sense, C++ and Python have chosen opposite trade-offs: Python makes assignment cheap, at the expense of requiring reference counting (and in the general case, garbage collection). C++ keeps the ownership of all the memory clear, at the expense of making assignment carry out a deep copy of the object. C++ programmers are often less than enthusiastic about this choice: deep copies can be expensive, and there are usually more practical alternatives.

So what would the analogous program do in Rust? Here's the code:

```

let s = vec!["udon".to_string(), "ramen".to_string(), "soba".to_string()];
let t = s;
let u = s;

```

Like C and C++, Rust puts plain string literals like "udon" in read-only memory, so for a clearer comparison with the C++ and Python examples, we call `to_string` here to get heap-allocated `String` values.

After carrying out the initialization of `s`, since Rust and C++ use similar representations for vectors and strings, the situation looks just as it did in C++ (Figure 4-9).

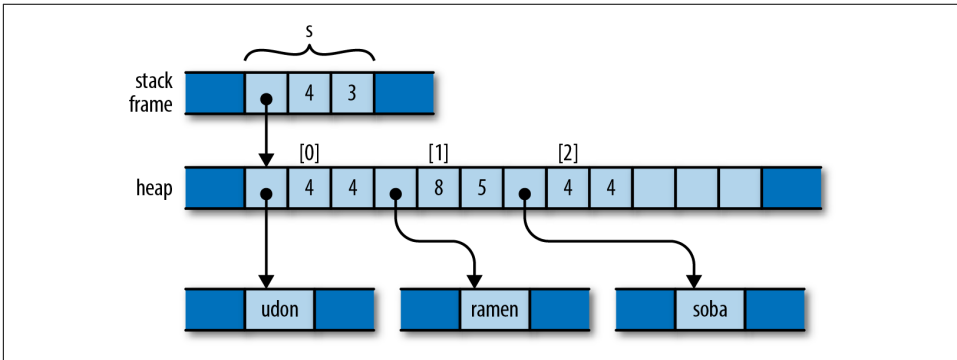

Figure 4-9. How Rust represents a vector of strings in memory

But recall that, in Rust, assignments of most types *move* the value from the source to the destination, leaving the source uninitialized. So after initializing `t`, the program's memory looks like Figure 4-10.

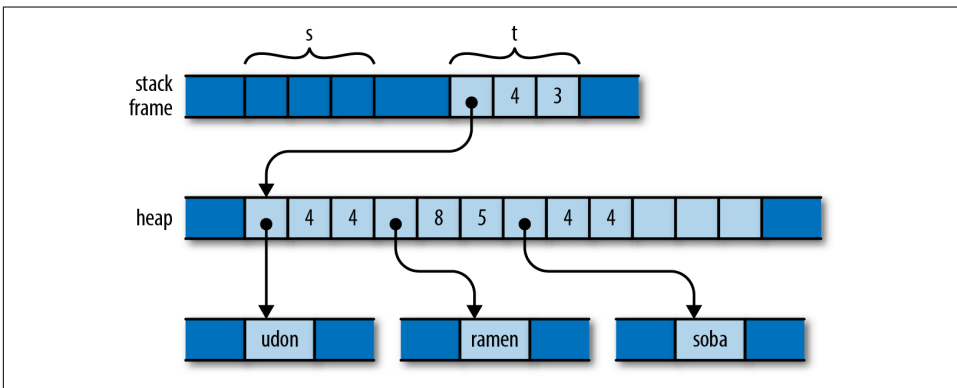

Figure 4-10. The result of assigning `s` to `t` in Rust

What has happened here? The initialization `let t = s;` moved the vector's three header fields from `s` to `t`; now `t` owns the vector. The vector's elements stayed just where they were, and nothing happened to the strings either. Every value still has a

single owner, although one has changed hands. There were no reference counts to be adjusted. And the compiler now considers `s` uninitialized.

So what happens when we reach the initialization `let u = s;`? This would assign the uninitialized value `s` to `u`. Rust prudently prohibits using uninitialized values, so the compiler rejects this code with the following error:

```
error[E0382]: use of moved value: `s`
  --> ownership_double_move.rs:9:9
   |
8  |     let t = s;
   |           - value moved here
9  |     let u = s;
   |           ^ value used here after move
   |
```

Consider the consequences of Rust's use of a move here. Like Python, the assignment is cheap: the program simply moves the three-word header of the vector from one spot to another. But like C++, ownership is always clear: the program doesn't need reference counting or garbage collection to know when to free the vector elements and string contents.

The price you pay is that you must explicitly ask for copies when you want them. If you want to end up in the same state as the C++ program, with each variable holding an independent copy of the structure, you must call the vector's `clone` method, which performs a deep copy of the vector and its elements:

```
let s = vec!["udon".to_string(), "ramen".to_string(), "soba".to_string()];
let t = s.clone();
let u = s.clone();
```

You could also re-create Python's behavior by using Rust's reference-counted pointer types; we'll discuss those shortly in ["Rc and Arc: Shared Ownership" on page 90](#).

## More Operations That Move

In the examples thus far, we've shown initializations, providing values for variables as they come into scope in a `let` statement. Assigning to a variable is slightly different, in that if you move a value into a variable that was already initialized, Rust drops the variable's prior value. For example:

```
let mut s = "Govinda".to_string();
s = "Siddhartha".to_string(); // value "Govinda" dropped here
```

In this code, when the program assigns the string "Siddhartha" to `s`, its prior value "Govinda" gets dropped first. But consider the following:

```
let mut s = "Govinda".to_string();
let t = s;
s = "Siddhartha".to_string(); // nothing is dropped here
```



This time, `t` has taken ownership of the original string from `s`, so that by the time we assign to `s`, it is uninitialized. In this scenario, no string is dropped.

We've used initializations and assignments in the examples here because they're simple, but Rust applies move semantics to almost any use of a value. Passing arguments to functions moves ownership to the function's parameters; returning a value from a function moves ownership to the caller. Building a tuple moves the values into the tuple. And so on.

You may now have a better insight into what's really going on in the examples we offered in the previous section. For example, when we were constructing our vector of composers, we wrote:

```
struct Person { name: String, birth: i32 }

let mut composers = Vec::new();
composers.push(Person { name: "Palestrina".to_string(),
                       birth: 1525 });
```

This code shows several places at which moves occur, beyond initialization and assignment:

#### *Returning values from a function*

The call `Vec::new()` constructs a new vector, and returns, not a pointer to the vector, but the vector itself: its ownership moves from `Vec::new` to the variable `composers`. Similarly, the `to_string` call returns a fresh `String` instance.

#### *Constructing new values*

The `name` field of the new `Person` structure is initialized with the return value of `to_string`. The structure takes ownership of the string.

#### *Passing values to a function*

The entire `Person` structure, not just a pointer, is passed to the vector's `push` method, which moves it onto the end of the structure. The vector takes ownership of the `Person`, and thus becomes the indirect owner of the `name` `String` as well.

Moving values around like this may sound inefficient, but there are two things to keep in mind. First, the moves always apply to the value proper, not the heap storage they own. For vectors and strings, the *value proper* is the three-word header alone; the potentially large element arrays and text buffers sit where they are in the heap. Second, the Rust compiler's code generation is good at "seeing through" all these moves; in practice, the machine code often stores the value directly where it belongs.

## Moves and Control Flow

The previous examples all have very simple control flow; how do moves interact with more complicated code? The general principle is that, if it's possible for a variable to have had its value moved away, and it hasn't definitely been given a new value since, it's considered uninitialized. For example, if a variable still has a value after evaluating an `if` expression's condition, then we can use it in both branches:

```
let x = vec![10, 20, 30];
if c {
    f(x); // ... ok to move from x here
} else {
    g(x); // ... and ok to also move from x here
}
h(x) // bad: x is uninitialized here if either path uses it
```

For similar reasons, moving from a variable in a loop is forbidden:

```
let x = vec![10, 20, 30];
while f() {
    g(x); // bad: x would be moved in first iteration,
          // uninitialized in second
}
```

That is, unless we've definitely given it a new value by the next iteration:

```
let mut x = vec![10, 20, 30];
while f() {
    g(x);           // move from x
    x = h();        // give x a fresh value
}
e(x);
```

## Moves and Indexed Content

We've mentioned that a move leaves its source uninitialized, as the destination takes ownership of the value. But not every kind of value owner is prepared to become uninitialized. For example, consider the following code:

```
// Build a vector of the strings "101", "102", ... "105"
let mut v = Vec::new();
for i in 101 .. 106 {
    v.push(i.to_string());
}

// Pull out random elements from the vector.
let third = v[2];
let fifth = v[4];
```

For this to work, Rust would somehow need to remember that the third and fifth elements of the vector have become uninitialized, and track that information until the vector is dropped. In the most general case, vectors would need to carry around extra

information with them to indicate which elements are live and which have become uninitialized. That is clearly not the right behavior for a systems programming language; a vector should be nothing but a vector. In fact, Rust rejects the preceding code with the following error:

```
error[E0507]: cannot move out of indexed content
  --> ownership_move_out_of_vector.rs:14:17
   |
14 |     let third = v[2];
   |                   ^^^^
   |                   |
   |                   help: consider using a reference instead `&v[2]`
   |                   cannot move out of indexed content
```

It also makes a similar complaint about the move to `fifth`. In the error message, Rust suggests using a reference, in case you want to access the element without moving it. This is often what you want. But what if you really do want to move an element out of a vector? You need to find a method that does so in a way that respects the limitations of the type. Here are three possibilities:

```
// Build a vector of the strings "101", "102", ... "105"
let mut v = Vec::new();
for i in 101 .. 106 {
    v.push(i.to_string());
}

// 1. Pop a value off the end of the vector:
let fifth = v.pop().unwrap();
assert_eq!(fifth, "105");

// 2. Move a value out of the middle of the vector, and move the last
// element into its spot:
let second = v.swap_remove(1);
assert_eq!(second, "102");

// 3. Swap in another value for the one we're taking out:
let third = std::mem::replace(&mut v[2], "substitute".to_string());
assert_eq!(third, "103");

// Let's see what's left of our vector.
assert_eq!(v, vec!["101", "104", "substitute"]);
```

Each one of these methods moves an element out of the vector, but does so in a way that leaves the vector in a state that is fully populated, if perhaps smaller.

Collection types like `Vec` also generally offer methods to consume all their elements in a loop:

```
let v = vec!["libert  ".to_string(),
             "  galit  ".to_string(),
             "fraternit  ".to_string()];
```

```

for mut s in v {
    s.push('!');
    println!("{}", s);
}

```

When we pass the vector to the loop directly, as in `for ... in v`, this *moves* the vector out of `v`, leaving `v` uninitialized. The `for` loop’s internal machinery takes ownership of the vector, and dissects it into its elements. At each iteration, the loop moves another element to the variable `s`. Since `s` now owns the string, we’re able to modify it in the loop body before printing it. And since the vector itself is no longer visible to the code, nothing can observe it mid-loop in some partially emptied state.

If you do find yourself needing to move a value out of an owner that the compiler can’t track, you might consider changing the owner’s type to something that can dynamically track whether it has a value or not. For example, here’s a variant on the earlier example:

```

struct Person { name: Option<String>, birth: i32 }

let mut composers = Vec::new();
composers.push(Person { name: Some("Palestrina".to_string()),
                       birth: 1525 });

```

You can’t do this:

```
let first_name = composers[0].name;
```

That will just elicit the same “cannot move out of indexed content” error shown earlier. But because you’ve changed the type of the `name` field from `String` to `Option<String>`, that means that `None` is a legitimate value for the field to hold, so this works:

```

let first_name = std::mem::replace(&mut composers[0].name, None);
assert_eq!(first_name, Some("Palestrina".to_string()));
assert_eq!(composers[0].name, None);

```

The `replace` call moves out the value of `composers[0].name`, leaving `None` in its place, and passes ownership of the original value to its caller. In fact, using `Option` this way is common enough that the type provides a `take` method for this very purpose. You could write the preceding manipulation more legibly as follows:

```
let first_name = composers[0].name.take();
```

This call to `take` has the same effect as the earlier call to `replace`.

## Copy Types: The Exception to Moves

The examples we’ve shown so far of values being moved involve vectors, strings, and other types that could potentially use a lot of memory and be expensive to copy.

Moves keep ownership of such types clear and assignment cheap. But for simpler types like integers or characters, this sort of careful handling really isn't necessary.

Compare what happens in memory when we assign a `String` with what happens when we assign an `i32` value:

```
let str1 = "somnambulance".to_string();
let str2 = str1;

let num1: i32 = 36;
let num2 = num1;
```

After running this code, memory looks like [Figure 4-11](#).

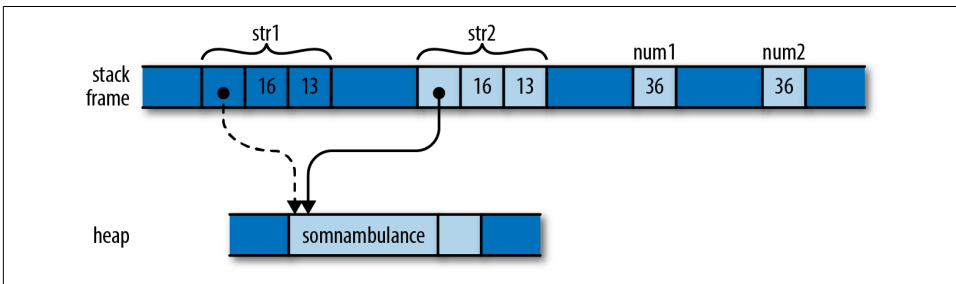

Figure 4-11. Assigning a string moves the value, whereas assigning an `i32` copies it

As with the vectors earlier, assignment *moves* `str1` to `str2`, so that we don't end up with two strings responsible for freeing the same buffer. However, the situation with `num1` and `num2` is different. An `i32` is simply a pattern of bits in memory; it doesn't own any heap resources, or really depend on anything other than the bytes it comprises. By the time we've moved its bits to `num2`, we've made a completely independent copy of `num1`.

Moving a value leaves the source of the move uninitialized. But whereas it serves an essential purpose to treat `str1` as valueless, treating `num1` that way is pointless; no harm could result from continuing to use it. The advantages of a move don't apply here, and it's inconvenient.

Earlier we were careful to say that *most* types are moved; now we've come to the exceptions, the types Rust designates as *Copy types*. Assigning a value of a *Copy type* copies the value, rather than moving it. The source of the assignment remains initialized and usable, with the same value it had before. Passing *Copy types* to functions and constructors behaves similarly.

The standard *Copy types* include all the machine integer and floating-point numeric types, the `char` and `bool` types, and a few others. A tuple or fixed-size array of *Copy types* is itself a *Copy type*.

Only types for which a simple bit-for-bit copy suffices can be Copy. As we've already explained, String is not a Copy type, because it owns a heap-allocated buffer. For similar reasons, Box<T> is not Copy; it owns its heap-allocated referent. The File type, representing an operating system file handle, is not Copy; duplicating such a value would entail asking the operating system for another file handle. Similarly, the MutexGuard type, representing a locked mutex, isn't Copy: this type isn't meaningful to copy at all, as only one thread may hold a mutex at a time.

As a rule of thumb, any type that needs to do something special when a value is dropped cannot be Copy. A Vec needs to free its elements; a File needs to close its file handle; a MutexGuard needs to unlock its mutex. Bit-for-bit duplication of such types would leave it unclear which value was now responsible for the original's resources.

What about types you define yourself? By default, struct and enum types are not Copy:

```
struct Label { number: u32 }

fn print(l: Label) { println!("STAMP: {}", l.number); }

let l = Label { number: 3 };
print(l);
println!("My label number is: {}", l.number);
```

This won't compile; Rust complains:

```
error[E0382]: use of moved value: `l.number`
  --> ownership_struct.rs:12:40
   |
11 |     print(l);
   |         - value moved here
12 |     println!("My label number is: {}", l.number);
   |                                         ^^^^^^^^^ value used here after move
   |
   = note: move occurs because `l` has type `main::Label`, which does not
           implement the `Copy` trait
```

Since Label is not Copy, passing it to print moved ownership of the value to the print function, which then dropped it before returning. But this is silly; a Label is nothing but an i32 with pretensions. There's no reason passing l to print should move the value.

But user-defined types being non-Copy is only the default. If all the fields of your struct are themselves Copy, then you can make the type Copy as well by placing the attribute #[derive(Copy, Clone)] above the definition, like so:

```
#[derive(Copy, Clone)]
struct Label { number: u32 }
```

With this change, the preceding code compiles without complaint. However, if we try this on a type whose fields are not all Copy, it doesn't work. Compiling the following code:

```
#[derive(Copy, Clone)]
struct StringLabel { name: String }
```

elicits this error:

```
error[E0204]: the trait `Copy` may not be implemented for this type
--> ownership_string_label.rs:7:10
   |
 7 | #[derive(Copy, Clone)]
   |          ^^^^
 8 | struct StringLabel { name: String }
   |                      ----- this field does not implement `Copy`
```

Why aren't user-defined types automatically Copy, assuming they're eligible? Whether a type is Copy or not has a big effect on how code is allowed to use it: Copy types are more flexible, since assignment and related operations don't leave the original uninitialized. But for a type's implementer, the opposite is true: Copy types are very limited in which types they can contain, whereas non-Copy types can use heap allocation and own other sorts of resources. So making a type Copy represents a serious commitment on the part of the implementer: if it's necessary to change it to non-Copy later, much of the code that uses it will probably need to be adapted.

While C++ lets you overload assignment operators and define specialized copy and move constructors, Rust doesn't permit this sort of customization. In Rust, every move is a byte-for-byte, shallow copy that leaves the source uninitialized. Copies are the same, except that the source remains initialized. This does mean that C++ classes can provide convenient interfaces that Rust types cannot, where ordinary-looking code implicitly adjusts reference counts, puts off expensive copies for later, or uses other sophisticated implementation tricks.

But the effect of this flexibility on C++ as a language is to make basic operations like assignment, passing parameters, and returning values from functions less predictable. For example, earlier in this chapter we showed how assigning one variable to another in C++ can require arbitrary amounts of memory and processor time. One of Rust's principles is that costs should be apparent to the programmer. Basic operations must remain simple. Potentially expensive operations should be explicit, like the calls to `clone` in the earlier example that make deep copies of vectors and the strings they contain.

In this section, we've talked about Copy and Clone in vague terms as characteristics a type might have. They are actually examples of *traits*, Rust's open-ended facility for categorizing types based on what you can do with them. We describe traits in general in [Chapter 11](#), and Copy and Clone in particular in [Chapter 13](#).

## Rc and Arc: Shared Ownership

Although most values have unique owners in typical Rust code, in some cases it's difficult to find every value a single owner that has the lifetime you need; you'd like the value to simply live until everyone's done using it. For these cases, Rust provides the reference-counted pointer types `Rc` and `Arc`. As you would expect from Rust, these are entirely safe to use: you cannot forget to adjust the reference count, or create other pointers to the referent that Rust doesn't notice, or stumble over any of the other sorts of problems that accompany reference-counted pointer types in C++.

The `Rc` and `Arc` types are very similar; the only difference between them is that an `Arc` is safe to share between threads directly—the name `Arc` is short for *atomic reference count*—whereas a plain `Rc` uses faster non-thread-safe code to update its reference count. If you don't need to share the pointers between threads, there's no reason to pay the performance penalty of an `Arc`, so you should use `Rc`; Rust will prevent you from accidentally passing one across a thread boundary. The two types are otherwise equivalent, so for the rest of this section, we'll only talk about `Rc`.

Earlier in the chapter we showed how Python uses reference counts to manage its values' lifetimes. You can use `Rc` to get a similar effect in Rust. Consider the following code:

```
use std::rc::Rc;

// Rust can infer all these types; written out for clarity
let s: Rc<String> = Rc::new("shirataki".to_string());
let t: Rc<String> = s.clone();
let u: Rc<String> = s.clone();
```

For any type `T`, an `Rc<T>` value is a pointer to a heap-allocated `T` that has had a reference count affixed to it. Cloning an `Rc<T>` value does not copy the `T`; instead, it simply creates another pointer to it, and increments the reference count. So the preceding code produces the situation illustrated in [Figure 4-12](#) in memory.

Each of the three `Rc<String>` pointers is referring to the same block of memory, which holds a reference count and space for the `String`. The usual ownership rules apply to the `Rc` pointers themselves, and when the last extant `Rc` is dropped, Rust drops the `String` as well.



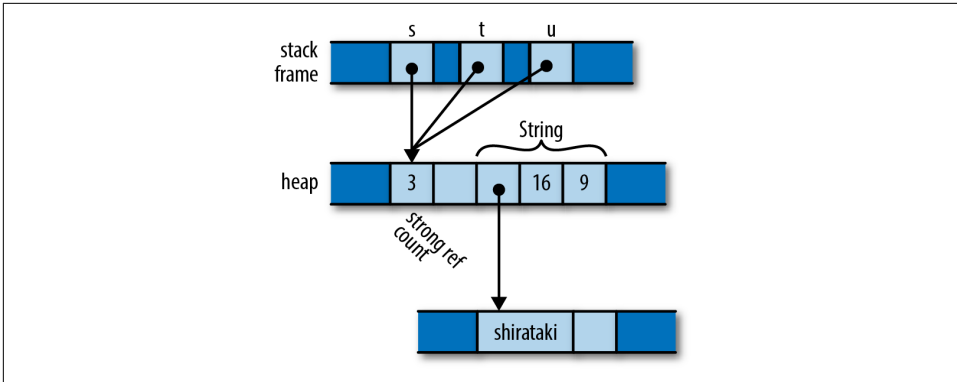

Figure 4-12. A reference-counted string, with three references

You can use any of `String`'s usual methods directly on an `Rc<String>`:

```
assert!(s.contains("shira"));
assert_eq!(t.find("taki"), Some(5));
println!("{}", u);
```

A value owned by an `Rc` pointer is immutable. If you try to add some text to the end of the string:

```
s.push_str(" noodles");
```

Rust will decline:

```
error: cannot borrow immutable borrowed content as mutable
--> ownership_rc_mutability.rs:12:5
|
12 |     s.push_str(" noodles");
|       ^ cannot borrow as mutable
```

Rust's memory and thread-safety guarantees depend on ensuring that no value is ever simultaneously shared and mutable. Rust assumes the referent of an `Rc` pointer might in general be shared, so it must not be mutable. We explain why this restriction is important in [Chapter 5](#).

One well-known problem with using reference counts to manage memory is that, if there are ever two reference-counted values that point to each other, each will hold the other's reference count above zero, so the values will never be freed ([Figure 4-13](#)).

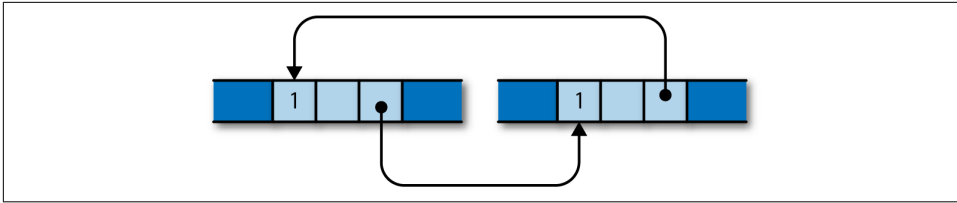

Figure 4-13. A reference-counting loop; these objects will not be freed

It is possible to leak values in Rust this way, but such situations are rare. You cannot create a cycle without, at some point, making an older value point to a newer value. This obviously requires the older value to be mutable. Since `Rc` pointers hold their referents immutable, it's not normally possible to create a cycle. However, Rust does provide ways to create mutable portions of otherwise immutable values; this is called *interior mutability*, and we cover it in “[Interior Mutability](#)” on page 205. If you combine those techniques with `Rc` pointers, you can create a cycle and leak memory.

You can sometimes avoid creating cycles of `Rc` pointers by using *weak pointers*, `std::rc::Weak`, for some of the links instead. However, we won't cover those in this book; see the standard library's documentation for details.

Moves and reference-counted pointers are two ways to relax the rigidity of the ownership tree. In the next chapter, we'll look at a third way: borrowing references to values. Once you have become comfortable with both ownership and borrowing, you will have climbed the steepest part of Rust's learning curve, and you'll be ready to take advantage of Rust's unique strengths.

---

# References

*Libraries cannot provide new inabilities.*

—Mark Miller

All the pointer types we’ve seen so far—the simple `Box<T>` heap pointer, and the pointers internal to `String` and `Vec` values—are owning pointers: when the owner is dropped, the referent goes with it. Rust also has nonowning pointer types called *references*, which have no effect on their referents’ lifetimes.

In fact, it’s rather the opposite: references must never outlive their referents. You must make it apparent in your code that no reference can possibly outlive the value it points to. To emphasize this, Rust refers to creating a reference to some value as *borrowing* the value: what you have borrowed, you must eventually return to its owner.

If you felt a moment of skepticism when reading the phrase “You must make it apparent in your code,” you’re in excellent company. The references themselves are nothing special—under the hood, they’re just addresses. But the rules that keep them safe are novel to Rust; outside of research languages, you won’t have seen anything like them before. And although these rules are the part of Rust that requires the most effort to master, the breadth of classic, absolutely everyday bugs they prevent is surprising, and their effect on multithreaded programming is liberating. This is Rust’s radical wager, again.

As an example, let’s suppose we’re going to build a table of murderous Renaissance artists and the works they’re known for. Rust’s standard library includes a hash table type, so we can define our type like this:

```
use std::collections::HashMap;

type Table = HashMap<String, Vec<String>>;
```

In other words, this is a hash table that maps `String` values to `Vec<String>` values, taking the name of an artist to a list of the names of their works. You can iterate over the entries of a `HashMap` with a `for` loop, so we can write a function to print out a `Table` for debugging:

```
fn show(table: Table) {
    for (artist, works) in table {
        println!("works by {}:", artist);
        for work in works {
            println!("  {}", work);
        }
    }
}
```

Constructing and printing the table is straightforward:

```
fn main() {
    let mut table = Table::new();
    table.insert("Gesualdo".to_string(),
                vec!["many madrigals".to_string(),
                    "Tenebrae Responsoria".to_string()]);
    table.insert("Caravaggio".to_string(),
                vec!["The Musicians".to_string(),
                    "The Calling of St. Matthew".to_string()]);
    table.insert("Cellini".to_string(),
                vec!["Perseus with the head of Medusa".to_string(),
                    "a salt cellar".to_string()]);

    show(table);
}
```

And it all works fine:

```
$ cargo run
  Running `/home/jimb/rust/book/fragments/target/debug/fragments`
works by Gesualdo:
  Tenebrae Responsoria
  many madrigals
works by Cellini:
  Perseus with the head of Medusa
  a salt cellar
works by Caravaggio:
  The Musicians
  The Calling of St. Matthew
$
```

But if you've read the previous chapter's section on moves, this definition for `show` should raise a few questions. In particular, `HashMap` is not `Copy`—it can't be, since it owns a dynamically allocated table. So when the program calls `show(table)`, the whole structure gets moved to the function, leaving the variable `table` uninitialized. If the calling code tries to use `table` now, it'll run into trouble:

```

...
show(table);
assert_eq!(table["Gesualdo"][0], "many madrigals");

```

Rust complains that `table` isn't available anymore:

```

error[E0382]: use of moved value: `table`
--> references_show_moves_table.rs:29:16
   |
28 |     show(table);
   |         ----- value moved here
29 |     assert_eq!(table["Gesualdo"][0], "many madrigals");
   |                   ^^^^^ value used here after move
   |
   = note: move occurs because `table` has type `HashMap<String, Vec<String>>`,
           which does not implement the `Copy` trait

```

In fact, if we look into the definition of `show`, the outer `for` loop takes ownership of the hash table and consumes it entirely; and the inner `for` loop does the same to each of the vectors. (We saw this behavior earlier, in the “liberté, égalité, fraternité” example.) Because of move semantics, we’ve completely destroyed the entire structure simply by trying to print it out. Thanks, Rust!

The right way to handle this is to use references. A reference lets you access a value without affecting its ownership. References come in two kinds:

- A *shared reference* lets you read but not modify its referent. However, you can have as many shared references to a particular value at a time as you like. The expression `&e` yields a shared reference to `e`'s value; if `e` has the type `T`, then `&e` has the type `&T`, pronounced “ref T”. Shared references are `Copy`.
- If you have a *mutable reference* to a value, you may both read and modify the value. However, you may not have any other references of any sort to that value active at the same time. The expression `&mut e` yields a mutable reference to `e`'s value; you write its type as `&mut T`, which is pronounced “ref mute T”. Mutable references are not `Copy`.

You can think of the distinction between shared and mutable references as a way to enforce a *multiple readers or single writer* rule at compile time. In fact, this rule doesn't apply only to references; it covers the borrowed value's owner as well. As long as there are shared references to a value, not even its owner can modify it; the value is locked down. Nobody can modify `table` while `show` is working with it. Similarly, if there is a mutable reference to a value, it has exclusive access to the value; you can't use the owner at all, until the mutable reference goes away. Keeping sharing and mutation fully separate turns out to be essential to memory safety, for reasons we'll go into later in the chapter.

The printing function in our example doesn't need to modify the table, just read its contents. So the caller should be able to pass it a shared reference to the table, as follows:

```
show(&table);
```

References are nonowning pointers, so the `table` variable remains the owner of the entire structure; `show` has just borrowed it for a bit. Naturally, we'll need to adjust the definition of `show` to match, but you'll have to look closely to see the difference:

```
fn show(table: &Table) {
    for (artist, works) in table {
        println!("works by {}:", artist);
        for work in works {
            println!("  {}", work);
        }
    }
}
```

The type of `show`'s parameter `table` has changed from `Table` to `&Table`: instead of passing the table by value (and hence moving ownership into the function), we're now passing a shared reference. That's the only textual change. But how does this play out as we work through the body?

Whereas our original outer `for` loop took ownership of the `HashMap` and consumed it, in our new version it receives a shared reference to the `HashMap`. Iterating over a shared reference to a `HashMap` is defined to produce shared references to each entry's key and value: `artist` has changed from a `String` to a `&String`, and `works` from a `Vec<String>` to a `&Vec<String>`.

The inner loop is changed similarly. Iterating over a shared reference to a vector is defined to produce shared references to its elements, so `work` is now a `&String`. No ownership changes hands anywhere in this function; it's just passing around nonowning references.

Now, if we wanted to write a function to alphabetize the works of each artist, a shared reference doesn't suffice, since shared references don't permit modification. Instead, the sorting function needs to take a mutable reference to the table:

```
fn sort_works(table: &mut Table) {
    for (_artist, works) in table {
        works.sort();
    }
}
```

And we need to pass it one:

```
sort_works(&mut table);
```

This mutable borrow grants `sort_works` the ability to read and modify our structure, as required by the vectors' `sort` method.

When we pass a value to a function in a way that moves ownership of the value to the function, we say that we have passed it *by value*. If we instead pass the function a reference to the value, we say that we have passed the value *by reference*. For example, we fixed our `show` function by changing it to accept the table by reference, rather than by value. Many languages draw this distinction, but it's especially important in Rust, because it spells out how ownership is affected.

## References as Values

The preceding example shows a pretty typical use for references: allowing functions to access or manipulate a structure without taking ownership. But references are more flexible than that, so let's look at some examples to get a more detailed view of what's going on.

### Rust References Versus C++ References

If you're familiar with references in C++, they do have something in common with Rust references. Most importantly, they're both just addresses at the machine level. But in practice, Rust's references have a very different feel.

In C++, references are created implicitly by conversion, and dereferenced implicitly too:

```
// C++ code!  
int x = 10;  
int &r = x;           // initialization creates reference implicitly  
assert(r == 10);    // implicitly dereference r to see x's value  
r = 20;             // stores 20 in x, r itself still points to x
```

In Rust, references are created explicitly with the `&` operator, and dereferenced explicitly with the `*` operator:

```
// Back to Rust code from this point onward.  
let x = 10;  
let r = &x;          // &x is a shared reference to x  
assert!(*r == 10);  // explicitly dereference r
```

To create a mutable reference, use the `&mut` operator:

```
let mut y = 32;  
let m = &mut y;     // &mut y is a mutable reference to y  
*m += 32;           // explicitly dereference m to set y's value  
assert!(*m == 64); // and to see y's new value
```

But you might recall that, when we fixed the `show` function to take the table of artists by reference instead of by value, we never had to use the `*` operator. Why is that?

Since references are so widely used in Rust, the `.` operator implicitly dereferences its left operand, if needed:

```
struct Anime { name: &'static str, bechdel_pass: bool };
let aria = Anime { name: "Aria: The Animation", bechdel_pass: true };
let anime_ref = &aria;
assert_eq!(anime_ref.name, "Aria: The Animation");

// Equivalent to the above, but with the dereference written out:
assert_eq!((*anime_ref).name, "Aria: The Animation");
```

The `println!` macro used in the `show` function expands to code that uses the `.` operator, so it takes advantage of this implicit dereference as well.

The `.` operator can also implicitly borrow a reference to its left operand, if needed for a method call. For example, `Vec`'s `sort` method takes a mutable reference to the vector, so the two calls shown here are equivalent:

```
let mut v = vec![1973, 1968];
v.sort(); // implicitly borrows a mutable reference to v
(&mut v).sort(); // equivalent; much uglier
```

In a nutshell, whereas C++ converts implicitly between references and lvalues (that is, expressions referring to locations in memory), with these conversions appearing anywhere they're needed, in Rust you use the `&` and `*` operators to create and follow references, with the exception of the `.` operator, which borrows and dereferences implicitly.

## Assigning References

Assigning to a Rust reference makes it point at a new value:

```
let x = 10;
let y = 20;
let mut r = &x;

if b { r = &y; }

assert!(*r == 10 || *r == 20);
```

The reference `r` initially points to `x`. But if `b` is true, the code points it at `y` instead, as illustrated in [Figure 5-1](#).

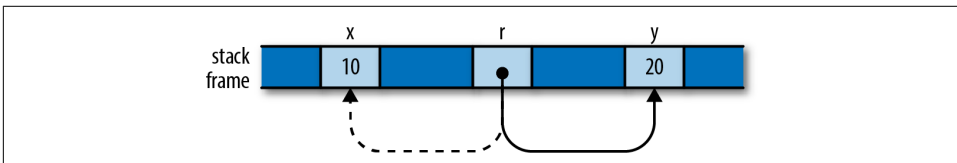

Figure 5-1. The reference `r`, now pointing to `y` instead of `x`



This is very different from C++, where assigning to a reference stores the value in its referent. There's no way to point a C++ reference to a location other than the one it was initialized with.

## References to References

Rust permits references to references:

```
struct Point { x: i32, y: i32 }  
let point = Point { x: 1000, y: 729 };  
let r: &Point = &point;  
let rr: &&Point = &r;  
let rrr: &&&Point = &rr;
```

(We've written out the reference types for clarity, but you could omit them; there's nothing here Rust can't infer for itself.) The `.` operator follows as many references as it takes to find its target:

```
assert_eq!(rrr.y, 729);
```

In memory, the references are arranged as shown in [Figure 5-2](#).

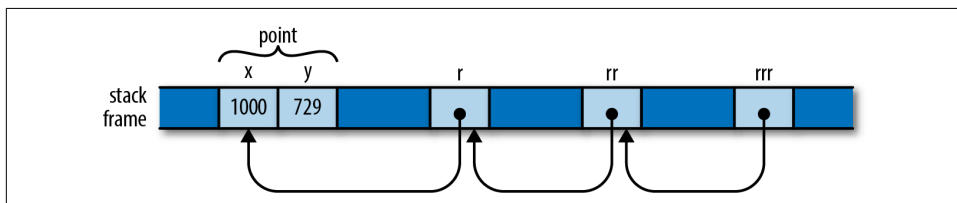

Figure 5-2. A chain of references to references

So the expression `rrr.y`, guided by the type of `rrr`, actually traverses three references to get to the `Point` before fetching its `y` field.

## Comparing References

Like the `.` operator, Rust's comparison operators “see through” any number of references, as long as both operands have the same type:

```
let x = 10;  
let y = 10;  
  
let rx = &x;  
let ry = &y;  
  
let rrx = &rx;  
let rry = &ry;  
  
assert!(rrx <= rry);  
assert!(rrx == rry);
```

The final assertion here succeeds, even though `rx` and `ry` point at different values (namely, `x` and `y`), because the `==` operator follows all the references and performs the comparison on their final targets, `x` and `y`. This is almost always the behavior you want, especially when writing generic functions. If you actually want to know whether two references point to the same memory, you can use `std::ptr::eq`, which compares them as addresses:

```
assert!(rx == ry); // their referents are equal
assert!(!std::ptr::eq(rx, ry)); // but occupy different addresses
```

## References Are Never Null

Rust references are never null. There's no analogue to C's `NULL` or C++'s `nullptr`; there is no default initial value for a reference (you can't use any variable until it's been initialized, regardless of its type); and Rust won't convert integers to references (outside of `unsafe` code), so you can't convert zero into a reference.

C and C++ code often uses a null pointer to indicate the absence of a value: for example, the `malloc` function either returns a pointer to a new block of memory, or `nullptr` if there isn't enough memory available to satisfy the request. In Rust, if you need a value that is either a reference to something or not, use the type `Option<T>`. At the machine level, Rust represents `None` as a null pointer, and `Some(r)`, where `r` is a `&T` value, as the nonzero address, so `Option<T>` is just as efficient as a nullable pointer in C or C++, even though it's safer: its type requires you to check whether it's `None` before you can use it.

## Borrowing References to Arbitrary Expressions

Whereas C and C++ only let you apply the `&` operator to certain kinds of expressions, Rust lets you borrow a reference to the value of any sort of expression at all:

```
fn factorial(n: usize) -> usize {
    (1..n+1).fold(1, |a, b| a * b)
}
let r = &factorial(6);
assert_eq!(r + &1009, 1729);
```

In situations like this, Rust simply creates an anonymous variable to hold the expression's value, and makes the reference point to that. The lifetime of this anonymous variable depends on what you do with the reference:

- If you immediately assign the reference to a variable in a `let` statement (or make it part of some struct or array that is being immediately assigned), then Rust makes the anonymous variable live as long as the variable the `let` initializes. In the preceding example, Rust would do this for the referent of `r`.

- Otherwise, the anonymous variable lives to the end of the enclosing statement. In our example, the anonymous variable created to hold 1009 lasts only to the end of the `assert_eq!` statement.

If you're used to C or C++, this may sound error-prone. But remember that Rust will never let you write code that would produce a dangling reference. If the reference could ever be used beyond the anonymous variable's lifetime, Rust will always report the problem to you at compile time. You can then fix your code to keep the referent in a named variable with an appropriate lifetime.

## References to Slices and Trait Objects

The references we've shown so far are all simple addresses. However, Rust also includes two kinds of *fat pointers*, two-word values carrying the address of some value, along with some further information necessary to put the value to use.

A reference to a slice is a fat pointer, carrying the starting address of the slice and its length. We described slices in detail in [Chapter 3](#).

Rust's other kind of fat pointer is a *trait object*, a reference to a value that implements a certain trait. A trait object carries a value's address and a pointer to the trait's implementation appropriate to that value, for invoking the trait's methods. We'll cover trait objects in detail in ["Trait Objects" on page 238](#).

Aside from carrying this extra data, slice and trait object references behave just like the other sorts of references we've shown so far in this chapter: they don't own their referents; they are not allowed to outlive their referents; they may be mutable or shared; and so on.

## Reference Safety

As we've presented them so far, references look pretty much like ordinary pointers in C or C++. But those are unsafe; how does Rust keep its references under control? Perhaps the best way to see the rules in action is to try to break them. We'll start with the simplest example possible, and then add in interesting complications and explain how they work out.

## Borrowing a Local Variable

Here's a pretty obvious case. You can't borrow a reference to a local variable and take it out of the variable's scope:

```
{
    let r;
    {
        let x = 1;
    }
}
```

```

    r = &x;
}
assert_eq!(*r, 1); // bad: reads memory `x` used to occupy
}

```

The Rust compiler rejects this program, with a detailed error message:

```

error: `x` does not live long enough
--> references_dangling.rs:8:5
|
7 |         r = &x;
|           - borrow occurs here
8 |     }
|       ^ `x` dropped here while still borrowed
9 |     assert_eq!(*r, 1); // bad: reads memory `x` used to occupy
10 | }
|   - borrowed value needs to live until here

```

Rust’s complaint is that `x` lives only until the end of the inner block, whereas the reference remains alive until the end of the outer block, making it a dangling pointer, which is verboten.

While it’s obvious to a human reader that this program is broken, it’s worth looking at how Rust itself reached that conclusion. Even this simple example shows the logical tools Rust uses to check much more complex code.

Rust tries to assign each reference type in your program a *lifetime* that meets the constraints imposed by how it is used. A lifetime is some stretch of your program for which a reference could be safe to use: a lexical block, a statement, an expression, the scope of some variable, or the like. Lifetimes are entirely figments of Rust’s compile-time imagination. At runtime, a reference is nothing but an address; its lifetime is part of its type and has no runtime representation.

In this example, there are three lifetimes whose relationships we need to work out. The variables `r` and `x` each have a lifetime, extending from the point at which they’re initialized until the point that they go out of scope. The third lifetime is that of a reference type: the type of the reference we borrow to `&x`, and store in `r`.

Here’s one constraint that should seem pretty obvious: if you have a variable `x`, then a reference to `x` must not outlive `x` itself, as shown in [Figure 5-3](#).

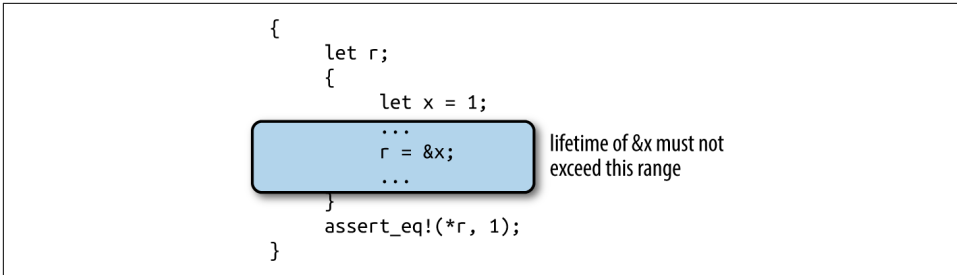

Figure 5-3. Permissible lifetimes for `&x`

Beyond the point where `x` goes out of scope, the reference would be a dangling pointer. We say that the variable's lifetime must *contain* or *enclose* that of the reference borrowed from it.

Here's another kind of constraint: if you store a reference in a variable `r`, the reference's type must be good for the entire lifetime of the variable, from the point it is initialized to the point it goes out of scope, as shown in [Figure 5-4](#).

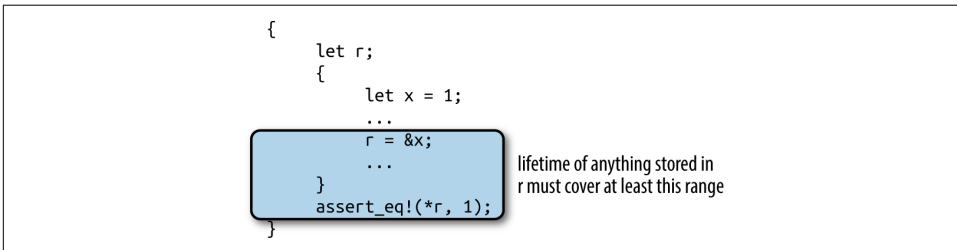

Figure 5-4. Permissible lifetimes for reference stored in `r`

If the reference can't live at least as long as the variable does, then at some point `r` will be a dangling pointer. We say that the reference's lifetime must contain or enclose the variable's.

The first kind of constraint limits how large a reference's lifetime can be, while the second kind limits how small it can be. Rust simply tries to find a lifetime for each reference that satisfies all these constraints. In our example, however, there is no such lifetime, as shown in [Figure 5-5](#).

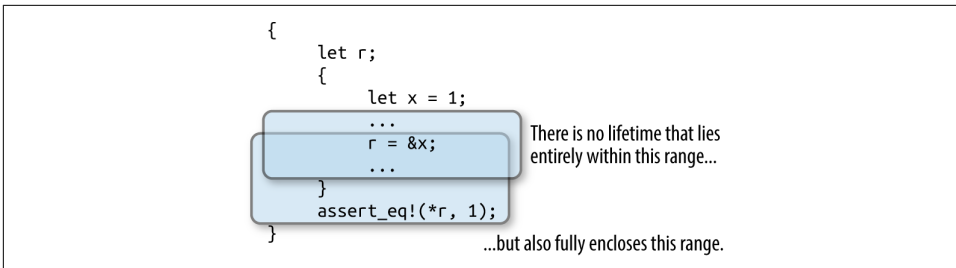

Figure 5-5. A reference with contradictory constraints on its lifetime

Let's now consider a different example where things do work out. We have the same kinds of constraints: the reference's lifetime must be contained by `x`'s, but fully enclose `r`'s. But because `r`'s lifetime is smaller now, there is a lifetime that meets the constraints, as shown in Figure 5-6.

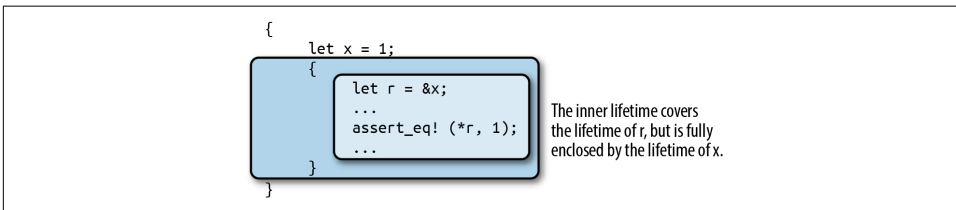

Figure 5-6. A reference with a lifetime enclosing `r`'s scope, but within `x`'s scope

These rules apply in a natural way when you borrow a reference to some part of some larger data structure, like an element of a vector:

```

let v = vec![1, 2, 3];
let r = &v[1];

```

Since `v` owns the vector, which owns its elements, the lifetime of `v` must enclose that of the reference type of `&v[1]`. Similarly, if you store a reference in some data structure, its lifetime must enclose that of the data structure. If you build a vector of references, say, all of them must have lifetimes enclosing that of the variable that owns the vector.

This is the essence of the process Rust uses for all code. Bringing more language features into the picture—data structures and function calls, say—introduces new sorts of constraints, but the principle remains the same: first, understand the constraints arising from the way the program uses references; then, find lifetimes that satisfy them. This is not so different from the process C and C++ programmers impose on themselves; the difference is that Rust knows the rules, and enforces them.

## Receiving References as Parameters

When we pass a reference to a function, how does Rust make sure the function uses it safely? Suppose we have a function `f` that takes a reference and stores it in a global variable. We'll need to make a few revisions to this, but here's a first cut:

```
// This code has several problems, and doesn't compile.  
static mut STASH: &i32;  
fn f(p: &i32) { STASH = p; }
```

Rust's equivalent of a global variable is called a *static*: it's a value that's created when the program starts and lasts until it terminates. (Like any other declaration, Rust's module system controls where statics are visible, so they're only "global" in their lifetime, not their visibility.) We cover statics in [Chapter 8](#), but for now we'll just call out a few rules that the code just shown doesn't follow:

- Every static must be initialized.
- Mutable statics are inherently not thread-safe (after all, any thread can access a static at any time), and even in single-threaded programs, they can fall prey to other sorts of reentrancy problems. For these reasons, you may access a mutable static only within an `unsafe` block. In this example we're not concerned with those particular problems, so we'll just throw in an `unsafe` block and move on.

With those revisions made, we now have the following:

```
static mut STASH: &i32 = &128;  
fn f(p: &i32) { // still not good enough  
    unsafe {  
        STASH = p;  
    }  
}
```

We're almost done. To see the remaining problem, we need to write out a few things that Rust is helpfully letting us omit. The signature of `f` as written here is actually shorthand for the following:

```
fn f<'a>(p: &'a i32) { ... }
```

Here, the lifetime `'a` (pronounced "tick A") is a *lifetime parameter* of `f`. You can read `<'a>` as "for any lifetime `'a`" so when we write `fn f<'a>(p: &'a i32)`, we're defining a function that takes a reference to an `i32` with any given lifetime `'a`.

Since we must allow `'a` to be any lifetime, things had better work out if it's the smallest possible lifetime: one just enclosing the call to `f`. This assignment then becomes a point of contention:

```
STASH = p;
```

Since STASH lives for the program's entire execution, the reference type it holds must have a lifetime of the same length; Rust calls this the *'static lifetime*. But the lifetime of `p`'s reference is some `'a`, which could be anything, as long as it encloses the call to `f`. So, Rust rejects our code:

```
error[E0312]: lifetime of reference outlives lifetime of borrowed content...
--> references_static.rs:6:17
   |
6 |         STASH = p;
   |                   ^
   |
   = note: ...the reference is valid for the static lifetime...
note: ...but the borrowed content is only valid for the anonymous lifetime #1
      defined on the function body at 4:0
--> references_static.rs:4:1
   |
4 | / fn f(p: &i32) { // still not good enough
5 | |     unsafe {
6 | |         STASH = p;
7 | |     }
8 | | }
   | |_^
```

At this point, it's clear that our function can't accept just any reference as an argument. But it ought to be able to accept a reference that has a *'static lifetime*: storing such a reference in STASH can't create a dangling pointer. And indeed, the following code compiles just fine:

```
static mut STASH: &i32 = &10;

fn f(p: &'static i32) {
    unsafe {
        STASH = p;
    }
}
```

This time, `f`'s signature spells out that `p` must be a reference with lifetime *'static*, so there's no longer any problem storing that in STASH. We can only apply `f` to references to other statics, but that's the only thing that's certain not to leave STASH dangling anyway. So we can write:

```
static WORTH_POINTING_AT: i32 = 1000;
f(&WORTH_POINTING_AT);
```

Since `WORTH_POINTING_AT` is a static, the type of `&WORTH_POINTING_AT` is *&'static i32*, which is safe to pass to `f`.

Take a step back, though, and notice what happened to `f`'s signature as we amended our way to correctness: the original `f(p: &i32)` ended up as `f(p: &'static i32)`. In other words, we were unable to write a function that stashed a reference in a global



variable without reflecting that intention in the function's signature. In Rust, a function's signature always exposes the body's behavior.

Conversely, if we do see a function with a signature like `g(p: &i32)` (or with the lifetimes written out, `g<'a>(p: &'a i32)`), we can tell that it *does not* stash its argument `p` anywhere that will outlive the call. There's no need to look into `g`'s definition; the signature alone tells us what `g` can and can't do with its argument. This fact ends up being very useful when you're trying to establish the safety of a call to the function.

## Passing References as Arguments

Now that we've shown how a function's signature relates to its body, let's examine how it relates to the function's callers. Suppose you have the following code:

```
// This could be written more briefly: fn g(p: &i32),
// but let's write out the lifetimes for now.
fn g<'a>(p: &'a i32) { ... }

let x = 10;
g(&x);
```

From `g`'s signature alone, Rust knows it will not save `p` anywhere that might outlive the call: any lifetime that encloses the call must work for `'a`. So Rust chooses the smallest possible lifetime for `&x`: that of the call to `g`. This meets all constraints: it doesn't outlive `x`, and encloses the entire call to `g`. So this code passes muster.

Note that although `g` takes a lifetime parameter `'a`, we didn't need to mention it when calling `g`. You only need to worry about lifetime parameters when defining functions and types; when using them, Rust infers the lifetimes for you.

What if we tried to pass `&x` to our function `f` from earlier that stores its argument in a static?

```
fn f(p: &'static i32) { ... }

let x = 10;
f(&x);
```

This fails to compile: the reference `&x` must not outlive `x`, but by passing it to `f`, we constrain it to live at least as long as `'static`. There's no way to satisfy everyone here, so Rust rejects the code.

## Returning References

It's common for a function to take a reference to some data structure, and then return a reference into some part of that structure. For example, here's a function that returns a reference to the smallest element of a slice:

```

// v should have at least one element.
fn smallest(v: &[i32]) -> &i32 {
    let mut s = &v[0];
    for r in &v[1..] {
        if *r < *s { s = r; }
    }
    s
}

```

We've omitted lifetimes from that function's signature in the usual way. When a function takes a single reference as an argument, and returns a single reference, Rust assumes that the two must have the same lifetime. Writing this out explicitly would give us:

```
fn smallest<'a>(v: &'a [i32]) -> &'a i32 { ... }
```

Suppose we call `smallest` like this:

```

let s;
{
    let parabola = [9, 4, 1, 0, 1, 4, 9];
    s = smallest(&parabola);
}
assert_eq!(*s, 0); // bad: points to element of dropped array

```

From `smallest`'s signature, we can see that its argument and return value must have the same lifetime, 'a. In our call, the argument `&parabola` must not outlive `parabola` itself; yet `smallest`'s return value must live at least as long as `s`. There's no possible lifetime 'a that can satisfy both constraints, so Rust rejects the code:

```

error: `parabola` does not live long enough
--> references_lifetimes_propagated.rs:12:5
   |
11 |         s = smallest(&parabola);
   |                      ----- borrow occurs here
12 |     }
   |     ^ `parabola` dropped here while still borrowed
13 |     assert_eq!(*s, 0); // bad: points to element of dropped array
14 | }
   | - borrowed value needs to live until here

```

Moving `s` so that its lifetime is clearly contained within `parabola`'s fixes the problem:

```

{
    let parabola = [9, 4, 1, 0, 1, 4, 9];
    let s = smallest(&parabola);
    assert_eq!(*s, 0); // fine: parabola still alive
}

```

Lifetimes in function signatures let Rust assess the relationships between the references you pass to the function and those the function returns, and ensure they're being used safely.

## Structs Containing References

How does Rust handle references stored in data structures? Here's the same erroneous program we looked at earlier, except that we've put the reference inside a structure:

```
// This does not compile.
struct S {
    r: &i32
}

let s;
{
    let x = 10;
    s = S { r: &x };
}
assert_eq!(*s.r, 10); // bad: reads from dropped `x`
```

The safety constraints Rust places on references can't magically disappear just because we hid the reference inside a struct. Somehow, those constraints must end up applying to `S` as well. Indeed, Rust is skeptical:

```
error[E0106]: missing lifetime specifier
--> references_in_struct.rs:7:12
   |
 7 |         r: &i32
   |           ^ expected lifetime parameter
```

Whenever a reference type appears inside another type's definition, you must write out its lifetime. You can write this:

```
struct S {
    r: &'static i32
}
```

This says that `r` can only refer to `i32` values that will last for the lifetime of the program, which is rather limiting. The alternative is to give the type a lifetime parameter `'a`, and use that for `r`:

```
struct S<'a> {
    r: &'a i32
}
```

Now the `S` type has a lifetime, just as reference types do. Each value you create of type `S` gets a fresh lifetime `'a`, which becomes constrained by how you use the value. The lifetime of any reference you store in `r` had better enclose `'a`, and `'a` must outlast the lifetime of wherever you store the `S`.

Turning back to the preceding code, the expression `S { r: &x }` creates a fresh `S` value with some lifetime `'a`. When you store `&x` in the `r` field, you constrain `'a` to lie entirely within `x`'s lifetime.

The assignment `s = S { ... }` stores this `S` in a variable whose lifetime extends to the end of the example, constraining `'a` to outlast the lifetime of `s`. And now Rust has arrived at the same contradictory constraints as before: `'a` must not outlive `x`, yet must live at least as long as `s`. No satisfactory lifetime exists, and Rust rejects the code. Disaster averted!

How does a type with a lifetime parameter behave when placed inside some other type?

```
struct T {  
    s: S // not adequate  
}
```

Rust is skeptical, just as it was when we tried placing a reference in `S` without specifying its lifetime:

```
error[E0106]: missing lifetime specifier  
--> references_in_nested_struct.rs:8:8  
   |  
 8 |     s: S // not adequate  
   |         ^ expected lifetime parameter
```

We can't leave off `S`'s lifetime parameter here: Rust needs to know how a `T`'s lifetime relates to that of the reference in its `S`, in order to apply the same checks to `T` that it does for `S` and plain references.

We could give `s` the `'static` lifetime. This works:

```
struct T {  
    s: S<'static>  
}
```

With this definition, the `s` field may only borrow values that live for the entire execution of the program. That's somewhat restrictive, but it does mean that a `T` can't possibly borrow a local variable; there are no special constraints on a `T`'s lifetime.

The other approach would be to give `T` its own lifetime parameter, and pass that to `S`:

```
struct T<'a> {  
    s: S<'a>  
}
```

By taking a lifetime parameter `'a` and using it in `s`'s type, we've allowed Rust to relate a `T` value's lifetime to that of the reference its `S` holds.

We showed earlier how a function's signature exposes what it does with the references we pass it. Now we've shown something similar about types: a type's lifetime parameters always reveal whether it contains references with interesting (that is, non-`'static`) lifetimes, and what those lifetimes can be.

For example, suppose we have a parsing function that takes a slice of bytes, and returns a structure holding the results of the parse:

```
fn parse_record<'i>(input: &'i [u8]) -> Record<'i> { ... }
```

Without looking into the definition of the `Record` type at all, we can tell that, if we receive a `Record` from `parse_record`, whatever references it contains must point into the input buffer we passed in, and nowhere else (except perhaps at `'static` values).

In fact, this exposure of internal behavior is the reason Rust requires types that contain references to take explicit lifetime parameters. There's no reason Rust couldn't simply make up a distinct lifetime for each reference in the struct, and save you the trouble of writing them out. Early versions of Rust actually behaved this way, but developers found it confusing: it is helpful to know when one value borrows something from another value, especially when working through errors.

It's not just references and types like `S` that have lifetimes. Every type in Rust has a lifetime, including `i32` and `String`. Most are simply `'static`, meaning that values of those types can live for as long as you like; for example, a `Vec<i32>` is self-contained, and needn't be dropped before any particular variable goes out of scope. But a type like `Vec<&'a i32>` has a lifetime that must be enclosed by `'a`: it must be dropped while its referents are still alive.

## Distinct Lifetime Parameters

Suppose you've defined a structure containing two references like this:

```
struct S<'a> {  
    x: &'a i32,  
    y: &'a i32  
}
```

Both references use the same lifetime `'a`. This could be a problem if your code wants to do something like this:

```
let x = 10;  
let r;  
{  
    let y = 20;  
    {  
        let s = S { x: &x, y: &y };  
        r = s.x;  
    }  
}
```

This code doesn't create any dangling pointers. The reference to `y` stays in `s`, which goes out of scope before `y` does. The reference to `x` ends up in `r`, which doesn't outlive `x`.

If you try to compile this, however, Rust will complain that `y` does not live long enough, even though it clearly does. Why is Rust worried? If you work through the code carefully, you can follow its reasoning:

- Both fields of `S` are references with the same lifetime `'a`, so Rust must find a single lifetime that works for both `s.x` and `s.y`.
- We assign `r = s.x`, requiring `'a` to enclose `r`'s lifetime.
- We initialized `s.y` with `&y`, requiring `'a` to be no longer than `y`'s lifetime.

These constraints are impossible to satisfy: no lifetime is shorter than `y`'s scope, but longer than `r`'s. Rust balks.

The problem arises because both references in `S` have the same lifetime `'a`. Changing the definition of `S` to let each reference have a distinct lifetime fixes everything:

```
struct S<'a, 'b> {  
    x: &'a i32,  
    y: &'b i32  
}
```

With this definition, `s.x` and `s.y` have independent lifetimes. What we do with `s.x` has no effect on what we store in `s.y`, so it's easy to satisfy the constraints now: `'a` can simply be `r`'s lifetime, and `'b` can be `s`'s. (`y`'s lifetime would work too for `'b`, but Rust tries to choose the smallest lifetime that works.) Everything ends up fine.

Function signatures can have similar effects. Suppose we have a function like this:

```
fn f<'a>(r: &'a i32, s: &'a i32) -> &'a i32 { r } // perhaps too tight
```

Here, both reference parameters use the same lifetime `'a`, which can unnecessarily constrain the caller in the same way we've shown previously. If this is a problem, you can let parameters' lifetimes vary independently:

```
fn f<'a, 'b>(r: &'a i32, s: &'b i32) -> &'a i32 { r } // looser
```

The downside to this is that adding lifetimes can make types and function signatures harder to read. Your authors tend to try the simplest possible definition first, and then loosen restrictions until the code compiles. Since Rust won't permit the code to run unless it's safe, simply waiting to be told when there's a problem is a perfectly acceptable tactic.

## Omitting Lifetime Parameters

We've shown plenty of functions so far in this book that return references or take them as parameters, but we've usually not needed to spell out which lifetime is which. The lifetimes are there; Rust is just letting us omit them when it's reasonably obvious what they should be.

In the simplest case, if your function doesn't return any references (or other types that require lifetime parameters), then you never need to write out lifetimes for your parameters. Rust just assigns a distinct lifetime to each spot that needs one. For example:

```
struct S<'a, 'b> {
    x: &'a i32,
    y: &'b i32
}

fn sum_r_xy(r: &i32, s: S) -> i32 {
    r + s.x + s.y
}
```

This function's signature is shorthand for:

```
fn sum_r_xy<'a, 'b, 'c>(r: &'a i32, s: S<'b, 'c>) -> i32
```

If you do return references or other types with lifetime parameters, Rust still tries to make the unambiguous cases easy. If there's only a single lifetime that appears among your function's parameters, then Rust assumes any lifetimes in your return value must be that one:

```
fn first_third(point: &[i32; 3]) -> (&i32, &i32) {
    (&point[0], &point[2])
}
```

With all the lifetimes written out, the equivalent would be:

```
fn first_third<'a>(point: &'a [i32; 3]) -> (&'a i32, &'a i32)
```

If there are multiple lifetimes among your parameters, then there's no natural reason to prefer one over the other for the return value, and Rust makes you spell out what's going on.

But as one final shorthand, if your function is a method on some type and takes its self parameter by reference, then that breaks the tie: Rust assumes that self's lifetime is the one to give everything in your return value. (A self parameter refers to the value the method is being called on, Rust's equivalent of this in C++, Java, or JavaScript, or self in Python. We'll cover methods in [“Defining Methods with impl” on page 198.](#))

For example, you can write the following:

```
struct StringTable {
    elements: Vec<String>,
}

impl StringTable {
    fn find_by_prefix(&self, prefix: &str) -> Option<&String> {
        for i in 0 .. self.elements.len() {
            if self.elements[i].starts_with(prefix) {
```

```

        return Some(&self.elements[i]);
    }
    }
    None
}
}

```

The `find_by_prefix` method's signature is shorthand for:

```
fn find_by_prefix<'a, 'b>(&'a self, prefix: &'b str) -> Option<&'a String>
```

Rust assumes that whatever you're borrowing, you're borrowing from `self`.

Again, these are just abbreviations, meant to be helpful without introducing surprises. When they're not what you want, you can always write the lifetimes out explicitly.

## Sharing Versus Mutation

So far, we've discussed how Rust ensures no reference will ever point to a variable that has gone out of scope. But there are other ways to introduce dangling pointers. Here's an easy case:

```

let v = vec![4, 8, 19, 27, 34, 10];
let r = &v;
let aside = v; // move vector to aside
r[0];          // bad: uses `v`, which is now uninitialized

```

The assignment to `aside` moves the vector, leaving `v` uninitialized, turning `r` into a dangling pointer, as shown in [Figure 5-7](#).

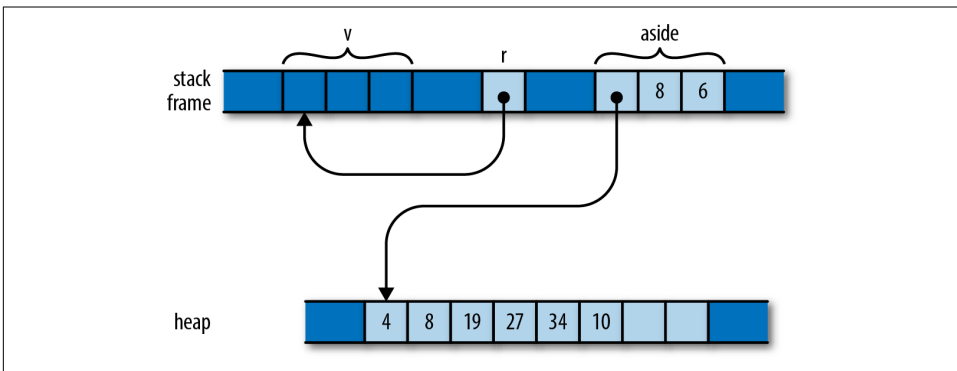

Figure 5-7. A reference to a vector that has been moved away

Although `v` stays in scope for `r`'s entire lifetime, the problem here is that `v`'s value gets moved elsewhere, leaving `v` uninitialized while `r` still refers to it. Naturally, Rust catches the error:



```

error[E0505]: cannot move out of `v` because it is borrowed
--> references_sharing_vs_mutation_1.rs:10:9
  |
 9 |     let r = &v;
  |           - borrow of `v` occurs here
10 |     let aside = v; // move vector to aside
  |           ^^^^^ move out of `v` occurs here

```

Throughout its lifetime, a shared reference makes its referent read-only: you may not assign to the referent or move its value elsewhere. In this code, `r`'s lifetime contains the attempt to move the vector, so Rust rejects the program. If you change the program as shown here, there's no problem:

```

let v = vec![4, 8, 19, 27, 34, 10];
{
    let r = &v;
    r[0]; // ok: vector is still there
}
let aside = v;

```

In this version, `r` goes out of scope earlier, the reference's lifetime ends before `v` is moved aside, and all is well.

Here's a different way to wreak havoc. Suppose we have a handy function to extend a vector with the elements of a slice:

```

fn extend(vec: &mut Vec<f64>, slice: &[f64]) {
    for elt in slice {
        vec.push(*elt);
    }
}

```

This is a less flexible (and much less optimized) version of the standard library's `extend_from_slice` method on vectors. We can use it to build up a vector from slices of other vectors or arrays:

```

let mut wave = Vec::new();
let head = vec![0.0, 1.0];
let tail = [0.0, -1.0];

extend(&mut wave, &head); // extend wave with another vector
extend(&mut wave, &tail); // extend wave with an array

assert_eq!(wave, vec![0.0, 1.0, 0.0, -1.0]);

```

So we've built up one period of a sine wave here. If we want to add another undulation, can we append the vector to itself?

```

extend(&mut wave, &wave);
assert_eq!(wave, vec![0.0, 1.0, 0.0, -1.0,
                    0.0, 1.0, 0.0, -1.0]);

```

This may look fine on casual inspection. But remember that when we add an element to a vector, if its buffer is full, it must allocate a new buffer with more space. Suppose `wave` starts with space for four elements, and so must allocate a larger buffer when `extend` tries to add a fifth. Memory ends up looking like [Figure 5-8](#).

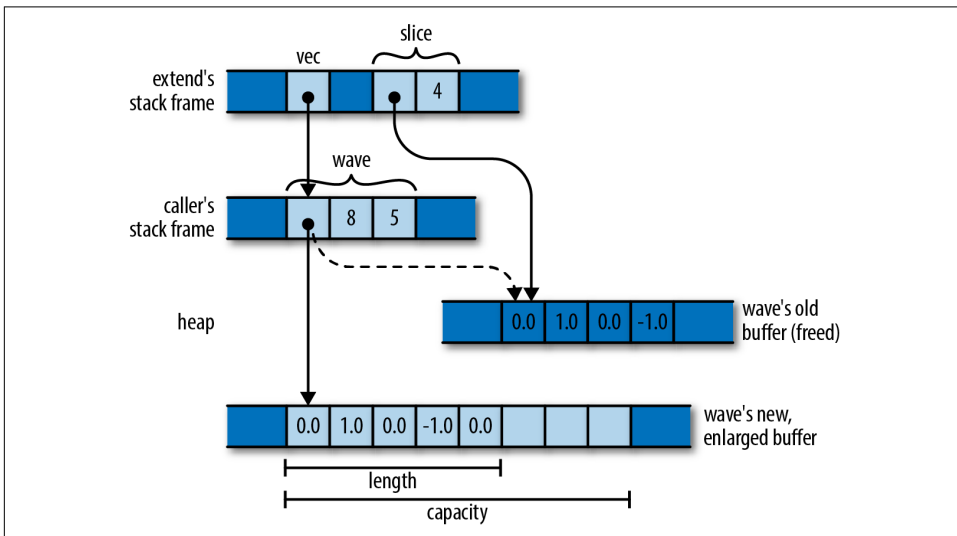

Figure 5-8. A slice turned into a dangling pointer by a vector reallocation

The `extend` function's `vec` argument borrows `wave` (owned by the caller), which has allocated itself a new buffer with space for eight elements. But `slice` continues to point to the old four-element buffer, which has been dropped.

This sort of problem isn't unique to Rust: modifying collections while pointing into them is delicate territory in many languages. In C++, the `std::vector` specification cautions you that "reallocation [of the vector's buffer] invalidates all the references, pointers, and iterators referring to the elements in the sequence." Similarly, Java says, of modifying a `java.util.Hashtable` object:

[I]f the `Hashtable` is structurally modified at any time after the iterator is created, in any way except through the iterator's own `remove` method, the iterator will throw a `ConcurrentModificationException`.

What's especially difficult about this sort of bug is that it doesn't happen all the time. In testing, your vector might always happen to have enough space, the buffer might never be reallocated, and the problem might never come to light.

Rust, however, reports the problem with our call to `extend` at compile time:

```
error[E0502]: cannot borrow `wave` as immutable because it is also borrowed as mutable
--> references_sharing_vs_mutation_2.rs:9:24
|
9 |     extend(&mut wave, &wave);
|           ^^^^^- mutable borrow ends here
|           |
|           |   immutable borrow occurs here
|           |   mutable borrow occurs here
```

In other words, we may borrow a mutable reference to the vector, and we may borrow a shared reference to its elements, but those two references' lifetimes may not overlap. In our case, both references' lifetimes contain the call to `extend`, so Rust rejects the code.

These errors both stem from violations of Rust's rules for mutation and sharing:

- *Shared access is read-only access.* Values borrowed by shared references are read-only. Across the lifetime of a shared reference, neither its referent, nor anything reachable from that referent, can be changed *by anything*. There exist no live mutable references to anything in that structure; its owner is held read-only; and so on. It's really frozen.
- *Mutable access is exclusive access.* A value borrowed by a mutable reference is reachable exclusively via that reference. Across the lifetime of a mutable reference, there is no other usable path to its referent, or to any value reachable from there. The only references whose lifetimes may overlap with a mutable reference are those you borrow from the mutable reference itself.

Rust reported the `extend` example as a violation of the second rule: since we've borrowed a mutable reference to `wave`, that mutable reference must be the only way to reach the vector or its elements. The shared reference to the slice is itself another way to reach the elements, violating the second rule.

But Rust could also have treated our bug as a violation of the first rule: since we've borrowed a shared reference to `wave`'s elements, the elements and the `Vec` itself are all read-only. You can't borrow a mutable reference to a read-only value.

Each kind of reference affects what we can do with the values along the owning path to the referent, and the values reachable from the referent ([Figure 5-9](#)).

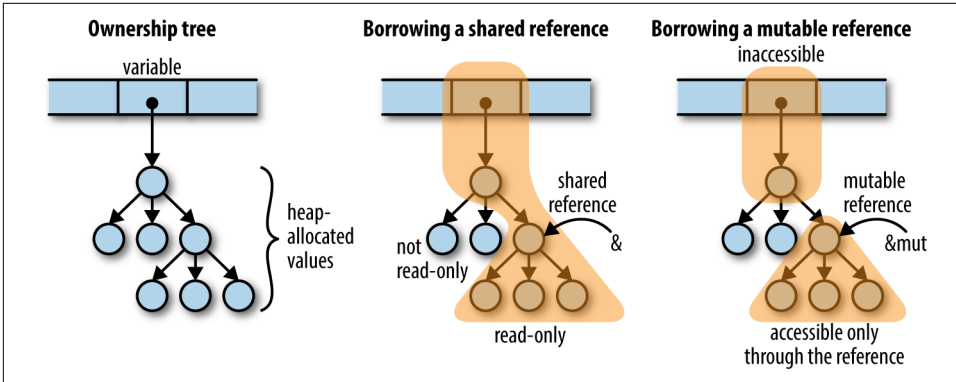

Figure 5-9. Borrowing a reference affects what you can do with other values in the same ownership tree

Note that in both cases, the path of ownership leading to the referent cannot be changed for the reference’s lifetime. For a shared borrow, the path is read-only; for a mutable borrow, it’s completely inaccessible. So there’s no way for the program to do anything that will invalidate the reference.

Paring these principles down to the simplest possible examples:

```

let mut x = 10;
let r1 = &x;
let r2 = &x;    // ok: multiple shared borrows permitted
x += 10;        // error: cannot assign to `x` because it is borrowed
let m = &mut x; // error: cannot borrow `x` as mutable because it is
                // also borrowed as immutable

let mut y = 20;
let m1 = &mut y;
let m2 = &mut y; // error: cannot borrow as mutable more than once
let z = y;       // error: cannot use `y` because it was mutably borrowed

```

It is OK to reborrow a shared reference from a shared reference:

```

let mut w = (107, 109);
let r = &w;
let r0 = &r.0;    // ok: reborrowing shared as shared
let m1 = &mut r.1; // error: can't reborrow shared as mutable

```

You can reborrow from a mutable reference:

```

let mut v = (136, 139);
let m = &mut v;
let m0 = &mut m.0; // ok: reborrowing mutable from mutable
*m0 = 137;
let r1 = &m.1;     // ok: reborrowing shared from mutable,
                  // and doesn't overlap with m0
v.1;              // error: access through other paths still forbidden

```

These restrictions are pretty tight. Turning back to our attempted call `extend(&mut wave, &wave)`, there's no quick and easy way to fix up the code to work the way we'd like. And Rust applies these rules everywhere: if we borrow, say, a shared reference to a key in a `HashMap`, we can't borrow a mutable reference to the `HashMap` until the shared reference's lifetime ends.

But there's good justification for this: designing collections to support unrestricted, simultaneous iteration and modification is difficult, and often precludes simpler, more efficient implementations. Java's `Hashtable` and C++'s `vector` don't bother, and neither Python dictionaries nor JavaScript objects define exactly how such access behaves. Other collection types in JavaScript do, but require heavier implementations as a result. C++'s `std::map` promises that inserting new entries doesn't invalidate pointers to other entries in the map, but by making that promise, the standard precludes more cache-efficient designs like Rust's `BTreeMap`, which stores multiple entries in each node of the tree.

Here's another example of the kind of bug these rules catch. Consider the following C++ code, meant to manage a file descriptor. To keep things simple, we're only going to show a constructor and a copying assignment operator, and we're going to omit error handling:

```
struct File {
    int descriptor;

    File(int d) : descriptor(d) { }

    File& operator=(const File &rhs) {
        close(descriptor);
        descriptor = dup(rhs.descriptor);
    }
};
```

The assignment operator is simple enough, but fails badly in a situation like this:

```
File f(open("foo.txt", ...));
...
f = f;
```

If we assign a `File` to itself, both `rhs` and `*this` are the same object, so `operator=` closes the very file descriptor it's about to pass to `dup`. We destroy the same resource we were meant to copy.

In Rust, the analogous code would be:

```
struct File {
    descriptor: i32
}

fn new_file(d: i32) -> File {
    File { descriptor: d }
}
```

```

}

fn clone_from(this: &mut File, rhs: &File) {
    close(this.descriptor);
    this.descriptor = dup(rhs.descriptor);
}

```

(This is not idiomatic Rust. There are excellent ways to give Rust types their own constructor functions and methods, which we describe in [Chapter 9](#), but the preceding definitions work for this example.)

If we write the Rust code corresponding to the use of `File`, we get:

```

let mut f = new_file(open("foo.txt", ...));
...
clone_from(&mut f, &f);

```

Rust, of course, refuses to even compile this code:

```

error[E0502]: cannot borrow `f` as immutable because it is also
borrowed as mutable
  --> references_self_assignment.rs:18:25
   |
18 |         clone_from(&mut f, &f);
   |                   -   ^- mutable borrow ends here
   |                   |   |
   |                   |   immutable borrow occurs here
   |                   mutable borrow occurs here

```

This should look familiar. It turns out that two classic C++ bugs—failure to cope with self-assignment, and using invalidated iterators—are the same underlying kind of bug! In both cases, code assumes it is modifying one value while consulting another, when in fact they’re both the same value. If you’ve ever accidentally let the source and destination of a call to `memcpy` or `strcpy` call overlap in C or C++, that’s yet another form the bug can take. By requiring mutable access to be exclusive, Rust has fended off a wide class of everyday mistakes.

The immiscibility of shared and mutable references really demonstrates its value when writing concurrent code. A data race is possible only when some value is both mutable and shared between threads—which is exactly what Rust’s reference rules eliminate. A concurrent Rust program that avoids `unsafe` code is free of data races *by construction*. We’ll cover this aspect in more detail when we talk about concurrency in [Chapter 19](#), but in summary, concurrency is much easier to use in Rust than in most other languages.

## Rust's Shared References Versus C's Pointers to const

On first inspection, Rust's shared references seem to closely resemble C and C++'s pointers to const values. However, Rust's rules for shared references are much stricter. For example, consider the following C code:

```
int x = 42;           // int variable, not const
const int *p = &x;   // pointer to const int
assert(*p == 42);
x++;                 // change variable directly
assert(*p == 43);    // "constant" referent's value has changed
```

The fact that `p` is a `const int *` means that you can't modify its referent via `p` itself: `(*p)++` is forbidden. But you can also get at the referent directly as `x`, which is not `const`, and change its value that way. The C family's `const` keyword has its uses, but constant it is not.

In Rust, a shared reference forbids all modifications to its referent, until its lifetime ends:

```
let mut x = 42;       // nonconst i32 variable
let p = &x;           // shared reference to i32
assert_eq!(*p, 42);
x += 1;               // error: cannot assign to x because it is borrowed
assert_eq!(*p, 42);  // if you take out the assignment, this is true
```

To ensure a value is constant, we need to keep track of all possible paths to that value, and make sure that they either don't permit modification or cannot be used at all. C and C++ pointers are too unrestricted for the compiler to check this. Rust's references are always tied to a particular lifetime, making it feasible to check them at compile time.

## Taking Arms Against a Sea of Objects

Since the rise of automatic memory management in the 1990s, the default architecture of all programs has been the *sea of objects*, shown in [Figure 5-10](#).

This is what happens if you have garbage collection and you start writing a program without designing anything. We've all built systems that look like this.

This architecture has many advantages that don't show up in the diagram: initial progress is rapid, it's easy to hack stuff in, and a few years down the road, you'll have no difficulty justifying a complete rewrite. (Cue AC/DC's "Highway to Hell.")

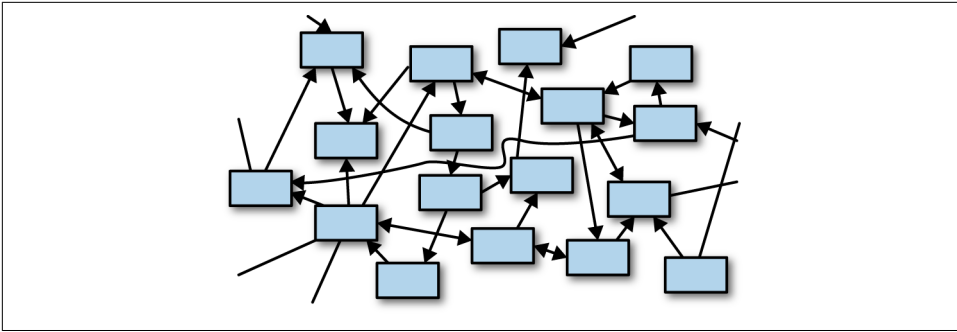

Figure 5-10. A sea of objects

Of course, there are disadvantages too. When everything depends on everything else like this, it's hard to test, evolve, or even think about any component in isolation.

One fascinating thing about Rust is that the ownership model puts a speed bump on the highway to hell. It takes a bit of effort to make a cycle in Rust—two values such that each one contains a reference pointing to the other. You have to use a smart pointer type, such as `Rc`, and **interior mutability**—a topic we haven't even covered yet. Rust prefers for pointers, ownership, and data flow to pass through the system in one direction, as shown in [Figure 5-11](#).

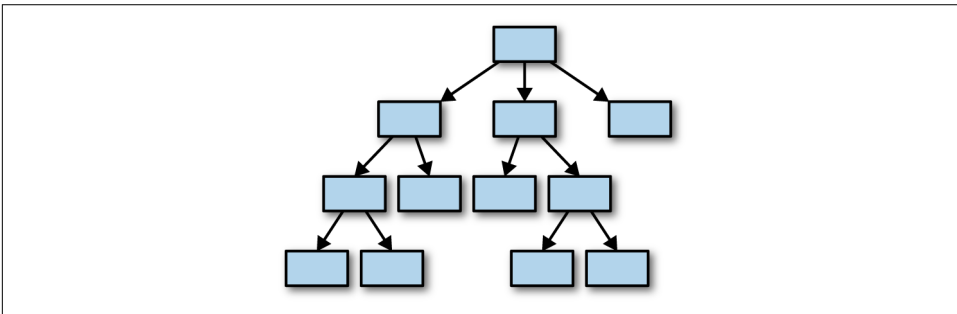

Figure 5-11. A tree of values

The reason we bring this up right now is that it would be natural, after reading this chapter, to want to run right out and create a “sea of structs,” all tied together with `Rc` smart pointers, and re-create all the object-oriented antipatterns you're familiar with. This won't work for you right away. Rust's ownership model will give you some trouble. The cure is to do some up-front design and build a better program.

Rust is all about transferring the pain of understanding your program from the future to the present. It works unreasonably well: not only can Rust force you to understand why your program is thread-safe, it can even require some amount of high-level architectural design.



---

# Expressions

*LISP programmers know the value of everything, but the cost of nothing.*

—Alan Perlis, epigram #55

In this chapter, we'll cover the *expressions* of Rust, the building blocks that make up the body of Rust functions. A few concepts, such as closures and iterators, are deep enough that we will dedicate a whole chapter to them later on. For now, we aim to cover as much syntax as possible in a few pages.

## An Expression Language

Rust visually resembles the C family of languages, but this is a bit of a ruse. In C, there is a sharp distinction between *expressions*, bits of code that look something like this:

```
5 * (fahr-32) / 9
```

and *statements*, which look more like this:

```
for (; begin != end; ++begin) {  
    if (*begin == target)  
        break;  
}
```

Expressions have values. Statements don't.

Rust is what is called an *expression language*. This means it follows an older tradition, dating back to Lisp, where expressions do all the work.

In C, `if` and `switch` are statements. They don't produce a value, and they can't be used in the middle of an expression. In Rust, `if` and `match` *can* produce values. We already saw a `match` expression that produces a numeric value in [Chapter 2](#):

```

pixels[r * bounds.0 + c] =
    match escapes(Complex { re: point.0, im: point.1 }, 255) {
        None => 0,
        Some(count) => 255 - count as u8
    };

```

An `if` expression can be used to initialize a variable:

```

let status =
    if cpu.temperature <= MAX_TEMP {
        HttpStatus::Ok
    } else {
        HttpStatus::ServerError // server melted
    };

```

A `match` expression can be passed as an argument to a function or macro:

```

println!("Inside the vat, you see {}.",
    match vat.contents {
        Some(brain) => brain.desc(),
        None => "nothing of interest"
    });

```

This explains why Rust does not have C's ternary operator ( $expr1 ? expr2 : expr3$ ). In C, it is a handy expression-level analogue to the `if` statement. It would be redundant in Rust: the `if` expression handles both cases.

Most of the control flow tools in C are statements. In Rust, they are all expressions.

## Blocks and Semicolons

Blocks, too, are expressions. A block produces a value and can be used anywhere a value is needed:

```

let display_name = match post.author() {
    Some(author) => author.name(),
    None => {
        let network_info = post.get_network_metadata()?;
        let ip = network_info.client_address();
        ip.to_string()
    }
};

```

The code after `Some(author) =>` is the simple expression `author.name()`. The code after `None =>` is a block expression. It makes no difference to Rust. The value of the block is the value of its last expression, `ip.to_string()`.

Note that there is no semicolon after that expression. Most lines of Rust code do end with either a semicolon or curly braces, just like C or Java. And if a block looks like C code, with semicolons in all the familiar places, then it will run just like a C block, and its value will be `()`. As we mentioned in [Chapter 2](#), when you leave the semicolon

off the last line of a block, you're making that block produce a value—the value of the final expression.

In some languages, particularly JavaScript, you're allowed to omit semicolons, and the language simply fills them in for you—a minor convenience. This is different. In Rust, the semicolon actually means something.

```
let msg = {
    // let-declaration: semicolon is always required
    let dandelion_control = puffball.open();

    // expression + semicolon: method is called, return value dropped
    dandelion_control.release_all_seeds(launch_codes);

    // expression with no semicolon: method is called,
    // return value stored in `msg`
    dandelion_control.get_status()
};
```

This ability of blocks to contain declarations and also produce a value at the end is a neat feature, one that quickly comes to feel natural. The one drawback is that it leads to an odd error message when you leave out a semicolon by accident.

```
...
if preferences.changed() {
    page.compute_size() // oops, missing semicolon
}
...
```

If you made this mistake in a C or Java program, the compiler would simply point out that you're missing a semicolon. Here's what Rust says:

```
error[E0308]: mismatched types
--> expressions_missing_semicolon.rs:19:9
   |
19 |         page.compute_size() // oops, missing semicolon
   |         ^^^^^^^^^^^^^^^^^^^^^^^^^^^^^^^^^ expected (), found tuple
   |
   = note: expected type `()`
           found type `(u32, u32)`
```

Rust assumes you've omitted this semicolon on purpose; it doesn't consider the possibility that it's just a typo. A confused error message is the result. When you see `expected type `()``, look for a missing semicolon first.

*Empty statements* are also allowed in blocks. An empty statement consists of a stray semicolon, all by itself:

```
loop {
    work();
    play();
};
```

```
    ;           // <-- empty statement
}
```

Rust follows the tradition of C in allowing this. Empty statements do nothing except convey a slight feeling of melancholy. We mention them only for completeness.

## Declarations

In addition to expressions and semicolons, a block may contain any number of declarations. The most common are `let` declarations, which declare local variables:

```
let name: type = expr;
```

The type and initializer are optional. The semicolon is required.

A `let` declaration can declare a variable without initializing it. The variable can then be initialized with a later assignment. This is occasionally useful, because sometimes a variable should be initialized from the middle of some sort of control flow construct:

```
let name;
if user.has_nickname() {
    name = user.nickname();
} else {
    name = generate_unique_name();
    user.register(&name);
}
```

Here there are two different ways the local variable `name` might be initialized, but either way it will be initialized exactly once, so `name` does not need to be declared `mut`.

It's an error to use a variable before it's initialized. (This is closely related to the error of using a value after it's been moved. Rust really wants you to use values only while they exist!)

You may occasionally see code that seems to redeclare an existing variable, like this:

```
for line in file.lines() {
    let line = line?;
    ...
}
```

This is equivalent to:

```
for line_result in file.lines() {
    let line = line_result?;
    ...
}
```

The `let` declaration creates a new, second variable, of a different type. The type of `line_result` is `Result<String, io::Error>`. The second variable, `line`, is a `String`. It's legal to give the second variable the same name as the first. In this book, we'll stick to using a `_result` suffix in such situations, so that all variables have distinct names.

A block can also contain *item declarations*. An item is simply any declaration that could appear globally in a program or module, such as a `fn`, `struct`, or `use`.

Later chapters will cover items in detail. For now, `fn` makes a sufficient example. Any block may contain a `fn`:

```
use std::io;
use std::cmp::Ordering;

fn show_files() -> io::Result<()> {
    let mut v = vec![];
    ...

    fn cmp_by_timestamp_then_name(a: &FileInfo, b: &FileInfo) -> Ordering {
        a.timestamp.cmp(&b.timestamp) // first, compare timestamps
        .reverse() // newest file first
        .then(a.path.cmp(&b.path)) // compare paths to break ties
    }

    v.sort_by(cmp_by_timestamp_then_name);
    ...
}
```

When a `fn` is declared inside a block, its scope is the entire block—that is, it can be *used* throughout the enclosing block. But a nested `fn` cannot access local variables or arguments that happen to be in scope. For example, the function `cmp_by_timestamp_then_name` could not use `v` directly. (Rust also has closures, which do see into enclosing scopes. See [Chapter 14](#).)

A block can even contain a whole module. This may seem a bit much—do we really need to be able to nest *every* piece of the language inside every other piece?—but programmers (and particularly programmers using macros) have a way of finding uses for every scrap of orthogonality the language provides.

## if and match

The form of an `if` expression is familiar:

```
if condition1 {
    block1
} else if condition2 {
    block2
} else {
    block_n
}
```

Each *condition* must be an expression of type `bool`; true to form, Rust does not implicitly convert numbers or pointers to Boolean values.

Unlike C, parentheses are not required around conditions. In fact, `rustc` will emit a warning if unnecessary parentheses are present. The curly braces, however, are required.

The `else if` blocks, as well as the final `else`, are optional. An `if` expression with no `else` block behaves exactly as though it had an empty `else` block.

`match` expressions are something like the C `switch` statement, but more flexible. A simple example:

```
match code {
    0 => println!("OK"),
    1 => println!("Wires Tangled"),
    2 => println!("User Asleep"),
    _ => println!("Unrecognized Error {}", code)
}
```

This is something a `switch` statement could do. Exactly one of the four arms of this `match` expression will execute, depending on the value of `code`. The wildcard pattern `_` matches everything, so it serves as the default case.

The compiler can optimize this kind of `match` using a jump table, just like a `switch` statement in C++. A similar optimization is applied when each arm of a `match` produces a constant value. In that case, the compiler builds an array of those values, and the `match` is compiled into an array access. Apart from a bounds check, there is no branching at all in the compiled code.

The versatility of `match` stems from the variety of supported *patterns* that can be used to the left of `=>` in each arm. Above, each pattern is simply a constant integer. We've also shown `match` expressions that distinguish the two kinds of `Option` value:

```
match params.get("name") {
    Some(name) => println!("Hello, {}!", name),
    None => println!("Greetings, stranger.")
}
```

This is only a hint of what patterns can do. A pattern can match a range of values. It can unpack tuples. It can match against individual fields of structs. It can chase references, borrow parts of a value, and more. Rust's patterns are a mini-language of their own. We'll dedicate several pages to them in [Chapter 10](#).

The general form of a `match` expression is:

```
match value {
    pattern => expr,
    ...
}
```

The comma after an arm may be dropped if the `expr` is a block.

Rust checks the given *value* against each pattern in turn, starting with the first. When a pattern matches, the corresponding *expr* is evaluated and the *match* expression is complete; no further patterns are checked. At least one of the patterns must match. Rust prohibits *match* expressions that do not cover all possible values:

```
let score = match card.rank {
    Jack => 10,
    Queen => 10,
    Ace => 11
}; // error: nonexhaustive patterns
```

All blocks of an *if* expression must produce values of the same type:

```
let suggested_pet =
    if with_wings { Pet::Buzzard } else { Pet::Hyena }; // ok

let favorite_number =
    if user.is_hobbit() { "eleventy-one" } else { 9 }; // error

let best_sports_team =
    if is_hockey_season() { "Predators" }; // error
```

(The last example is an error because in July, the result would be `()`.)

Similarly, all arms of a *match* expression must have the same type:

```
let suggested_pet =
    match favorites.element {
        Fire => Pet::RedPanda,
        Air => Pet::Buffalo,
        Water => Pet::Orca,
        _ => None // error: incompatible types
    };
```

## if let

There is one more *if* form, the *if let* expression:

```
if let pattern = expr {
    block1
} else {
    block2
}
```

The given *expr* either matches the *pattern*, in which case *block1* runs, or it doesn't, and *block2* runs. Sometimes this is a nice way to get data out of an `Option` or `Result`:

```
if let Some(cookie) = request.session_cookie {
    return restore_session(cookie);
}

if let Err(err) = present_cheesy_anti_robot_task() {
    log_robot_attempt(err);
}
```

```

    politely_accuse_user_of_being_a_robot();
} else {
    session.mark_as_human();
}

```

It's never strictly *necessary* to use `if let`, because `match` can do everything `if let` can do. An `if let` expression is shorthand for a `match` with just one pattern:

```

match expr {
    pattern => { block1 }
    _ => { block2 }
}

```

## Loops

There are four looping expressions:

```

while condition {
    block
}

while let pattern = expr {
    block
}

loop {
    block
}

for pattern in collection {
    block
}

```

Loops are expressions in Rust, but they don't produce useful values. The value of a loop is `()`.

A `while` loop behaves exactly like the C equivalent, except that again, the *condition* must be of the exact type `bool`.

The `while let` loop is analogous to `if let`. At the beginning of each loop iteration, the value of *expr* either matches the given *pattern*, in which case the block runs, or it doesn't, in which case the loop exits.

Use `loop` to write infinite loops. It executes the *block* repeatedly forever (or until a `break` or `return` is reached, or the thread panics).

A `for` loop evaluates the *collection* expression, then evaluates the *block* once for each value in the collection. Many collection types are supported. The standard C `for` loop:



```

for (int i = 0; i < 20; i++) {
    printf("%d\n", i);
}

```

is written like this in Rust:

```

for i in 0..20 {
    println!("{}", i);
}

```

As in C, the last number printed is 19.

The `..` operator produces a *range*, a simple struct with two fields: `start` and `end`. `0..20` is the same as `std::ops::Range { start: 0, end: 20 }`. Ranges can be used with `for` loops because `Range` is an iterable type: it implements the `std::iter::IntoIterator` trait, which we'll discuss in [Chapter 15](#). The standard collections are all iterable, as are arrays and slices.

In keeping with Rust's move semantics, a `for` loop over a value consumes the value:

```

let strings: Vec<String> = error_messages();
for s in strings { // each String is moved into s here...
    println!("{}", s);
} // ...and dropped here
println!("{}", error(s), strings.len()); // error: use of moved value

```

This can be inconvenient. The easy remedy is to loop over a reference to the collection instead. The loop variable, then, will be a reference to each item in the collection:

```

for rs in &strings {
    println!("String {:?} is at address {:p}.", *rs, rs);
}

```

Here the type of `&strings` is `&Vec<String>` and the type of `rs` is `&String`.

Iterating over a `mut` reference provides a `mut` reference to each element:

```

for rs in &mut strings { // the type of rs is &mut String
    rs.push('\n'); // add a newline to each string
}

```

[Chapter 15](#) covers `for` loops in greater detail and shows many other ways to use iterators.

A `break` expression exits an enclosing loop. (In Rust, `break` works only in loops. It is not necessary in `match` expressions, which are unlike `switch` statements in this regard.)

A `continue` expression jumps to the next loop iteration:

```

// Read some data, one line at a time.
for line in input_lines {
    let trimmed = trim_comments_and_whitespace(line);
    if trimmed.is_empty() {

```

```

        // Jump back to the top of the loop and
        // move on to the next line of input.
        continue;
    }
    ...
}

```

In a for loop, `continue` advances to the next value in the collection. If there are no more values, the loop exits. Similarly, in a while loop, `continue` rechecks the loop condition. If it's now false, the loop exits.

A loop can be *labeled* with a lifetime. In the following example, `'search:` is a label for the outer for loop. Thus `break 'search` exits that loop, not the inner loop.

```

'search:
for room in apartment {
    for spot in room.hiding_spots() {
        if spot.contains(keys) {
            println!("Your keys are {} in the {}.", spot, room);
            break 'search;
        }
    }
}

```

Labels can also be used with `continue`.

## return Expressions

A return expression exits the current function, returning a value to the caller.

`return` without a value is shorthand for `return ()`:

```

fn f() { // return type omitted: defaults to ()
    return; // return value omitted: defaults to ()
}

```

Like a `break` expression, `return` can abandon work in progress. For example, back in [Chapter 2](#), we used the `?` operator to check for errors after calling a function that can fail:

```
let output = File::create(filename)?;
```

and we explained that this is shorthand for a `match` expression:

```

let output = match File::create(filename) {
    Ok(f) => f,
    Err(err) => return Err(err)
};

```

This code starts by calling `File::create(filename)`. If that returns `Ok(f)`, then the whole `match` expression evaluates to `f`, so `f` is stored in `output` and we continue with the next line of code following the `match`.

Otherwise, we'll match `Err(err)` and hit the `return` expression. When that happens, it doesn't matter that we're in the middle of evaluating a `match` expression to determine the value of the variable output. We abandon all of that and exit the enclosing function, returning whatever error we got from `File::create()`.

We'll cover the `?` operator more completely in [“Propagating Errors” on page 152](#).

## Why Rust Has loop

Several pieces of the Rust compiler analyze the flow of control through your program.

- Rust checks that every path through a function returns a value of the expected return type. To do this correctly, it needs to know whether or not it's possible to reach the end of the function.
- Rust checks that local variables are never used uninitialized. This entails checking every path through a function to make sure there's no way to reach a place where a variable is used without having already passed through code that initializes it.
- Rust warns about unreachable code. Code is unreachable if *no* path through the function reaches it.

These are called *flow-sensitive* analyses. They are nothing new; Java has had a “definite assignment” analysis, similar to Rust's, for years.

When enforcing this sort of rule, a language must strike a balance between simplicity, which makes it easier for programmers to figure out what the compiler is talking about sometimes—and cleverness, which can help eliminate false warnings and cases where the compiler rejects a perfectly safe program. Rust went for simplicity. Its flow-sensitive analyses do not examine loop conditions at all, instead simply assuming that any condition in a program can be either true or false.

This causes Rust to reject some safe programs:

```
fn wait_for_process(process: &mut Process) -> i32 {
    while true {
        if process.wait() {
            return process.exit_code();
        }
    }
} // error: not all control paths return a value
```

The error here is bogus. It is not actually possible to reach the end of the function without returning a value.

The `loop` expression is offered as a “say-what-you-mean” solution to this problem.

Rust's type system is affected by control flow, too. Earlier we said that all branches of an `if` expression must have the same type. But it would be silly to enforce this rule on

blocks that end with a `break` or `return` expression, an infinite loop, or a call to `panic!()` or `std::process::exit()`. What all those expressions have in common is that they never finish in the usual way, producing a value. A `break` or `return` exits the current block abruptly; an infinite loop never finishes at all; and so on.

So in Rust, these expressions don't have a normal type. Expressions that don't finish normally are assigned the special type `!`, and they're exempt from the rules about types having to match. You can see `!` in the function signature of `std::process::exit()`:

```
fn exit(code: i32) -> !
```

The `!` means that `exit()` never returns. It's a *divergent function*.

You can write divergent functions of your own using the same syntax, and this is perfectly natural in some cases:

```
fn serve_forever(socket: ServerSocket, handler: ServerHandler) -> ! {
    socket.listen();
    loop {
        let s = socket.accept();
        handler.handle(s);
    }
}
```

Of course, Rust then considers it an error if the function can return normally.

This concludes the part of this chapter that focuses on control flow. The rest covers Rust functions, methods, and operators.

## Function and Method Calls

The syntax for calling functions and methods is the same in Rust as in many other languages:

```
let x = gcd(1302, 462); // function call

let room = player.location(); // method call
```

In the second example here, `player` is a variable of the made-up type `Player`, which has a made-up `.location()` method. (We'll show how to define your own methods when we start talking about user-defined types in [Chapter 9](#).)

Rust usually makes a sharp distinction between references and the values they refer to. If you pass a `&i32` to a function that expects an `i32`, that's a type error. You'll notice that the `.` operator relaxes those rules a bit. In the method call `player.location()`, `player` might be a `Player`, a reference of type `&Player`, or a smart pointer of type `Box<Player>` or `Rc<Player>`. The `.location()` method might take the `player` either by value or by reference. The same `.location()` syntax works in all cases, because

Rust's `.` operator automatically dereferences `player` or borrows a reference to it as needed.

A third syntax is used for calling static methods, like `Vec::new()`.

```
let mut numbers = Vec::new(); // static method call
```

The difference between static and nonstatic methods is the same as in object-oriented languages: nonstatic methods are called on values (like `my_vec.len()`), and static methods are called on types (like `Vec::new()`).

Naturally, method calls can be chained:

```
Iron::new(router).http("localhost:3000").unwrap();
```

One quirk of Rust syntax is that in a function call or method call, the usual syntax for generic types, `Vec<T>`, does not work:

```
return Vec<i32>::with_capacity(1000); // error: something about chained comparisons  
let ramp = (0 .. n).collect<Vec<i32>>(); // same error
```

The problem is that in expressions, `<` is the less-than operator. The Rust compiler helpfully suggests writing `::<T>` instead of `<T>` in this case, and that solves the problem:

```
return Vec::::with_capacity(1000); // ok, using ::<  
let ramp = (0 .. n).collect::
```

The symbol `::<...>` is affectionately known in the Rust community as the *turbofish*.

Alternatively, it is often possible to drop the type parameters and let Rust infer them:

```
return Vec::with_capacity(10); // ok, if the fn return type is Vec<i32>  
let ramp: Vec<i32> = (0 .. n).collect(); // ok, variable's type is given
```

It's considered good style to omit the types whenever they can be inferred.

## Fields and Elements

The fields of a struct are accessed using familiar syntax. Tuples are the same except that their fields have numbers rather than names:

```
game.black_pawns // struct field  
coords.1         // tuple element
```

If the value to the left of the dot is a reference or smart pointer type, it is automatically dereferenced, just as for method calls.

Square brackets access the elements of an array, a slice, or a vector:

```
pieces[i]           // array element
```

The value to the left of the brackets is automatically dereferenced.

Expressions like these three are called *lvalues*, because they can appear on the left side of an assignment:

```
game.black_pawns = 0x00ff0000_00000000_u64;
coords.1 = 0;
pieces[2] = Some(Piece::new(Black, Knight, coords));
```

Of course, this is permitted only if `game`, `coords`, and `pieces` are declared as `mut` variables.

Extracting a slice from an array or vector is straightforward:

```
let second_half = &game_moves[midpoint .. end];
```

Here `game_moves` may be either an array, a slice, or a vector; the result, regardless, is a borrowed slice of length `end - midpoint`. `game_moves` is considered borrowed for the lifetime of `second_half`.

The `..` operator allows either operand to be omitted; it produces up to four different types of object depending on which operands are present:

```
..           // RangeFull
a ..        // RangeFrom { start: a }
.. b       // RangeTo { end: b }
a .. b     // Range { start: a, end: b }
```

Rust ranges are *half-open*: they include the start value, if any, but not the end value. The range `0 .. 4` includes the numbers 0, 1, 2, and 3.

Only ranges that include a start value are iterable, since a loop must have somewhere to start. But in array slicing, all four forms are useful. If the start or end of the range is omitted, it defaults to the start or end of the data being sliced.

So an implementation of quicksort, the classic divide-and-conquer sorting algorithm, might look, in part, like this:

```
fn quicksort<T: Ord>(slice: &mut [T]) {
    if slice.len() <= 1 {
        return; // Nothing to sort.
    }

    // Partition the slice into two parts, front and back.
    let pivot_index = partition(slice);

    // Recursively sort the front half of `slice`.
    quicksort(&mut slice[.. pivot_index]);
}
```

```

    // And the back half.
    quicksort(&mut slice[pivot_index + 1 ..]);
}

```

## Reference Operators

The address-of operators, `&` and `&mut`, are covered in [Chapter 5](#).

The unary `*` operator is used to access the value pointed to by a reference. As we've seen, Rust automatically follows references when you use the `.` operator to access a field or method, so the `*` operator is necessary only when we want to read or write the entire value that the reference points to.

For example, sometimes an iterator produces references, but the program needs the underlying values:

```

let padovan: Vec<u64> = compute_padovan_sequence(n);
for elem in &padovan {
    draw_triangle(turtle, *elem);
}

```

In this example, the type of `elem` is `&u64`, so `*elem` is a `u64`.

## Arithmetic, Bitwise, Comparison, and Logical Operators

Rust's binary operators are like those in many other languages. To save time, we assume familiarity with one of those languages, and focus on the few points where Rust departs from tradition.

Rust has the usual arithmetic operators, `+`, `-`, `*`, `/`, and `%`. As mentioned in [Chapter 3](#), integer overflow is detected, and causes a panic, in debug builds. The standard library provides methods like `a.wrapping_add(b)` for unchecked arithmetic.

Dividing an integer by zero triggers a panic even in release builds. Integers have a method `a.checked_div(b)` that returns an `Option` (`None` if `b` is zero) and never panics.

Unary `-` negates a number. It is supported for all the numeric types except unsigned integers. There is no unary `+` operator.

```

println!("{}", -100); // -100
println!("{}", -100u32); // error: can't apply unary `-` to type `u32`
println!("{}", +100); // error: expected expression, found `+`

```

As in C, `a % b` computes the remainder, or modulus, of division. The result has the same sign as the lefthand operand. Note that `%` can be used on floating-point numbers as well as integers:

```

let x = 1234.567 % 10.0; // approximately 4.567

```

Rust also inherits C's bitwise integer operators, `&`, `|`, `^`, `<<`, and `>>`. However, Rust uses `!` instead of `~` for bitwise NOT:

```
let hi: u8 = 0xe0;
let lo = !hi; // 0x1f
```

This means that `!n` can't be used on an integer `n` to mean "n is zero." For that, write `n == 0`.

Bit shifting is always sign-extending on signed integer types and zero-extending on unsigned integer types. Since Rust has unsigned integers, it does not need Java's `>>>` operator.

Bitwise operations have higher precedence than comparisons, unlike C, so if you write `x & BIT != 0`, that means `(x & BIT) != 0`, as you probably intended. This is much more useful than C's interpretation, `x & (BIT != 0)`, which tests the wrong bit!

Rust's comparison operators are `==`, `!=`, `<`, `<=`, `>`, and `>=`. The two values being compared must have the same type.

Rust also has the two short-circuiting logical operators `&&` and `||`. Both operands must have the exact type `bool`.

## Assignment

The `=` operator can be used to assign to `mut` variables and their fields or elements. But assignment is not as common in Rust as in other languages, since variables are immutable by default.

As described in [Chapter 4](#), assignment *moves* values of noncopyable types, rather than implicitly copying them.

Compound assignment is supported:

```
total += item.price;
```

This is equivalent to `total = total + item.price;` Other operators are supported too: `--`, `*=`, and so forth. The full list is given in [Table 6-1](#), at the end of this chapter.

Unlike C, Rust doesn't support chaining assignment: you can't write `a = b = 3` to assign the value 3 to both `a` and `b`. Assignment is rare enough in Rust that you won't miss this shorthand.

Rust does not have C's increment and decrement operators `++` and `--`.



# Type Casts

Converting a value from one type to another usually requires an explicit cast in Rust. Casts use the `as` keyword:

```
let x = 17;           // x is type i32
let index = x as usize; // convert to usize
```

Several kinds of casts are permitted:

- Numbers may be cast from any of the built-in numeric types to any other.  
Casting an integer to another integer type is always well-defined. Converting to a narrower type results in truncation. A signed integer cast to a wider type is sign-extended; an unsigned integer is zero-extended; and so on. In short, there are no surprises.  
However, as of this writing, casting a large floating-point value to an integer type that is too small to represent it can lead to undefined behavior. This can cause crashes even in safe Rust. It is a bug in the compiler, [github.com/rust-lang/rust/issues/10184](https://github.com/rust-lang/rust/issues/10184).
- Values of type `bool`, `char`, or of a C-like enum type, may be cast to any integer type. (We'll cover enums in [Chapter 10](#).)  
Casting in the other direction is not allowed, as `bool`, `char`, and enum types all have restrictions on their values that would have to be enforced with runtime checks. For example, casting a `u16` to type `char` is banned because some `u16` values, like `0xd800`, correspond to Unicode surrogate code points and therefore would not make valid `char` values. There is a standard method, `std::char::from_u32()`, which performs the runtime check and returns an `Option<char>`; but more to the point, the need for this kind of conversion has grown rare. We typically convert whole strings or streams at once, and algorithms on Unicode text are often nontrivial and best left to libraries.  
As an exception, a `u8` may be cast to type `char`, since all integers from 0 to 255 are valid Unicode code points for `char` to hold.
- Some casts involving unsafe pointer types are also allowed. See [“Raw Pointers” on page 538](#).

We said that a conversion *usually* requires a cast. A few conversions involving reference types are so straightforward that the language performs them even without a cast. One trivial example is converting a `mut` reference to a non-`mut` reference.

Several more significant automatic conversions can happen, though:

- Values of type `&String` auto-convert to type `&str` without a cast.
- Values of type `&Vec<i32>` auto-convert to `&[i32]`.
- Values of type `&Box<Chessboard>` auto-convert to `&Chessboard`.

These are called *deref coercions*, because they apply to types that implement the `Deref` built-in trait. The purpose of `Deref` coercion is to make smart pointer types, like `Box`, behave as much like the underlying value as possible. Using a `Box<Chessboard>` is mostly just like using a plain `Chessboard`, thanks to `Deref`.

User-defined types can implement the `Deref` trait, too. When you need to write your own smart pointer type, see “[Deref and DerefMut](#)” on page 289.

## Closures

Rust has *closures*, lightweight function-like values. A closure usually consists of an argument list, given between vertical bars, followed by an expression:

```
let is_even = |x| x % 2 == 0;
```

Rust infers the argument types and return type. You can also write them out explicitly, as you would for a function. If you do specify a return type, then the body of the closure must be a block, for the sake of syntactic sanity:

```
let is_even = |x: u64| -> bool x % 2 == 0; // error
```

```
let is_even = |x: u64| -> bool { x % 2 == 0 }; // ok
```

Calling a closure uses the same syntax as calling a function:

```
assert_eq!(is_even(14), true);
```

Closures are one of Rust’s most delightful features, and there is a great deal more to be said about them. We shall say it in [Chapter 14](#).

## Precedence and Associativity

[Table 6-1](#) gives a summary of Rust expression syntax. Operators are listed in order of precedence, from highest to lowest. (Like most programming languages, Rust has *operator precedence* to determine the order of operations when an expression contains multiple adjacent operators. For example, in `limit < 2 * broom.size + 1`, the `*` operator has the highest precedence, so the field access happens first.)

Table 6-1. Expressions

Expression type	Example	Related traits
Array literal	[1, 2, 3]	
Repeat array literal	[0; 50]	
Tuple	(6, "crullers")	
Grouping	(2 + 2)	
Block	{ f(); g() }	
Control flow expressions	<pre>if ok { f() } if ok { 1 } else { 0 } if let Some(x) = f() { x } else { 0 } match x { None =&gt; 0, _ =&gt; 1 } for v in e { f(v); } while ok { ok = f(); } while let Some(x) = it.next() { f(x); } loop { next_event(); } break continue return 0</pre>	<code>std::iter::IntoIterator</code>
Macro invocation	println!("ok")	
Path	std::f64::consts::PI	
Struct literal	Point {x: 0, y: 0}	
Tuple field access	pair.0	<code>Deref, DerefMut</code>
Struct field access	point.x	<code>Deref, DerefMut</code>
Method call	point.translate(50, 50)	<code>Deref, DerefMut</code>
Function call	stdin()	<code>Fn(Arg0, ...) -&gt; T, FnMut(Arg0, ...) -&gt; T, FnOnce(Arg0, ...) -&gt; T</code>
Index	arr[0]	<code>Index, IndexMut, Deref, DerefMut</code>
Error check	create_dir("tmp")?	
Logical/bitwise NOT	!ok	<code>Not</code>
Negation	-num	<code>Neg</code>
Dereference	*ptr	<code>Deref, DerefMut</code>
Borrow	&val	
Type cast	x as u32	
Multiplication	n * 2	<code>Mul</code>
Division	n / 2	<code>Div</code>
Remainder (modulus)	n % 2	<code>Rem</code>
Addition	n + 1	<code>Add</code>
Subtraction	n - 1	<code>Sub</code>
Left shift	n << 1	<code>Shl</code>

Expression type	Example	Related traits
Right shift	<code>n &gt;&gt; 1</code>	<code>Shr</code>
Bitwise AND	<code>n &amp; 1</code>	<code>BitAnd</code>
Bitwise exclusive OR	<code>n ^ 1</code>	<code>BitXor</code>
Bitwise OR	<code>n   1</code>	<code>BitOr</code>
Less than	<code>n &lt; 1</code>	<code>std::cmp::PartialOrd</code>
Less than or equal	<code>n &lt;= 1</code>	<code>std::cmp::PartialOrd</code>
Greater than	<code>n &gt; 1</code>	<code>std::cmp::PartialOrd</code>
Greater than or equal	<code>n &gt;= 1</code>	<code>std::cmp::PartialOrd</code>
Equal	<code>n == 1</code>	<code>std::cmp::PartialEq</code>
Not equal	<code>n != 1</code>	<code>std::cmp::PartialEq</code>
Logical AND	<code>x.ok &amp;&amp; y.ok</code>	
Logical OR	<code>x.ok    backup.ok</code>	
Range	<code>start .. stop</code>	
Assignment	<code>x = val</code>	
Compound assignment	<code>x *= 1</code>	<code>MulAssign</code>
	<code>x /= 1</code>	<code>DivAssign</code>
	<code>x %= 1</code>	<code>RemAssign</code>
	<code>x += 1</code>	<code>AddAssign</code>
	<code>x -= 1</code>	<code>SubAssign</code>
	<code>x &lt;&lt;= 1</code>	<code>ShlAssign</code>
	<code>x &gt;&gt;= 1</code>	<code>ShrAssign</code>
	<code>x &amp;= 1</code>	<code>BitAndAssign</code>
	<code>x ^= 1</code>	<code>BitXorAssign</code>
	<code>x  = 1</code>	<code>BitOrAssign</code>
Closure	<code> x, y  x + y</code>	

All of the operators that can usefully be chained are left-associative. That is, a chain of operations such as `a - b - c` is grouped as `(a - b) - c`, not `a - (b - c)`. The operators that can be chained in this way are all the ones you might expect:

```
* / % + - << >> & ^ | && || as
```

The comparison operators, the assignment operators, and the range operator `..` can't be chained at all.

## Onward

Expressions are what we think of as “running code.” They’re the part of a Rust program that compiles to machine instructions. Yet they are a small fraction of the whole language.

The same is true in most programming languages. The first job of a program is to run, but that's not its only job. Programs have to communicate. They have to be testable. They have to stay organized and flexible, so that they can continue to evolve. They have to interoperate with code and services built by other teams. And even just to run, programs in a statically typed language like Rust need some more tools for organizing data than just tuples and arrays.

Coming up, we'll spend several chapters talking about features in this area: modules and crates, which give your program structure, and then structs and enums, which do the same for your data.

First, we'll dedicate a few pages to the important topic of what to do when things go wrong.



---

# Error Handling

*I knew if I stayed around long enough, something like this would happen.*

—George Bernard Shaw on dying

Error handling in Rust is just different enough to warrant its own short chapter. There aren't any difficult ideas here, just ideas that might be new to you. This chapter covers the two different kinds of error-handling in Rust: `panic` and `Results`.

Ordinary errors are handled using `Results`. These are typically caused by things outside the program, like erroneous input, a network outage, or a permissions problem. That such situations occur is not up to us; even a bug-free program will encounter them from time to time. Most of this chapter is dedicated to that kind of error. We'll cover `panic` first, though, because it's the simpler of the two.

`Panic` is for the other kind of error, the kind that *should never happen*.

## Panic

A program panics when it encounters something so messed up that there must be a bug in the program itself. Something like:

- Out-of-bounds array access
- Integer division by zero
- Calling `.unwrap()` on an `Option` that happens to be `None`
- Assertion failure

(There's also the macro `panic!()`, for cases where your own code discovers that it has gone wrong, and you therefore need to trigger a panic directly. `panic!()` accepts optional `println!()`-style arguments, for building an error message.)

What these conditions have in common is that they are all—not to put too fine a point on it—the programmer’s fault. A good rule of thumb is: “Don’t panic”.

But we all make mistakes. When these errors that shouldn’t happen, do happen—what then? Remarkably, Rust gives you a choice. Rust can either unwind the stack when a panic happens, or abort the process. Unwinding is the default.

## Unwinding

When pirates divvy up the booty from a raid, the captain gets half of the loot. Ordinary crew members earn equal shares of the other half. (Pirates hate fractions, so if either division does not come out even, the result is rounded down, with the remainder going to the ship’s parrot.)

```
fn pirate_share(total: u64, crew_size: usize) -> u64 {  
    let half = total / 2;  
    half / crew_size as u64  
}
```

This may work fine for centuries until one day it transpires that the captain is the sole survivor of a raid. If we pass a `crew_size` of zero to this function, it will divide by zero. In C++, this would be undefined behavior. In Rust, it triggers a panic, which typically proceeds as follows:

- An error message is printed to the terminal:

```
thread 'main' panicked at 'attempt to divide by zero', pirates.rs:3780  
note: Run with `RUST_BACKTRACE=1` for a backtrace.
```

If you set the `RUST_BACKTRACE` environment variable, as the messages suggests, Rust will also dump the stack at this point.

- The stack is unwound. This is a lot like C++ exception handling.

Any temporary values, local variables, or arguments that the current function was using are dropped, in the reverse of the order they were created. Dropping a value simply means cleaning up after it: any `Strings` or `Vecs` the program was using are freed, any open `Files` are closed, and so on. User-defined drop methods are called too; see “[Drop](#)” on page 282. In the particular case of `pirate_share()`, there’s nothing to clean up.

Once the current function call is cleaned up, we move on to its caller, dropping its variables and arguments the same way. Then *that* function’s caller, and so on up the stack.

- Finally, the thread exits. If the panicking thread was the main thread, then the whole process exits (with a nonzero exit code).



Perhaps *panic* is a misleading name for this orderly process. A panic is not a crash. It's not undefined behavior. It's more like a `RuntimeException` in Java or a `std::logic_error` in C++. The behavior is well-defined; it just shouldn't be happening.

Panic is safe. It doesn't violate any of Rust's safety rules; even if you manage to panic in the middle of a standard library method, it will never leave a dangling pointer or a half-initialized value in memory. The idea is that Rust catches the invalid array access, or whatever it is, *before* anything bad happens. It would be unsafe to proceed, so Rust unwinds the stack. But the rest of the process can continue running.

Panic is per thread. One thread can be panicking while other threads are going on about their normal business. In [Chapter 19](#), we'll show how a parent thread can find out when a child thread panics and handle the error gracefully.

There is also a way to *catch* stack unwinding, allowing the thread to survive and continue running. The standard library function `std::panic::catch_unwind()` does this. We won't cover how to use it, but this is the mechanism used by Rust's test harness to recover when an assertion fails in a test. (It can also be necessary when writing Rust code that can be called from C or C++, because unwinding across non-Rust code is undefined behavior; see [Chapter 21](#).)

Ideally, we would all have bug-free code that never panics. But nobody's perfect. You can use threads and `catch_unwind()` to handle panic, making your program more robust. One important caveat is that these tools only catch panics that unwind the stack. Not every panic proceeds this way.

## Aborting

Stack unwinding is the default panic behavior, but there are two circumstances in which Rust does not try to unwind the stack.

If a `.drop()` method triggers a second panic while Rust is still trying to clean up after the first, this is considered fatal. Rust stops unwinding and aborts the whole process.

Also, Rust's panic behavior is customizable. If you compile with `-C panic=abort`, the *first* panic in your program immediately aborts the process. (With this option, Rust does not need to know how to unwind the stack, so this can reduce the size of your compiled code.)

This concludes our discussion of panic in Rust. There is not much to say, because ordinary Rust code has no obligation to handle panic. Even if you do use threads or `catch_unwind()`, all your panic-handling code will likely be concentrated in a few places. It's unreasonable to expect every function in a program to anticipate and cope with bugs in its own code. Errors caused by other factors are another kettle of fish.

# Result

Rust doesn't have exceptions. Instead, functions that can fail have a return type that says so:

```
fn get_weather(location: LatLng) -> Result<WeatherReport, io::Error>
```

The `Result` type indicates possible failure. When we call the `get_weather()` function, it will return either a *success result* `Ok(weather)`, where `weather` is a new `WeatherReport` value, or an *error result* `Err(error_value)`, where `error_value` is an `io::Error` explaining what went wrong.

Rust requires us to write some kind of error handling whenever we call this function. We can't get at the `WeatherReport` without doing *something* to the `Result`, and you'll get a compiler warning if a `Result` value isn't used.

In [Chapter 10](#), we'll see how the standard library defines `Result` and how you can define your own similar types. For now, we'll take a “cookbook” approach and focus on how to use `Results` to get the error-handling behavior you want.

## Catching Errors

The most thorough way of dealing with a `Result` is the way we showed in [Chapter 2](#): use a `match` expression.

```
match get_weather(hometown) {
    Ok(report) => {
        display_weather(hometown, &report);
    }
    Err(err) => {
        println!("error querying the weather: {}", err);
        schedule_weather_retry();
    }
}
```

This is Rust's equivalent of `try/catch` in other languages. It's what you use when you want to handle errors head-on, not pass them on to your caller.

`match` is a bit verbose, so `Result<T, E>` offers a variety of methods that are useful in particular common cases. Each of these methods has a `match` expression in its implementation. (For the full list of `Result` methods, consult the online documentation. The methods listed here are the ones we use the most.)

- `result.is_ok()` and `result.is_err()` return a `bool` telling if `result` is a success result or an error result.

- **result.ok()** returns the success value, if any, as an `Option<T>`. If `result` is a success result, this returns `Some(success_value)`; otherwise, it returns `None`, discarding the error value.
- **result.err()** returns the error value, if any, as an `Option<E>`.
- **result.unwrap\_or(fallback)** returns the success value, if `result` is a success result. Otherwise, it returns `fallback`, discarding the error value.

```
// A fairly safe prediction for Southern California.
const THE_USUAL: WeatherReport = WeatherReport::Sunny(72);

// Get a real weather report, if possible.
// If not, fall back on the usual.
let report = get_weather(los_angeles).unwrap_or(THE_USUAL);
display_weather(los_angeles, &report);
```

This is a nice alternative to `.ok()` because the return type is `T`, not `Option<T>`. Of course, it only works when there's an appropriate fallback value.

- **result.unwrap\_or\_else(fallback\_fn)** is the same, but instead of passing a fallback value directly, you pass a function or closure. This is for cases where it would be wasteful to compute a fallback value if you're not going to use it. The `fallback_fn` is called only if we have an error result.

```
let report =
    get_weather(hometown)
    .unwrap_or_else(|_err| vague_prediction(hometown));
```

(Chapter 14 covers closures in detail.)

- **result.unwrap()** also returns the success value, if `result` is a success result. However, if `result` is an error result, this method panics. This method has its uses; we'll talk more about it later.
- **result.expect(message)** is the same as `.unwrap()`, but lets you provide a message that it prints in case of panic.

Lastly, two methods for borrowing references to the value in a `Result`:

- **result.as\_ref()** converts a `Result<T, E>` to a `Result<&T, &E>`, borrowing a reference to the success or error value in the existing `result`.
- **result.as\_mut()** is the same, but borrows a mutable reference. The return type is `Result<&mut T, &mut E>`.

One reason these last two methods are useful is that all of the other methods listed here, except `.is_ok()` and `.is_err()`, *consume* the `result` they operate on. That is, they take the `self` argument by value. Sometimes it's quite handy to access data inside a result without destroying it, and this is what `.as_ref()` and `.as_mut()` do for us.

For example, suppose you'd like to call `result.ok()`, but you need `result` to be left intact. You can write `result.as_ref().ok()`, which merely borrows `result`, returning an `Option<&T>` rather than an `Option<T>`.

## Result Type Aliases

Sometimes you'll see Rust documentation that seems to omit the error type of a `Result`:

```
fn remove_file(path: &Path) -> Result<()>
```

This means that a `Result` type alias is being used.

A type alias is a kind of shorthand for type names. Modules often define a `Result` type alias to avoid having to repeat an error type that's used consistently by almost every function in the module. For example, the standard library's `std::io` module includes this line of code:

```
pub type Result<T> = result::Result<T, Error>;
```

This defines a public type `std::io::Result<T>`. It's an alias for `Result<T, E>`, but hardcoding `std::io::Error` as the error type. In practical terms, this means that if you write `use std::io;` then Rust will understand `io::Result<String>` as shorthand for `Result<String, io::Error>`.

When something like `Result<()>` appears in the online documentation, you can click on the identifier `Result` to see which type alias is being used and learn the error type. In practice, it's usually obvious from context.

## Printing Errors

Sometimes the only way to handle an error is by dumping it to the terminal and moving on. We already showed one way to do this:

```
println!("error querying the weather: {}", err);
```

The standard library defines several error types with boring names: `std::io::Error`, `std::fmt::Error`, `std::str::Utf8Error`, and so on. All of them implement a common interface, the `std::error::Error` trait, which means they share the following features:

- They're all printable using `println!()`. Printing an error with the `{}` format specifier typically displays only a brief error message. Alternatively, you can print with the `{:?}` format specifier, to get a `Debug` view of the error. This is less user-friendly, but includes extra technical information.

```
// result of `println!("error: {}", err);`  
error: failed to lookup address information: No address associated with
```

```

hostname

// result of `println!("error: {:?}", err);`
error: Error { repr: Custom(Custom { kind: Other, error: StringError(
  "failed to lookup address information: No address associated with
  hostname") }) }

```

- **err.description()** returns an error message as a `&str`.
- **err.cause()** returns an `Option<&Error>`: the underlying error, if any, that triggered `err`.

For example, a networking error might cause a banking transaction to fail, which could in turn cause your boat to be repossessed. If `err.description()` is "boat was repossessed", then `err.cause()` might return an error about the failed transaction; its `.description()` might be "failed to transfer \$300 to United Yacht Supply", and its `.cause()` might be an `io::Error` with details about the specific network outage that caused all the fuss. That third error is the root cause, so its `.cause()` method would return `None`.

Since the standard library only includes rather low-level features, this is usually `None` for standard library errors.

Printing an error value does not also print out its cause. If you want to be sure to print all the available information, use this function:

```

use std::error::Error;
use std::io::{Write, stderr};

/// Dump an error message to `stderr`.
///
/// If another error happens while building the error message or
/// writing to `stderr`, it is ignored.
fn print_error(mut err: &Error) {
    let _ = writeln!(stderr(), "error: {}", err);
    while let Some(cause) = err.cause() {
        let _ = writeln!(stderr(), "caused by: {}", cause);
        err = cause;
    }
}

```

The standard library's error types do not include a stack trace, but the `error-chain` crate makes it easy to define your own custom error type that supports grabbing a stack trace when it's created. It uses the `backtrace` crate to capture the stack.

## Propagating Errors

In most places where we try something that could fail, we don't want to catch and handle the error immediately. It is simply too much code to use a 10-line `match` statement every place where something could go wrong.

Instead, if an error occurs, we usually want to let our caller deal with it. We want errors to *propagate* up the call stack.

Rust has a `?` operator that does this. You can add a `?` to any expression that produces a `Result`, such as the result of a function call:

```
let weather = get_weather(hometown)?;
```

The behavior of `?` depends on whether this function returns a success result or an error result:

- On success, it unwraps the `Result` to get the success value inside. The type of `weather` here is not `Result<WeatherReport, io::Error>` but simply `WeatherReport`.
- On error, it immediately returns from the enclosing function, passing the error result up the call chain. To ensure that this works, `?` can only be used in functions that have a `Result` return type.

There's nothing magical about the `?` operator. You can express the same thing using a `match` expression, although it's much wordier:

```
let weather = match get_weather(hometown) {  
    Ok(success_value) => success_value,  
    Err(err) => return Err(err)  
};
```

The only differences between this and the `?` operator are some fine points involving types and conversions. We'll cover those details in the next section.

In older code, you may see the `try!()` macro, which was the usual way to propagate errors until the `?` operator was introduced in Rust 1.13.

```
let weather = try!(get_weather(hometown));
```

The macro expands to a `match` expression, like the one above.

It's easy to forget just how pervasive the possibility of errors is in a program, particularly in code that interfaces with the operating system. The `?` operator sometimes shows up on almost every line of a function:

```
use std::fs;  
use std::io;  
use std::path::Path;
```

```

fn move_all(src: &Path, dst: &Path) -> io::Result<()> {
    for entry_result in src.read_dir()? { // opening dir could fail
        let entry = entry_result?;      // reading dir could fail
        let dst_file = dst.join(entry.file_name());
        fs::rename(entry.path(), dst_file)?; // renaming could fail
    }
    Ok(()) // phew!
}

```

## Working with Multiple Error Types

Often, more than one thing could go wrong. Suppose we are simply reading numbers from a text file.

```

use std::io::{self, BufRead};

/// Read integers from a text file.
/// The file should have one number on each line.
fn read_numbers(file: &mut BufRead) -> Result<Vec<i64>, io::Error> {
    let mut numbers = vec![];
    for line_result in file.lines() {
        let line = line_result?; // reading lines can fail
        numbers.push(line.parse()?); // parsing integers can fail
    }
    Ok(numbers)
}

```

Rust gives us a compiler error:

```

numbers.push(line.parse()?); // parsing integers can fail
^^^^^^^^^^^^^^^^ the trait `std::convert::From<std::num::ParseIntError>`
is not implemented for `std::io::Error`

```

The terms in this error message will make more sense when we reach [Chapter 11](#), which covers traits. For now, just note that Rust is complaining that it can't convert a `std::num::ParseIntError` value to the type `std::io::Error`.

The problem here is that reading a line from a file and parsing an integer produce two different potential error types. The type of `line_result` is `Result<String, std::io::Error>`. The type of `line.parse()` is `Result<i64, std::num::ParseIntError>`. The return type of our `read_numbers()` function only accommodates `io::Errors`. Rust tries to cope with the `ParseIntError` by converting it to a `io::Error`, but there's no such conversion, so we get a type error.

There are several ways of dealing with this. For example, the `image` crate that we used in [Chapter 2](#) to create image files of the Mandelbrot set defines its own error type, `ImageError`, and implements conversions from `io::Error` and several other error types to `ImageError`. If you'd like to go this route, try the aforementioned `error-chain` crate, which is designed to help you define good error types with just a few lines of code.

A simpler approach is to use what's built into Rust. All of the standard library error types can be converted to the type `Box<std::error::Error>`, which represents “any error.” So an easy way to handle multiple error types is to define these type aliases:

```
type GenError = Box<std::error::Error>;
type GenResult<T> = Result<T, GenError>;
```

Then, change the return type of `read_numbers()` to `GenResult<Vec<i64>>`. With this change, the function compiles. The `?` operator automatically converts either type of error into a `GenError` as needed.

Incidentally, the `?` operator does this automatic conversion using a standard method that you can use yourself. To convert any error to the `GenError` type, call `GenError::from()`:

```
let io_error = io::Error::new(           // make our own io::Error
    io::ErrorKind::Other, "timed out");
return Err(GenError::from(io_error)); // manually convert to GenError
```

We'll cover the `From` trait and its `from()` method fully in [Chapter 13](#).

The downside of the `GenError` approach is that the return type no longer communicates precisely what kinds of errors the caller can expect. The caller must be ready for anything.

If you're calling a function that returns a `GenResult`, and you want to handle one particular kind of error, but let all others propagate out, use the generic method `error.downcast_ref:::<ErrorType>()`. It borrows a reference to the error, *if* it happens to be the particular type of error you're looking for:

```
loop {
    match compile_project() {
        Ok(()) => return Ok(()),
        Err(err) => {
            if let Some(mse) = err.downcast_ref:::<MissingSemicolonError>() {
                insert_semicolon_in_source_code(mse.file(), mse.line())?;
                continue; // try again!
            }
            return Err(err);
        }
    }
}
```

Many languages have built-in syntax to do this, but it turns out to be rarely needed. Rust has a method for it instead.



## Dealing with Errors That “Can’t Happen”

Sometimes we just *know* that an error can’t happen. For example, suppose we’re writing code to parse a configuration file, and at one point we find that the next thing in the file is a string of digits:

```
if next_char.is_digit(10) {
    let start = current_index;
    current_index = skip_digits(&line, current_index);
    let digits = &line[start..current_index];
    ...
}
```

We want to convert this string of digits to an actual number. There’s a standard method that does this:

```
let num = digits.parse::<u64>();
```

Now the problem: the `str.parse::<u64>()` method doesn’t return a `u64`. It returns a `Result`. It can fail, because some strings aren’t numeric.

```
"bleen".parse::<u64>() // ParseIntError: invalid digit
```

But we happen to know that in this case, `digits` consists entirely of digits. What should we do?

If the code we’re writing already returns a `GenResult`, we can tack on a `?` and forget about it. Otherwise, we face the irritating prospect of having to write error-handling code for an error that can’t happen. The best choice then would be to use `.unwrap()`, a `Result` method we mentioned earlier.

```
let num = digits.parse::<u64>().unwrap();
```

This is just like `?` except that if we’re wrong about this error, if it *can* happen, then in that case we would panic.

In fact, we are wrong about this particular case. If the input contains a long enough string of digits, the number will be too big to fit in a `u64`.

```
"99999999999999999999999999999999".parse::<u64>() // overflow error
```

Using `.unwrap()` in this particular case would therefore be a bug. Bogus input shouldn’t cause a panic.

That said, situations do come up where a `Result` value truly can’t be an error. For example, in [Chapter 18](#), you’ll see that the `Write` trait defines a common set of methods (`.write()` and others) for text and binary output. All of those methods return `io::Results`, but if you happen to be writing to a `Vec<u8>`, they can’t fail. In such cases, it’s acceptable to use `.unwrap()` or `.expect(message)` to dispense with the `Results`.

These methods are also useful when an error would indicate a condition so severe or bizarre that panic is exactly how you want to handle it.

```
fn print_file_age(filename: &Path, last_modified: SystemTime) {
    let age = last_modified.elapsed().expect("system clock drift");
    ...
}
```

Here, the `.elapsed()` method can fail only if the system time is *earlier* than when the file was created. This can happen if the file was created recently, and the system clock was adjusted backward while our program was running. Depending on how this code is used, it's a reasonable judgment call to panic in that case, rather than handle the error or propagate it to the caller.

## Ignoring Errors

Occasionally we just want to ignore an error altogether. For example, in our `print_error()` function, we had to handle the unlikely situation where printing the error triggers another error. This could happen, for example, if `stderr` is piped to another process, and that process is killed. As there's not much we can do about this kind of error, we just want to ignore it; but the Rust compiler warns about unused `Result` values:

```
writeln!(stderr(), "error: {}", err); // warning: unused result
```

The idiom `let _ = ...` is used to silence this warning:

```
let _ = writeln!(stderr(), "error: {}", err); // ok, ignore result
```

## Handling Errors in `main()`

In most places where a `Result` is produced, letting the error bubble up to the caller is the right behavior. This is why `?` is a single character in Rust. As we've seen, in some programs it's used on many lines of code in a row.

But if you propagate an error long enough, eventually it reaches `main()`, and that's where this approach has to stop. `main()` can't use `?` because its return type is not `Result`.

```
fn main() {
    calculate_tides()?; // error: can't pass the buck any further
}
```

The simplest way to handle errors in `main()` is to use `.expect()`.

```
fn main() {
    calculate_tides().expect("error"); // the buck stops here
}
```

If `calculate_tides()` returns an error result, the `.expect()` method panics. Panicking in the main thread prints an error message, then exits with a nonzero exit code, which is roughly the desired behavior. We use this all the time for tiny programs. It's a start.

The error message is a little intimidating, though:

```
$ tidecalc --planet mercury
thread 'main' panicked at 'error: "moon not found"', /buildslave/rust-buildbot/s
lave/nightly-dist-rustc-linux/build/src/libcore/result.rs:837
note: Run with `RUST_BACKTRACE=1` for a backtrace.
```

The error message is lost in the noise. Also, `RUST_BACKTRACE=1` is bad advice in this particular case. It helps to print the error message yourself:

```
fn main() {
    if let Err(err) = calculate_tides() {
        print_error(&err);
        std::process::exit(1);
    }
}
```

This code uses an `if let` expression to print the error message only if the call to `calculate_tides()` returns an error result. For details about `if let` expressions, see [Chapter 10](#). The `print_error` function is listed in [“Printing Errors” on page 150](#).

Now the output is nice and tidy:

```
$ tidecalc --planet mercury
error: moon not found
```

## Declaring a Custom Error Type

Suppose you are writing a new JSON parser, and you want it to have its own error type. (We haven't covered user-defined types yet; that's coming up in a few chapters. But error types are handy, so we'll include a bit of a sneak preview here.)

Approximately the minimum code you would write is:

```
// json/src/error.rs

#[derive(Debug, Clone)]
pub struct JsonError {
    pub message: String,
    pub line: usize,
    pub column: usize,
}
```

This struct will be called `json::error::JsonError`, and when you want to raise an error of this type, you can write:

```
return Err(JsonError {
    message: "expected ']' at end of array".to_string(),
    line: current_line,
    column: current_column
});
```

This will work fine. However, if you want your error type to work like the standard error types, as your library's users will expect, then you have a bit more work to do:

```
use std;
use std::fmt;

// Errors should be printable.
impl fmt::Display for JsonError {
    fn fmt(&self, f: &mut fmt::Formatter) -> Result<(), fmt::Error> {
        write!(f, "{} ({}:{})", self.message, self.line, self.column)
    }
}

// Errors should implement the std::error::Error trait.
impl std::error::Error for JsonError {
    fn description(&self) -> &str {
        &self.message
    }
}
```

Again, the meaning of the `impl` keyword, `self`, and all the rest will be explained in the next few chapters.

## Why Results?

Now we know enough to understand what Rust is getting at by choosing `Results` over exceptions. Here are the key points of the design:

- Rust requires the programmer to make some sort of decision, and record it in the code, at every point where an error could occur. This is good because otherwise, it's easy to get error handling wrong through neglect.
- The most common decision is to allow errors to propagate, and that's written with a single character, `'?'`. Thus error plumbing does not clutter up your code the way it does in C and Go. Yet it's still visible: you can look at a chunk of code and see at a glance all places where errors are propagated.
- Since the possibility of errors is part of every function's return type, it's clear which functions can fail and which can't. If you change a function to be fallible, you're changing its return type, so the compiler will make you update that function's downstream users.

- Rust checks that `Result` values are used, so you can't accidentally let an error pass silently (a common mistake in C).
- Since `Result` is a data type like any other, it's easy to store success and error results in the same collection. This makes it easy to model partial success. For example, if you're writing a program that loads millions of records from a text file, and you need a way to cope with the likely outcome that most will succeed, but some will fail, you can represent that situation in memory using a vector of `Results`.

The cost is that you'll find yourself thinking about and engineering error handling more in Rust than you would in other languages. As in many other areas, Rust's take on error handling is wound just a little tighter than what you're used to. For systems programming, it's worth it.



---

# Crates and Modules

*This is one note in a Rust theme: systems programmers can have nice things.*

—Robert O’Callahan, “[Random Thoughts on Rust: Crates.io and IDEs](#)”

Suppose you’re writing a program that simulates the growth of ferns, from the level of individual cells on up. Your program, like a fern, will start out very simple, with all the code, perhaps, in a single file—just the spore of an idea. As it grows, it will start to have internal structure. Different pieces will have different purposes. It will branch out into multiple files. It may cover a whole directory tree. In time it may become a significant part of a whole software ecosystem.

This chapter covers the features of Rust that help keep your program organized: crates and modules. We’ll also cover a wide range of topics that come up naturally as your project grows, including how to document and test Rust code, how to silence unwanted compiler warnings, how to use Cargo to manage project dependencies and versioning, how to publish open source libraries on crates.io, and more.

## Crates

Rust programs are made of *crates*. Each crate is a Rust project: all the source code for a single library or executable, plus any associated tests, examples, tools, configuration, and other junk. For your fern simulator, you might use third-party libraries for 3D graphics, bioinformatics, parallel computation, and so on. These libraries are distributed as crates (see [Figure 8-1](#)).

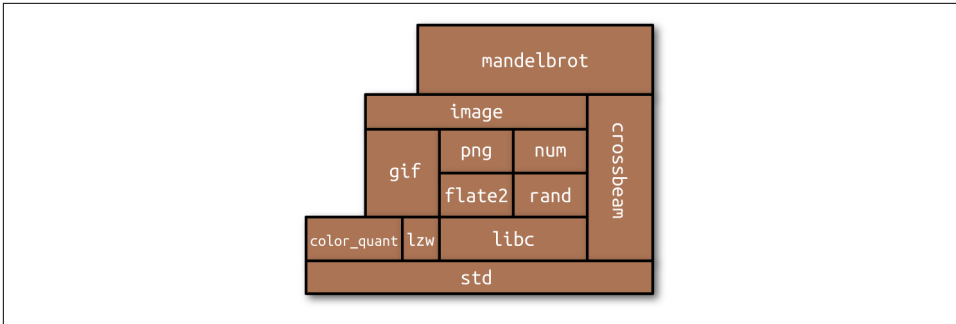

Figure 8-1. A crate and its dependencies

The easiest way to see what crates are and how they work together is to use cargo build with the `--verbose` flag to build an existing project that has some dependencies. We did this, using “[A Concurrent Mandelbrot Program](#)” on page 35 as our example. The results are shown here:

```

$ cd mandelbrot
$ cargo clean # delete previously compiled code
$ cargo build --verbose
  Updating registry `https://github.com/rust-lang/crates.io-index`
  Downloading image v0.6.1
  Downloading crossbeam v0.2.9
  Downloading gif v0.7.0
  Downloading png v0.4.2

... (downloading and compiling many more crates)

  Compiling png v0.4.2
    Running `rustc ../png-0.4.2/src/lib.rs
      --crate-name png
      --crate-type lib
      --extern num=../libnum-a2e6e61627ca7fe5.rlib
      --extern inflate=../libinflate-331fc425bf167339.rlib
      --extern flate2=../libflate2-857dff75f2932d8a.rlib
      ...`
  Compiling image v0.6.1
    Running `rustc ../image-0.6.1/./src/lib.rs
      --crate-name image
      --crate-type lib
      --extern png=../libpng-16c24f58491a5853.rlib
      ...`
  Compiling mandelbrot v0.1.0 (file:///.../mandelbrot)
    Running `rustc src/main.rs
      --crate-name mandelbrot
      --crate-type bin
      --extern crossbeam=../libcrossbeam-ba292320058da7df.rlib
      --extern image=../libimage-254ec48c8f0684f2.rlib
  
```



\$

We reformatted the `rustc` command lines for readability, and we deleted a lot of compiler options that aren't relevant to our discussion, replacing them with an ellipsis (...).

You might recall that by the time we were done, the Mandelbrot program's `main.rs` contained three `extern crate` declarations:

```
extern crate num;
extern crate image;
extern crate crossbeam;
```

These lines simply tell Rust that `num`, `image`, and `crossbeam` are external libraries, not part of the Mandelbrot program itself.

We also specified in our `Cargo.toml` file which version of each crate we wanted:

```
[dependencies]
num = "0.1.27"
image = "0.6.1"
crossbeam = "0.2.8"
```

The word *dependencies* here just means other crates this project uses: code we're depending on. We found these crates on [crates.io](https://crates.io), the Rust community's site for open source crates. For example, we found out about the `image` library by going to [crates.io](https://crates.io) and searching for an `image` library. Each crate's page on [crates.io](https://crates.io) provides links to documentation and source code, as well as a line of configuration like `image = "0.6.1"` that you can copy and add to your `Cargo.toml`. The version numbers shown here are simply the latest versions of these three packages at the time we wrote the program.

The Cargo transcript tells the story of how this information is used. When we run `cargo build`, Cargo starts by downloading source code for the specified versions of these crates from [crates.io](https://crates.io). Then, it reads those crates' `Cargo.toml` files, downloads *their* dependencies, and so on recursively. For example, the source code for version 0.6.1 of the `image` crate contains a `Cargo.toml` file that includes this:

```
[dependencies]
byteorder = "0.4.0"
num = "0.1.27"
enum_primitive = "0.1.0"
glob = "0.2.10"
```

Seeing this, Cargo knows that before it can use `image`, it must fetch these crates as well. Later on, we'll see how to tell Cargo to fetch source code from a Git repository or the local filesystem rather than [crates.io](https://crates.io).

Once it has obtained all the source code, Cargo compiles all the crates. It runs `rustc`, the Rust compiler, once for each crate in the project's dependency graph. When compiling libraries, Cargo uses the `--crate-type lib` option. This tells `rustc` not to look for a `main()` function but instead to produce an `.rlib` file containing compiled code in a form that later `rustc` commands can use as input. When compiling a program, Cargo uses `--crate-type bin`, and the result is a binary executable for the target platform: `mandelbrot.exe` on Windows, for example.

With each `rustc` command, Cargo passes `--extern` options giving the filename of each library the crate will use. That way, when `rustc` sees a line of code like `extern crate crossbeam;`, it knows where to find that compiled crate on disk. The Rust compiler needs access to these `.rlib` files because they contain the compiled code of the library. Rust will statically link that code into the final executable. The `.rlib` also contains type information, so Rust can check that the library features we're using in our code actually exist in the crate, and that we're using them correctly. It also contains a copy of the crate's public inline functions, generics, and macros, features that can't be fully compiled to machine code until Rust sees how we use them.

`cargo build` supports all sorts of options, most of which are beyond the scope of this book, but we will mention one here: `cargo build --release` produces an optimized build. Release builds run faster, but they take longer to compile, they don't check for integer overflow, they skip `debug_assert!()` assertions, and the stack traces they generate on panic are generally less reliable.

## Build Profiles

There are several configuration settings you can put in your `Cargo.toml` file that affect the `rustc` command lines that cargo generates.

Command line	Cargo.toml section used
<code>cargo build</code>	<code>[profile.debug]</code>
<code>cargo build --release</code>	<code>[profile.release]</code>
<code>cargo test</code>	<code>[profile.test]</code>

The defaults are usually fine, but one exception we've found is when you want to use a profiler—a tool that measures where your program is spending its CPU time. To get the best data from a profiler, you need both optimizations (usually enabled only in release builds) and debug symbols (usually enabled only in debug builds). To enable both, add this to your `Cargo.toml`:

```
[profile.release]
debug = true # enable debug symbols in release builds
```

The debug setting controls the `-g` option to `rustc`. With this configuration, when you type `cargo build --release`, you'll get a binary with debug symbols. The optimization settings are unaffected.

The [Cargo documentation](#) lists many other settings you can adjust.

## Modules

*Modules* are Rust's namespaces. They're containers for the functions, types, constants, and so on that make up your Rust program or library. Whereas crates are about code sharing between projects, modules are about code organization *within* a project. They look like this:

```
mod spores {
    use cells::Cell;

    /// A cell made by an adult fern. It disperses on the wind as part of
    /// the fern life cycle. A spore grows into a prothallus -- a whole
    /// separate organism, up to 5mm across -- which produces the zygote
    /// that grows into a new fern. (Plant sex is complicated.)
    pub struct Spore {
        ...
    }

    /// Simulate the production of a spore by meiosis.
    pub fn produce_spore(factory: &mut Sporangium) -> Spore {
        ...
    }

    /// Mix genes to prepare for meiosis (part of interphase).
    fn recombine(parent: &mut Cell) {
        ...
    }
    ...
}
```

A module is a collection of *items*, named features like the `Spore` struct and the two functions in this example. The `pub` keyword makes an item public, so it can be accessed from outside the module. Anything that isn't marked `pub` is private.

```
let s = spores::produce_spore(&mut factory); // ok

spores::recombine(&mut cell); // error: `recombine` is private
```

Modules can nest, and it's fairly common to see a module that's just a collection of submodules:

```
mod plant_structures {
    pub mod roots {
        ...
    }
}
```

```

    }
    pub mod stems {
        ...
    }
    pub mod leaves {
        ...
    }
}

```

In this way, we could write out a whole program, with a huge amount of code and a whole hierarchy of modules, all in a single source file. Actually working that way is a pain, though, so there's an alternative.

## Modules in Separate Files

A module can also be written like this:

```
mod spores;
```

Earlier, we included the body of the `spores` module, wrapped in curly braces. Here, we're instead telling the Rust compiler that the `spores` module lives in a separate file, called `spores.rs`:

```

// spores.rs

/// A cell made by an adult fern...
pub struct Spore {
    ...
}

/// Simulate the production of a spore by meiosis.
pub fn produce_spore(factory: &mut Sporangium) -> Spore {
    ...
}

/// Mix genes to prepare for meiosis (part of interphase).
fn recombine(parent: &mut Cell) {
    ...
}

```

`spores.rs` contains only the items that make up the module. It doesn't need any kind of boilerplate to declare that it's a module.

The location of the code is the *only* difference between this `spores` module and the version we showed in the previous section. The rules about what's public and what's private are exactly the same either way. And Rust never compiles modules separately, even if they're in separate files: when you build a Rust crate, you're recompiling all of its modules.

A module can have its own directory. When Rust sees `mod spores;`, it checks for both `spores.rs` and `spores/mod.rs`; if neither file exists, or both exist, that's an error. For

this example, we used *spores.rs*, because the *spores* module did not have any sub-modules. But consider the *plant\_structures* module we wrote out earlier. If we decide to split that module and its three submodules into their own files, the resulting project would look like this:

```
fern_sim/
├── Cargo.toml
└── src/
    ├── main.rs
    ├── spores.rs
    └── plant_structures/
        ├── mod.rs
        ├── leaves.rs
        ├── roots.rs
        └── stems.rs
```

In *main.rs*, we declare the *plant\_structures* module:

```
pub mod plant_structures;
```

This causes Rust to load *plant\_structures/mod.rs*, which declares the three submodules:

```
// in plant_structures/mod.rs
pub mod roots;
pub mod stems;
pub mod leaves;
```

The content of those three modules is stored in separate files named *leaves.rs*, *roots.rs*, and *stems.rs*, located alongside *mod.rs* in the *plant\_structures* directory.

## Paths and Imports

The `::` operator is used to access features of a module. Code anywhere in your project can refer to any standard library feature by writing out its *absolute path*:

```
if s1 > s2 {
    ::std::mem::swap(&mut s1, &mut s2);
}
```

This function name, `::std::mem::swap`, is an absolute path, because it starts with a double colon. The path `::std` refers to the top-level module of the standard library. `::std::mem` is a submodule within the standard library, and `::std::mem::swap` is a public function in that module.

You could write all your code this way, spelling out `::std::f64::consts::PI` and `::std::collections::HashMap::new` every time you want a circle or a dictionary, but it would be tedious to type and hard to read. The alternative is to *import* features into the modules where they're used:

```

use std::mem;

if s1 > s2 {
    mem::swap(&mut s1, &mut s2);
}

```

The `use` declaration causes the name `mem` to be a local alias for `::std::mem` throughout the enclosing block or module. Paths in `use` declarations are automatically absolute paths, so there is no need for a leading `::`.

We could write `use std::mem::swap;` to import the `swap` function itself instead of the `mem` module. However, what we did above is generally considered the best style: import types, traits, and modules (like `std::mem`), then use relative paths to access the functions, constants, and other members within.

Several names can be imported at once:

```

use std::collections::{HashMap, HashSet}; // import both

use std::io::prelude::*; // import everything

```

This is just shorthand for writing out all the individual imports:

```

use std::collections::HashMap;
use std::collections::HashSet;

// all the public items in std::io::prelude:
use std::io::prelude::Read;
use std::io::prelude::Write;
use std::io::prelude::BufRead;
use std::io::prelude::Seek;

```

Modules do *not* automatically inherit names from their parent modules. For example, suppose we have this in our `proteins/mod.rs`:

```

// proteins/mod.rs
pub enum AminoAcid { ... }
pub mod synthesis;

```

Then the code in `synthesis.rs` does not automatically see the type `AminoAcid`:

```

// proteins/synthesis.rs
pub fn synthesize(seq: &[AminoAcid]) // error: can't find type `AminoAcid`
...

```

Instead, each module starts with a blank slate and must import the names it uses:

```

// proteins/synthesis.rs
use super::AminoAcid; // explicitly import from parent

pub fn synthesize(seq: &[AminoAcid]) // ok
...

```

The keyword `super` has a special meaning in imports: it's an alias for the parent module. Similarly, `self` is an alias for the current module.

```
// in proteins/mod.rs

// import from a submodule
use self::synthesis::synthesize;

// import names from an enum,
// so we can write `Lys` for lysine, rather than `AminoAcid::Lys`
use self::AminoAcid::*;
```

While paths in imports are treated as absolute paths by default, `self` and `super` let you override that and import from relative paths.

(The `AminoAcid` example here is, of course, a departure from the style rule we mentioned earlier about only importing types, traits, and modules. If our program includes long amino acid sequences, this is justified under Orwell's Sixth Rule: "Break any of these rules sooner than say anything outright barbarous.")

Submodules can access private items in their parent modules, but they have to import each one by name. `use super::*;` only imports items that are marked `pub`.

Modules aren't the same thing as files, but there is a natural analogy between modules and the files and directories of a Unix filesystem. The `use` keyword creates aliases, just as the `ln` command creates links. Paths, like filenames, come in absolute and relative forms. `self` and `super` are like the `.` and `..` special directories. And `extern crate` grafts another crate's root module into your project. It is a lot like mounting a filesystem.

## The Standard Prelude

We said a moment ago that each module starts with a "blank slate," as far as imported names are concerned. But the slate is not *completely* blank.

For one thing, the standard library `std` is automatically linked with every project. It's as though your `lib.rs` or `main.rs` contained an invisible declaration for it:

```
extern crate std;
```

Furthermore, a few particularly handy names, like `Vec` and `Result`, are included in the *standard prelude* and automatically imported. Rust behaves as though every module, including the root module, started with the following import:

```
use std::prelude::v1::*;
```

The standard prelude contains a few dozen commonly used traits and types. It does *not* contain `std`. So if your module refers to `std`, you'll have to import it explicitly, like this:

```
use std;
```

Usually, it makes more sense to import the particular feature of `std` that you're using.

In [Chapter 2](#), we mentioned that libraries sometimes provide modules named `prelude`. But `std::prelude::v1` is the only prelude that is ever imported automatically. Naming a module `prelude` is just a convention that tells users it's meant to be imported using `*`.

## Items, the Building Blocks of Rust

A module is made up of *items*. There are several kinds of item, and the list is really a list of the language's major features:

### *Functions*

We have seen a great many of these already.

### *Types*

User-defined types are introduced using the `struct`, `enum`, and `trait` keywords. We'll dedicate a chapter to each of them, in good time; a simple struct looks like this:

```
pub struct Fern {  
    pub roots: RootSet,  
    pub stems: StemSet  
}
```

A struct's fields, even private fields, are accessible throughout the module where the struct is declared. Outside the module, only public fields are accessible.

It turns out that enforcing access control by module, rather than by class as in Java or C++, is surprisingly helpful for software design. It cuts down on boilerplate “getter” and “setter” methods, and it largely eliminates the need for anything like C++ `friend` declarations. A single module can define several types that work closely together, such as perhaps `frond::LeafMap` and `frond::LeafMapIter`, accessing each other's private fields as needed, while still hiding those implementation details from the rest of your program.

### *Type aliases*

As we've seen, the `type` keyword can be used like `typedef` in C++, to declare a new name for an existing type:

```
type Table = HashMap<String, Vec<String>>;
```

The type `Table` that we're declaring here is shorthand for this particular kind of `HashMap`.



```
fn show(table: &Table) {  
    ...  
}
```

### impl blocks

Methods are attached to types using `impl` blocks:

```
impl Cell {  
    pub fn distance_from_origin(&self) -> f64 {  
        f64::hypot(self.x, self.y)  
    }  
}
```

The syntax is explained in [Chapter 9](#). An `impl` block can't be marked `pub`. Instead, individual methods are marked `pub` to make them visible outside the current module.

Private methods, like private struct fields, are visible throughout the module where they're declared.

### Constants

The `const` keyword introduces a constant. The syntax is just like `let` except that it may be marked `pub`, and the type is required. Also, `UPPERCASE_NAMES` are conventional for constants:

```
pub const ROOM_TEMPERATURE: f64 = 20.0; // degrees Celsius
```

The `static` keyword introduces a static item, which is nearly the same thing:

```
pub static ROOM_TEMPERATURE: f64 = 68.0; // degrees Fahrenheit
```

A constant is a bit like a C++ `#define`: the value is compiled into your code every place it's used. A static is a variable that's set up before your program starts running and lasts until it exits. Use constants for magic numbers and strings in your code. Use statics for larger amounts of data, or any time you'll need to borrow a reference to the constant value.

There are no `mut` constants. Statics can be marked `mut`, but as discussed in [Chapter 5](#), Rust has no way to enforce its rules about exclusive access on `mut` statics. They are, therefore, inherently non-thread-safe, and safe code can't use them at all:

```
static mut PACKETS_SERVED: usize = 0;  
  
println!("{}", PACKETS_SERVED); // error: use of mutable static
```

Rust discourages global mutable state. For a discussion of the alternatives, see [“Global Variables” on page 496](#).

## Modules

We've already talked about these quite a bit. As we've seen, a module can contain submodules, which can be public or private, like any other named item.

## Imports

`use` and `extern crate` declarations are items too. Even though they're just aliases, they can be public:

```
// in plant_structures/mod.rs
...
pub use self::leaves::Leaf;
pub use self::roots::Root;
```

This means that `Leaf` and `Root` are public items of the `plant_structures` module. They're still simple aliases for `plant_structures::leaves::Leaf` and `plant_structures::roots::Root`.

The standard prelude is written as just such a series of `pub` imports.

## `extern blocks`

These declare a collection of functions written in some other language (typically C or C++), so that your Rust code can call them. We'll cover `extern` blocks in [Chapter 21](#).

Rust warns about items that are declared, but never used:

```
warning: function is never used: `is_square`
--> src/crates_unused_items.rs:23:9
   |
23 | /           pub fn is_square(root: &Root) -> bool {
24 | |           root.cross_section_shape().is_square()
25 | |           }
   | |_____^
```

This warning can be puzzling, because there are two very different possible causes. Perhaps this function really is dead code at the moment. Or, maybe you meant to use it in other crates. In that case, you need to mark it *and all enclosing modules* as public.

## Turning a Program into a Library

As your fern simulator starts to take off, you decide you need more than a single program. Suppose you've got one command-line program that runs the simulation and saves results in a file. Now, you want to write other programs for performing scientific analysis of the saved results, displaying 3D renderings of the growing plants in real time, rendering photorealistic pictures, and so on. All these programs need to share the basic fern simulation code. You need to make a library.

The first step is to factor your existing project into two parts: a library crate, which contains all the shared code, and an executable, which contains the code that's only needed for your existing command-line program.

To show how you can do this, let's use a grossly simplified example program:

```
struct Fern {
    size: f64,
    growth_rate: f64
}

impl Fern {
    /// Simulate a fern growing for one day.
    fn grow(&mut self) {
        self.size *= 1.0 + self.growth_rate;
    }
}

/// Run a fern simulation for some number of days.
fn run_simulation(fern: &mut Fern, days: usize) {
    for _ in 0 .. days {
        fern.grow();
    }
}

fn main() {
    let mut fern = Fern {
        size: 1.0,
        growth_rate: 0.001
    };
    run_simulation(&mut fern, 1000);
    println!("final fern size: {}", fern.size);
}
```

We'll assume that this program has a trivial *Cargo.toml* file:

```
[package]
name = "fern_sim"
version = "0.1.0"
authors = ["You <you@example.com>"]
```

Turning this program into a library is easy. Here are the steps:

1. Rename the file *src/main.rs* to *src/lib.rs*.
2. Add the `pub` keyword to items in *src/lib.rs* that will be public features of our library.
3. Move the `main` function to a temporary file somewhere. We'll come back to it in a minute.

The resulting *src/lib.rs* file looks like this:

```

pub struct Fern {
    pub size: f64,
    pub growth_rate: f64
}

impl Fern {
    /// Simulate a fern growing for one day.
    pub fn grow(&mut self) {
        self.size *= 1.0 + self.growth_rate;
    }
}

/// Run a fern simulation for some number of days.
pub fn run_simulation(fern: &mut Fern, days: usize) {
    for _ in 0 .. days {
        fern.grow();
    }
}

```

Note that we didn't need to change anything in *Cargo.toml*. This is because our minimal *Cargo.toml* file leaves Cargo to its default behavior. By default, `cargo build` looks at the files in our source directory and figures out what to build. When it sees the file *src/lib.rs*, it knows to build a library.

The code in *src/lib.rs* forms the *root module* of the library. Other crates that use our library can only access the public items of this root module.

## The *src/bin* Directory

Getting the original command-line `fern_sim` program working again is also straightforward: Cargo has some built-in support for small programs that live in the same codebase as a library.

In fact, Cargo itself is written this way. The bulk of the code is in a Rust library. The `cargo` command-line program that we've been using throughout this book is a thin wrapper program that calls out to the library for all the heavy lifting. Both the library and the command-line program **live in the same source repository**.

We can put our program and our library in the same codebase, too. Put this code into a file named *src/bin/efern.rs*:

```

extern crate fern_sim;
use fern_sim::{Fern, run_simulation};

fn main() {
    let mut fern = Fern {
        size: 1.0,
        growth_rate: 0.001
    };
    run_simulation(&mut fern, 1000);
}

```

```

    println!("final fern size: {}", fern.size);
}

```

The `main` function is the one we set aside earlier. We've added an `extern crate` declaration, since this program will use the `fern_sim` library crate, and we're importing `Fern` and `run_simulation` from the library.

Because we've put this file into `src/bin`, Cargo will compile both the `fern_sim` library and this program the next time we run `cargo build`. We can run the `efern` program using `cargo run --bin efern`. Here's what it looks like, using `--verbose` to show the commands Cargo is running:

```

$ cargo build --verbose
  Compiling fern_sim v0.1.0 (file:///.../fern_sim)
    Running `rustc src/lib.rs --crate-name fern_sim --crate-type lib ...`
    Running `rustc src/bin/efern.rs --crate-name efern --crate-type bin ...`
$ cargo run --bin efern --verbose
  Fresh fern_sim v0.1.0 (file:///.../fern_sim)
    Running `target/debug/efern`
final fern size: 2.7169239322355985

```

We still didn't have to make any changes to `Cargo.toml`, because again, Cargo's default is to look at your source files and figure things out. It automatically treats `.rs` files in `src/bin` as extra programs to build.

Of course, now that `fern_sim` is a library, we also have another option. We could have put this program in its own isolated project, in a completely separate directory, with its own `Cargo.toml` listing `fern_sim` as a dependency:

```

[dependencies]
fern_sim = { path = "../fern_sim" }

```

Perhaps that is what you'll do for other fern-simulating programs down the road. The `src/bin` directory is just right for a simple program like `efern`.

## Attributes

Any item in a Rust program can be decorated with *attributes*. Attributes are Rust's catch-all syntax for writing miscellaneous instructions and advice to the compiler. For example, suppose you're getting this warning:

```

libgit2.rs: warning: type `git_revspec` should have a camel case name
such as `GitRevspec`, #[warn(non_camel_case_types)] on by default

```

But you chose this name for a reason, and you wish Rust would shut up about it. You can disable the warning by adding an `#[allow]` attribute on the type:

```

#[allow(non_camel_case_types)]
pub struct git_revspec {

```

```
} ...
```

Conditional compilation is another feature that's written using an attribute, the `#[cfg]` attribute:

```
// Only include this module in the project if we're building for Android.
#[cfg(target_os = "android")]
mod mobile;
```

The full syntax of `#[cfg]` is specified in the [Rust Reference](#); the most commonly used options are listed here:

<code>#[cfg(...)]</code> option	Enabled when
<code>test</code>	Tests are enabled (compiling with <code>cargo test</code> or <code>rustc --test</code> ).
<code>debug_assertions</code>	Debug assertions are enabled (typically in nonoptimized builds).
<code>unix</code>	Compiling for Unix, including macOS.
<code>windows</code>	Compiling for Windows.
<code>target_pointer_width = "64"</code>	Targeting a 64-bit platform. The other possible value is "32".
<code>target_arch = "x86_64"</code>	Targeting x86-64 in particular. Other values: "x86", "arm", "aarch64", "powerpc", "powerpc64", "mips".
<code>target_os = "macos"</code>	Compiling for macOS. Other values: "windows", "ios", "android", "linux", "openbsd", "netbsd", "dragonfly", "bitrig".
<code>feature = "robots"</code>	The user-defined feature named "robots" is enabled (compiling with <code>cargo build --feature robots</code> or <code>rustc --cfg feature='\"robots\"'</code> ). Features are declared in the <a href="#">[features] section of Cargo.toml</a> .
<code>not(A)</code>	<i>A</i> is not satisfied. To provide two different implementations of a function, mark one with <code>#[cfg(X)]</code> and the other with <code>#[cfg(not(X))]</code> .
<code>all(A,B)</code>	Both <i>A</i> and <i>B</i> are satisfied (the equivalent of <code>&amp;&amp;</code> ).
<code>any(A,B)</code>	Either <i>A</i> or <i>B</i> is satisfied (the equivalent of <code>  </code> ).

Occasionally, we need to micromanage the inline expansion of functions, an optimization that we're usually happy to leave to the compiler. We can use the `#[inline]` attribute for that:

```
/// Adjust levels of ions etc. in two adjacent cells
/// due to osmosis between them.
#[inline]
fn do_osmosis(c1: &mut Cell, c2: &mut Cell) {
```

```
} ...
```

There's one situation where inlining *won't* happen without `#[inline]`. When a function or method defined in one crate is called in another crate, Rust won't inline it unless it's generic (it has type parameters) or it's explicitly marked `#[inline]`.

Otherwise, the compiler treats `#[inline]` as a suggestion. Rust also supports the more insistent `#[inline(always)]`, to request that a function be expanded inline at every call site, and `#[inline(never)]`, to ask that a function never be inlined.

Some attributes, like `#[cfg]` and `#[allow]`, can be attached to a whole module and apply to everything in it. Others, like `#[test]` and `#[inline]`, must be attached to individual items. As you might expect for a catch-all feature, each attribute is custom-made and has its own set of supported arguments. The Rust Reference documents [the full set of supported attributes](#) in detail.

To attach an attribute to a whole crate, add it at the top of the `main.rs` or `lib.rs` file, before any items, and write `#!` instead of `#`, like this:

```
// libgit2_sys/lib.rs
#![allow(non_camel_case_types)]

pub struct git_revspec {
    ...
}

pub struct git_error {
    ...
}
```

The `#!` tells Rust to attach an attribute to the enclosing item rather than whatever comes next: in this case, the `#![allow]` attribute attaches to the whole `libgit2_sys` crate, not just `struct git_revspec`.

`#!` can also be used inside functions, structs, and so on, but it's only typically used at the beginning of a file, to attach an attribute to the whole module or crate. Some attributes always use the `#!` syntax because they can only be applied to a whole crate.

For example, the `#![feature]` attribute is used to turn on *unstable* features of the Rust language and libraries, features that are experimental, and therefore might have bugs or might be changed or removed in the future. For instance, as we're writing this, Rust has experimental support for 128-bit integer types `i128` and `u128`; but since these types are experimental, you can only use them by (1) installing the Nightly version of Rust and (2) explicitly declaring that your crate uses them:

```
#![feature(i128_type)]

fn main() {
```

```

    // Do my math homework, Rust!
    println!("{}", 9204093811595833589_u128 * 19973810893143440503_u128);
}

```

Over time, the Rust team sometimes *stabilizes* an experimental feature, so that it becomes a standard part of the language. The `#![feature]` attribute then becomes superfluous, and Rust generates a warning advising you to remove it.

## Tests and Documentation

As we saw in “Writing and Running Unit Tests” on page 11, a simple unit testing framework is built into Rust. Tests are ordinary functions marked with the `#[test]` attribute.

```

#[test]
fn math_works() {
    let x: i32 = 1;
    assert!(x.is_positive());
    assert_eq!(x + 1, 2);
}

```

`cargo test` runs all the tests in your project.

```

$ cargo test
   Compiling math_test v0.1.0 (file:///.../math_test)
   Running target/release/math_test-e31ed91ae51ebf22

running 1 test
test math_works ... ok

test result: ok. 1 passed; 0 failed; 0 ignored; 0 measured

```

(You’ll also see some output about “doc-tests,” which we’ll get to in a minute.)

This works the same whether your crate is an executable or a library. You can run specific tests by passing arguments to Cargo: `cargo test math` runs all tests that contain `math` somewhere in their name.

Tests commonly use the `assert!` and `assert_eq!` macros from the Rust standard library. `assert!(expr)` succeeds if `expr` is true. Otherwise, it panics, which causes the test to fail. `assert_eq!(v1, v2)` is just like `assert!(v1 == v2)` except that if the assertion fails, the error message shows both values.

You can use these macros in ordinary code, to check invariants, but note that `assert!` and `assert_eq!` are included even in release builds. Use `debug_assert!` and `debug_assert_eq!` instead to write assertions that are checked only in debug builds.

To test error cases, add the `#[should_panic]` attribute to your test:

```

/// This test passes only if division by zero causes a panic,
/// as we claimed in the previous chapter.

```



```
#[test]
#[should_panic(expected="divide by zero")]
fn test_divide_by_zero_error() {
    1 / 0; // should panic!
}
```

Functions marked with `#[test]` are conditionally compiled. When you run `cargo test`, Cargo builds a copy of your program with your tests and the test harness enabled. A plain `cargo build` or `cargo build --release` skips the testing code. This means your unit tests can live right alongside the code they test, accessing internal implementation details if they need to, and yet there's no runtime cost. However, it can result in some warnings. For example:

```
fn roughly_equal(a: f64, b: f64) -> bool {
    (a - b).abs() < 1e-6
}

#[test]
fn trig_works() {
    use std::f64::consts::PI;
    assert!(roughly_equal(PI.sin(), 0.0));
}
```

In a testing build, this is fine. In a nontesting build, `roughly_equal` is unused, and Rust will complain:

```
$ cargo build
   Compiling math_test v0.1.0 (file:///.../math_test)
warning: function is never used: `roughly_equal`
  --> src/crates_unused_testing_function.rs:7:1
   |
 7 | / fn roughly_equal(a: f64, b: f64) -> bool {
 8 | |     (a - b).abs() < 1e-6
 9 | | }
   | |_^
   |
   = note: #[warn(dead_code)] on by default
```

So the convention, when your tests get substantial enough to require support code, is to put them in a `tests` module and declare the whole module to be testing-only using the `#[cfg(test)]` attribute:

```
#[cfg(test)] // include this module only when testing
mod tests {
    fn roughly_equal(a: f64, b: f64) -> bool {
        (a - b).abs() < 1e-6
    }

    #[test]
    fn trig_works() {
        use std::f64::consts::PI;
        assert!(roughly_equal(PI.sin(), 0.0));
    }
}
```

```
}  
}
```

Rust’s test harness uses multiple threads to run several tests at a time, a nice side benefit of your Rust code being thread-safe by default. (To disable this, either run a single test, `cargo test testname`; or set the environment variable `RUST_TEST_THREADS` to 1.) This means that, technically, the Mandelbrot program we showed in [Chapter 2](#) was not the second multithreaded program in that chapter, but the third! The `cargo test` run in [“Writing and Running Unit Tests” on page 11](#) was the first.

## Integration Tests

Your fern simulator continues to grow. You’ve decided to put all the major functionality into a library that can be used by multiple executables. It would be nice to have some tests that link with the library the way an end user would, using `fern_sim.rlib` as an external crate. Also, you have some tests that start by loading a saved simulation from a binary file, and it is awkward having those large test files in your `src` directory. Integration tests help with these two problems.

Integration tests are `.rs` files that live in a `tests` directory alongside your project’s `src` directory. When you run `cargo test`, Cargo compiles each integration test as a separate, standalone crate, linked with your library and the Rust test harness. Here is an example:

```
// tests/unfurl.rs - Fiddleheads unfurl in sunlight  
  
extern crate fern_sim;  
use fern_sim::Terrarium;  
use std::time::Duration;  
  
#[test]  
fn test_fiddlehead_unfurling() {  
    let mut world = Terrarium::load("tests/unfurl_files/fiddlehead.tm");  
    assert!(world.fern(0).is_furled());  
    let one_hour = Duration::from_secs(60 * 60);  
    world.apply_sunlight(one_hour);  
    assert!(world.fern(0).is_fully_unfurled());  
}
```

Note that the integration test includes an `extern crate` declaration, since it uses `fern_sim` as a library. The point of integration tests is that they see your crate from the outside, just as a user would. They test the crate’s public API.

`cargo test` runs both unit tests and integration tests. To run only the integration tests in a particular file—for example, `tests/unfurl.rs`—use the command `cargo test --test unfurl`.

## Documentation

The command `cargo doc` creates HTML documentation for your library:

```
$ cargo doc --no-deps --open
Documenting fern_sim v0.1.0 (file:///.../fern_sim)
```

The `--no-deps` option tells Cargo to generate documentation only for `fern_sim` itself, and not for all the crates it depends on.

The `--open` option tells Cargo to open the documentation in your browser afterward.

You can see the result in [Figure 8-2](#). Cargo saves the new documentation files in `target/doc`. The starting page is `target/doc/fern_sim/index.html`.

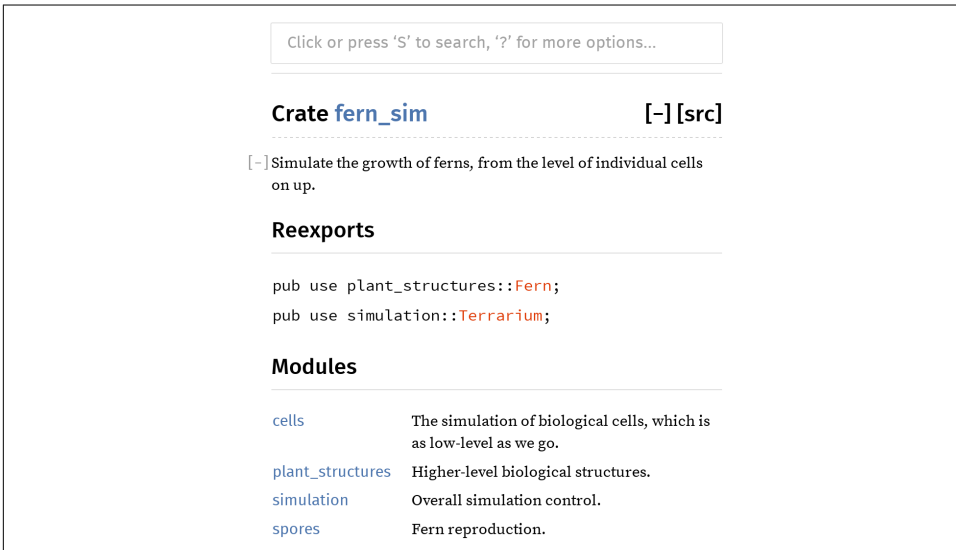

Figure 8-2. Example of documentation generated by `rustdoc`

The documentation is generated from the `pub` features of your library, plus any `doc` comments you've attached to them. We've seen a few `doc` comments in this chapter already. They look like comments:

```
/// Simulate the production of a spore by meiosis.
pub fn produce_spore(factory: &mut Sporangium) -> Spore {
    ...
}
```

But when Rust sees comments that start with three slashes, it treats them as a `#[doc]` attribute instead. Rust treats the preceding example exactly the same as this:

```
#[doc = "Simulate the production of a spore by meiosis."]
pub fn produce_spore(factory: &mut Sporangium) -> Spore {
```

```
} ...
```

When you compile or test a library, these attributes are ignored. When you generate documentation, doc comments on public features are included in the output.

Likewise, comments starting with `//!` are treated as `#![doc]` attributes, and are attached to the enclosing feature, typically a module or crate. For example, your `fern_sim/src/lib.rs` file might begin like this:

```
//! Simulate the growth of ferns, from the level of  
//! individual cells on up.
```

The content of a doc comment is treated as Markdown, a shorthand notation for simple HTML formatting. Asterisks are used for *italics* and **bold type**, a blank line is treated as a paragraph break, and so on. However, you can also fall back on HTML; any HTML tags in your doc comments are copied through verbatim into the documentation.

You can use ``backticks`` to set off bits of code in the middle of running text. In the output, these snippets will be formatted in a fixed-width font. Larger code samples can be added by indenting four spaces.

```
/// A block of code in a doc comment:  
///  
///     if everything().works() {  
///         println!("ok");  
///     }
```

You can also use Markdown fenced code blocks. This has exactly the same effect.

```
/// Another snippet, the same code, but written differently:  
///  
/// ```  
/// if everything().works() {  
///     println!("ok");  
/// }  
/// ```
```

Whichever format you use, an interesting thing happens when you include a block of code in a doc comment. Rust automatically turns it into a test.

## Doc-Tests

When you run tests in a Rust library crate, Rust checks that all the code that appears in your documentation actually runs and works. It does this by taking each block of code that appears in a doc comment, compiling it as a separate executable crate, linking it with your library, and running it.

Here is a standalone example of a doc-test. Create a new project by running `cargo new ranges` and put this code in `ranges/src/lib.rs`:

```

use std::ops::Range;

/// Return true if two ranges overlap.
///
///     assert_eq!(ranges::overlap(0..7, 3..10), true);
///     assert_eq!(ranges::overlap(1..5, 101..105), false);
///
/// If either range is empty, they don't count as overlapping.
///
///     assert_eq!(ranges::overlap(0..0, 0..10), false);
///
pub fn overlap(r1: Range<usize>, r2: Range<usize>) -> bool {
    r1.start < r1.end && r2.start < r2.end &&
    r1.start < r2.end && r2.start < r1.end
}

```

The two small blocks of code in the doc comment appear in the documentation generated by cargo doc, as shown in Figure 8-3.

## Function ranges::overlap

[-] [src]

---

```
pub fn overlap(r1: Range<usize>, r2: Range<usize>) -> bool
```

[-] Return true if two ranges overlap.

```
assert_eq!(ranges::overlap(0..7, 3..10), true);
assert_eq!(ranges::overlap(1..5, 101..105), false);
```

If either range is empty, they don't count as overlapping.

```
assert_eq!(ranges::overlap(0..0, 0..10), false);
```

Figure 8-3. Documentation showing some doc-tests

They also become two separate tests:

```

$ cargo test
  Compiling ranges v0.1.0 (file:///.../ranges)
  ...
  Doc-tests ranges

running 2 tests
test overlap_0 ... ok
test overlap_1 ... ok

test result: ok. 2 passed; 0 failed; 0 ignored; 0 measured

```

If you pass the `--verbose` flag to Cargo, you'll see that it's using `rustdoc --test` to run these two tests. Rustdoc stores each code sample in a separate file, adding a few lines of boilerplate code, to produce two programs. Here's the first:

```
extern crate ranges;
fn main() {
    assert_eq!(ranges::overlap(0..7, 3..10), true);
    assert_eq!(ranges::overlap(1..5, 101..105), false);
}
```

And here's the second:

```
extern crate ranges;
fn main() {
    assert_eq!(ranges::overlap(0..0, 0..10), false);
}
```

The tests pass if these programs compile and run successfully.

These two code samples contain assertions, but that's just because in this case, the assertions make decent documentation. The idea behind doc-tests is not to put all your tests into comments. Rather, you write the best possible documentation, and Rust makes sure the code samples in your documentation actually compile and run.

Very often a minimal working example includes some details, such as imports or setup code, that are necessary to make the code compile, but just aren't important enough to show in the documentation. To hide a line of a code sample, put a `#` followed by a space at the beginning of that line:

```
/// Let the sun shine in and run the simulation for a given
/// amount of time.
///
/// # use fern_sim::Terrarium;
/// # use std::time::Duration;
/// # let mut tm = Terrarium::new();
/// tm.apply_sunlight(Duration::from_secs(60));
///
pub fn apply_sunlight(&mut self, time: Duration) {
    ...
}
```

Sometimes it's helpful to show a complete sample program in documentation, including a `main` function and an `extern crate` declaration. Obviously, if those pieces of code appear in your code sample, you do not also want Rustdoc to add them automatically. The result wouldn't compile. Rustdoc therefore treats any code block containing the exact string `fn main` as a complete program, and doesn't add anything to it.

Testing can be disabled for specific blocks of code. To tell Rust to compile your example, but stop short of actually running it, use a fenced code block with the `no_run` annotation:

```

/// Upload all local terrariums to the online gallery.
///
/// ``no_run
/// let mut session = fern_sim::connect();
/// session.upload_all();
/// ```
pub fn upload_all(&mut self) {
    ...
}

```

If the code isn't even expected to compile, use `ignore` instead of `no_run`. If the code block isn't Rust code at all, use the name of the language, like `c++` or `sh`, or `text` for plain text. `rustdoc` doesn't know the names of hundreds of programming languages; rather, it treats any annotation it doesn't recognize as indicating that the code block isn't Rust. This disables code highlighting as well as doc-testing.

## Specifying Dependencies

We've seen one way of telling Cargo where to get source code for crates your project depends on: by version number.

```
image = "0.6.1"
```

There are several ways to specify dependencies, and some rather nuanced things you might want to say about which versions to use, so it's worth spending a few pages on this.

First of all, you may want to use dependencies that aren't published on `crates.io` at all. One way to do this is by specifying a Git repository URL and revision:

```
image = { git = "https://github.com/Piston/image.git", rev = "528f19c" }
```

This particular crate is open source, hosted on GitHub, but you could just as easily point to a private Git repository hosted on your corporate network. As shown here, you can specify the particular `rev`, `tag`, or `branch` to use. (These are all ways of telling Git which revision of the source code to check out.)

Another alternative is to specify a directory that contains the crate's source code:

```
image = { path = "vendor/image" }
```

This is convenient when your team has a single version control repository that contains source code for several crates, or perhaps the entire dependency graph. Each crate can specify its dependencies using relative paths.

Having this level of control over your dependencies is powerful. If you ever decide that any of the open source crates you use isn't exactly to your liking, you can trivially fork it: just hit the Fork button on GitHub and change one line in your `Cargo.toml` file. Your next `cargo build` will seamlessly use your fork of the crate instead of the official version.

## Versions

When you write something like `image = "0.6.1"` in your *Cargo.toml* file, Cargo interprets this rather loosely. It uses the most recent version of `image` that is considered compatible with version 0.6.1.

The compatibility rules are adapted from [Semantic Versioning](#).

- A version number that starts with 0.0 is so raw that Cargo never assumes it's compatible with any other version.
- A version number that starts with 0.x, where x is nonzero, is considered compatible with other point releases in the 0.x series. We specified `image` version 0.6.1, but Cargo would use 0.6.3 if available. (This is not what the Semantic Versioning standard says about 0.x version numbers, but the rule proved too useful to leave out.)
- Once a project reaches 1.0, only new major versions break compatibility. So if you ask for version 2.0.1, Cargo might use 2.17.99 instead, but not 3.0.

Version numbers are flexible by default because otherwise the problem of which version to use would quickly become overconstrained. Suppose one library, `libA`, used `num = "0.1.31"` while another, `libB`, used `num = "0.1.29"`. If version numbers required exact matches, no project would be able to use those two libraries together. Allowing Cargo to use any compatible version is a much more practical default.

Still, different projects have different needs when it comes to dependencies and versioning. You can specify an exact version or range of versions by using operators:

Cargo.toml line	Meaning
<code>image = "=0.10.0"</code>	Use only the exact version 0.10.0
<code>image = "&gt;=1.0.5"</code>	Use 1.0.5 or <i>any</i> higher version (even 2.9, if it's available)
<code>image = "&gt;1.0.5 &lt;1.1.9"</code>	Use a version that's higher than 1.0.5, but lower than 1.1.9
<code>image = "&lt;=2.7.10"</code>	use any version up to 2.7.10

Another version specification you'll occasionally see is the wildcard `*`. This tells Cargo that any version will do. Unless some other *Cargo.toml* file contains a more specific constraint, Cargo will use the latest available version. [The Cargo documentation at \*doc.crates.io\*](#) covers version specifications in even more detail.

Note that the compatibility rules mean that version numbers can't be chosen purely for marketing reasons. They actually mean something. They're a contract between a crate's maintainers and its users. If you maintain a crate that's at version 1.7, and you decide to remove a function or make any other change that isn't fully backward compatible, you must bump your version number to 2.0. If you were to call it 1.8, you'd be



claiming that the new version is compatible with 1.7, and your users might find themselves with broken builds.

## Cargo.lock

The version numbers in *Cargo.toml* are deliberately flexible, yet we don't want Cargo to upgrade us to the latest library versions every time we build. Imagine being in the middle of an intense debugging session when suddenly `cargo build` upgrades you to a new version of a library. This could be incredibly disruptive. Anything changing in the middle of debugging is bad. In fact, when it comes to libraries, there's never a good time for an unexpected change.

Cargo therefore has a built-in mechanism to prevent this. The first time you build a project, Cargo outputs a *Cargo.lock* file that records the exact version of every crate it used. Later builds will consult this file and continue to use the same versions. Cargo upgrades to newer versions only when you tell it to, either by manually bumping up the version number in your *Cargo.toml* file, or by running `cargo update`:

```
$ cargo update
  Updating registry `https://github.com/rust-lang/crates.io-index`
  Updating libc v0.2.7 -> v0.2.11
  Updating png v0.4.2 -> v0.4.3
```

`cargo update` only upgrades to the latest versions that are compatible with what you've specified in *Cargo.toml*. If you've specified `image = "0.6.1"`, and you want to upgrade to version 0.10.0, you'll have to change that in *Cargo.toml*. The next time you build, Cargo will update to the new version of the `image` library and store the new version number in *Cargo.lock*.

The preceding example shows Cargo updating two crates that are hosted on [crates.io](https://crates.io). Something very similar happens for dependencies that are stored in Git. Suppose our *Cargo.toml* file contains this:

```
image = { git = "https://github.com/Piston/image.git", branch = "master" }
```

`cargo build` will not pull new changes from the Git repository if it sees that we've got a *Cargo.lock* file. Instead, it reads *Cargo.lock* and uses the same revision as last time. But `cargo update` will pull from `master`, so that our next build uses the latest revision.

*Cargo.lock* is automatically generated for you, and you normally won't edit it by hand. Nonetheless, if your project is an executable, you should commit *Cargo.lock* to version control. That way, everyone who builds your project will consistently get the same versions. The history of your *Cargo.lock* file will record your dependency updates.

If your project is an ordinary Rust library, don't bother committing *Cargo.lock*. Your library's downstream users will have *Cargo.lock* files that contain version information for their entire dependency graph; they will ignore your library's *Cargo.lock* file. In the rare case that your project is a shared library (i.e., the output is a *.dll*, *.dylib*, or *.so* file), there is no such downstream cargo user, and you should therefore commit *Cargo.lock*.

*Cargo.toml*'s flexible version specifiers make it easy to use Rust libraries in your project and maximize compatibility among libraries. *Cargo.lock*'s bookkeeping supports consistent, reproducible builds across machines. Together, they go a long way toward helping you avoid dependency hell.

## Publishing Crates to crates.io

You've decided to publish your fern-simulating library as open source software. Congratulations! This part is easy.

First, make sure Cargo can pack the crate for you.

```
$ cargo package
warning: manifest has no description, license, license-file, documentation,
homepage or repository. See http://doc.crates.io/manifest.html#package-metadata
for more info.
Packaging fern_sim v0.1.0 (file:///.../fern_sim)
Verifying fern_sim v0.1.0 (file:///.../fern_sim)
Compiling fern_sim v0.1.0 (file:///.../fern_sim/target/package/fern_sim-0.1.0)
```

The `cargo package` command creates a file (in this case, *target/package/fern\_sim-0.1.0.crate*) containing all your library's source files, including *Cargo.toml*. This is the file that you'll upload to [crates.io](https://crates.io) to share with the world. (You can use `cargo package --list` to see which files are included.) Cargo then double-checks its work by building your library from the *.crate* file, just as your eventual users will.

Cargo warns that the `[package]` section of *Cargo.toml* is missing some information that will be important to downstream users, such as the license under which you're distributing the code. The URL in the warning is an excellent resource, so we won't explain all the fields in detail here. In short, you can fix the warning by adding a few lines to *Cargo.toml*:

```
[package]
name = "fern_sim"
version = "0.1.0"
authors = ["You <you@example.com>"]
license = "MIT"
homepage = "https://fernsim.example.com/"
repository = "https://gitlair.com/sporeador/fern_sim"
documentation = "http://fernsim.example.com/docs"
description = ""
```

```
Fern simulation, from the cellular level up.
"""
```



Once you publish this crate on crates.io, anyone who downloads your crate can see the *Cargo.toml* file. So if the `authors` field contains an email address that you'd rather keep private, now's the time to change it.

Another problem that sometimes arises at this stage is that your *Cargo.toml* file might be specifying the location of other crates by path, as shown in “[Specifying Dependencies](#)” on page 185:

```
image = { path = "vendor/image" }
```

For you and your team, this might work fine. But naturally, when other people download the `fern_sim` library, they will not have the same files and directories on their computer that you have. Cargo therefore *ignores* the `path` key in automatically downloaded libraries, and this can cause build errors. The fix, however, is straightforward: if your library is going to be published on crates.io, its dependencies should be on crates.io too. Specify a version number instead of a path:

```
image = "0.6.1"
```

If you prefer, you can specify both a path, which takes precedence for your own local builds, and a version for all other users:

```
image = { path = "vendor/image", version = "0.6.1" }
```

Of course, in that case it's your responsibility to make sure that the two stay in sync.

Lastly, before publishing a crate, you'll need to log in to crates.io and get an API key. This step is straightforward: once you have an account on crates.io, your “Account Settings” page will show a `cargo login` command, like this one:

```
$ cargo login 5j0dV54BjLXBpUUbfIj7G9DvNl1vsWW1
```

Cargo saves the key in a configuration file, and the API key should be kept secret, like a password. So run this command only on a computer you control.

That done, the final step is to run `cargo publish`:

```
$ cargo publish
  Updating registry `https://github.com/rust-lang/crates.io-index`
  Uploading fern_sim v0.1.0 (file:///.../fern_sim)
```

With this, your library joins thousands of others on crates.io.

# Workspaces

As your project continues to grow, you end up writing many crates. They live side by side in a single source repository:

```
fernsoft/  
├── .git/...  
├── fern_sim/  
│   ├── Cargo.toml  
│   ├── Cargo.lock  
│   ├── src/...  
│   └── target/...  
├── fern_img/  
│   ├── Cargo.toml  
│   ├── Cargo.lock  
│   ├── src/...  
│   └── target/...  
└── fern_video/  
    ├── Cargo.toml  
    ├── Cargo.lock  
    ├── src/...  
    └── target/...
```

The way Cargo works, each crate has its own build directory, `target`, which contains a separate build of all that crate's dependencies. These build directories are completely independent. Even if two crates have a common dependency, they can't share any compiled code. This is wasteful.

You can save compilation time and disk space by using a Cargo *workspace*, a collection of crates that share a common build directory and *Cargo.lock* file.

All you need to do is create a *Cargo.toml* file in your repository's root directory and put these lines in it:

```
[workspace]  
members = ["fern_sim", "fern_img", "fern_video"]
```

where `fern_sim` etc. are the names of the subdirectories containing your crates. Delete any leftover *Cargo.lock* files and *target* directories that exist in those subdirectories.

Once you've done this, `cargo build` in any crate will automatically create and use a shared build directory under the root directory (in this case, `fernsoft/target`). The command `cargo build --all` builds all crates in the current workspace. `cargo test` and `cargo doc` accept the `--all` option as well.

## More Nice Things

In case you're not delighted yet, the Rust community has a few more odds and ends for you:

- When you publish an open source crate on [crates.io](https://crates.io), your documentation is automatically rendered and hosted on *docs.rs* thanks to Onur Aslan.
- If your project is on GitHub, Travis CI can build and test your code on every push. It's surprisingly easy to set up; see [travis-ci.org](https://travis-ci.org) for details. If you're already familiar with Travis, this *.travis.yml* file will get you started:

```
language: rust
rust:
  - stable
```

- You can generate a *README.md* file from your crate's top-level doc-comment. This feature is offered as a third-party Cargo plugin by Livio Ribeiro. Run `cargo install readme` to install the plugin, then `cargo readme --help` to learn how to use it.

We could go on.

Rust is new, but it's designed to support large, ambitious projects. It has great tools and an active community. System programmers *can* have nice things.



## CHAPTER 9

---

# Structs

*Long ago, when shepherds wanted to see if two herds of sheep were isomorphic, they would look for an explicit isomorphism.*

—John C. Baez and James Dolan, “[Categorification](#)”

Rust structs, sometimes called *structures*, resemble `struct` types in C and C++, classes in Python, and objects in JavaScript. A struct assembles several values of assorted types together into a single value, so you can deal with them as a unit. Given a struct, you can read and modify its individual components. And a struct can have methods associated with it that operate on its components.

Rust has three kinds of struct types, *named-field*, *tuple-like*, and *unit-like*, which differ in how you refer to their components: a named-field struct gives a name to each component, whereas a tuple-like struct identifies them by the order in which they appear. Unit-like structs have no components at all; these are not common, but more useful than you might think.

In this chapter, we’ll explain each kind in detail, and show what they look like in memory. We’ll cover how to add methods to them, how to define generic struct types that work with many different component types, and how to ask Rust to generate implementations of common handy traits for your structs.

## Named-Field Structs

The definition of a named-field struct type looks like this:

```
/// A rectangle of eight-bit grayscale pixels.
struct GrayscaleMap {
    pixels: Vec<u8>,
    size: (usize, usize)
}
```

This declares a type `GrayscaleMap` with two fields named `pixels` and `size`, of the given types. The convention in Rust is for all types, structs included, to have names that capitalize the first letter of each word, like `GrayscaleMap`, a convention called *CamelCase*. Fields and methods are lowercase, with words separated by underscores. This is called *snake\_case*.

You can construct a value of this type with a *struct expression*, like this:

```
let width = 1024;
let height = 576;
let image = GrayscaleMap {
    pixels: vec![0; width * height],
    size: (width, height)
};
```

A struct expression starts with the type name (`GrayscaleMap`), and lists the name and value of each field, all enclosed in curly braces. There's also shorthand for populating fields from local variables or arguments with the same name:

```
fn new_map(size: (usize, usize), pixels: Vec<u8>) -> GrayscaleMap {
    assert_eq!(pixels.len(), size.0 * size.1);
    GrayscaleMap { pixels, size }
}
```

The struct expression `GrayscaleMap { pixels, size }` is short for `GrayscaleMap { pixels: pixels, size: size }`. You can use `key: value` syntax for some fields and shorthand for others in the same struct expression.

To access a struct's fields, use the familiar `.` operator:

```
assert_eq!(image.size, (1024, 576));
assert_eq!(image.pixels.len(), 1024 * 576);
```

Like all other items, structs are private by default, visible only in the module where they're declared. You can make a struct visible outside its module by prefixing its definition with `pub`. The same goes for each of its fields, which are also private by default:

```
/// A rectangle of eight-bit grayscale pixels.
pub struct GrayscaleMap {
    pub pixels: Vec<u8>,
    pub size: (usize, usize)
}
```

Even if a struct is declared `pub`, its fields can be private:

```
/// A rectangle of eight-bit grayscale pixels.
pub struct GrayscaleMap {
    pixels: Vec<u8>,
    size: (usize, usize)
}
```



Other modules can use this struct and any public methods it might have, but can't access the private fields by name or use struct expressions to create new `GrayscaleMap` values. That is, creating a struct value requires all the struct's fields to be visible. This is why you can't write a struct expression to create a new `String` or `Vec`. These standard types are structs, but all their fields are private. To create one, you must use public methods like `Vec::new()`.

When creating a named-field struct value, you can use another struct of the same type to supply values for fields you omit. In a struct expression, if the named fields are followed by `.. EXPR`, then any fields not mentioned take their values from `EXPR`, which must be another value of the same struct type. Suppose we have a struct representing a monster in a game:

```
struct Broom {
    name: String,
    height: u32,
    health: u32,
    position: (f32, f32, f32),
    intent: BroomIntent
}

// Two possible alternatives for what a `Broom` could be working on.
#[derive(Copy, Clone)]
enum BroomIntent { FetchWater, DumpWater }
```

The best fairy tale for programmers is *The Sorcerer's Apprentice*: a novice magician enchants a broom to do his work for him, but doesn't know how to stop it when the job is done. Chopping the broom in half with an axe just produces two brooms, each of half the size, but continuing the task with the same blind dedication as the original:

```
// Receive the input Broom by value, taking ownership.
fn chop(b: Broom) -> (Broom, Broom) {
    // Initialize `broom1` mostly from `b`, changing only `height`. Since
    // `String` is not `Copy`, `broom1` takes ownership of `b`'s name.
    let mut broom1 = Broom { height: b.height / 2, .. b };

    // Initialize `broom2` mostly from `broom1`. Since `String` is not
    // `Copy`, we must clone `name` explicitly.
    let mut broom2 = Broom { name: broom1.name.clone(), .. broom1 };

    // Give each fragment a distinct name.
    broom1.name.push_str(" I");
    broom2.name.push_str(" II");

    (broom1, broom2)
}
```

With that definition in place, we can create a broom, chop it in two, and see what we get:

```
let hokey = Broom {
    name: "Hokey".to_string(),
    height: 60,
    health: 100,
    position: (100.0, 200.0, 0.0),
    intent: BroomIntent::FetchWater
};

let (hokey1, hokey2) = chop(hokey);
assert_eq!(hokey1.name, "Hokey I");
assert_eq!(hokey1.health, 100);

assert_eq!(hokey2.name, "Hokey II");
assert_eq!(hokey2.health, 100);
```

## Tuple-Like Structs

The second kind of struct type is called a *tuple-like struct*, because it resembles a tuple:

```
struct Bounds(usize, usize);
```

You construct a value of this type much as you would construct a tuple, except that you must include the struct name:

```
let image_bounds = Bounds(1024, 768);
```

The values held by a tuple-like struct are called *elements*, just as the values of a tuple are. You access them just as you would a tuple's:

```
assert_eq!(image_bounds.0 * image_bounds.1, 786432);
```

Individual elements of a tuple-like struct may be public or not:

```
pub struct Bounds(pub usize, pub usize);
```

The expression `Bounds(1024, 768)` looks like a function call, and in fact it is: defining the type also implicitly defines a function:

```
fn Bounds(elem0: usize, elem1: usize) -> Bounds { ... }
```

At the most fundamental level, named-field and tuple-like structs are very similar. The choice of which to use comes down to questions of legibility, ambiguity, and brevity. If you will use the `.` operator to get at a value's components much at all, identifying fields by name provides the reader more information, and is probably more robust against typos. If you will usually use pattern matching to find the elements, tuple-like structs can work nicely.

Tuple-like structs are good for *newtypes*, structs with a single component that you define to get stricter type checking. For example, if you are working with ASCII-only text, you might define a newtype like this:

```
struct Ascii(Vec<u8>);
```

Using this type for your ASCII strings is much better than simply passing around `Vec<u8>` buffers and explaining what they are in the comments. The newtype helps Rust catch mistakes where some other byte buffer is passed to a function expecting ASCII text. We'll give an example of using newtypes for efficient type conversions in [Chapter 21](#).

## Unit-Like Structs

The third kind of struct is a little obscure: it declares a struct type with no elements at all:

```
struct Onesuch;
```

A value of such a type occupies no memory, much like the unit type `()`. Rust doesn't bother actually storing unit-like struct values in memory or generating code to operate on them, because it can tell everything it might need to know about the value from its type alone. But logically, an empty struct is a type with values like any other—or more precisely, a type of which there is only a single value:

```
let o = Onesuch;
```

You've already encountered a unit-like struct when reading about “[Fields and Elements](#)” on [page 135](#). Whereas an expression like `3..5` is shorthand for the struct value `Range { start: 3, end: 5 }`, the expression `..`, a range omitting both endpoints, is shorthand for the unit-like struct value `RangeFull`.

Unit-like structs can also be useful when working with traits, which we'll describe in [Chapter 11](#).

## Struct Layout

In memory, both named-field and tuple-like structs are the same thing: a collection of values, of possibly mixed types, laid out in a particular way in memory. For example, earlier in the chapter we defined this struct:

```
struct GrayscaleMap {
    pixels: Vec<u8>,
    size: (usize, usize)
}
```

A `GrayscaleMap` value is laid out in memory as diagrammed in [Figure 9-1](#).

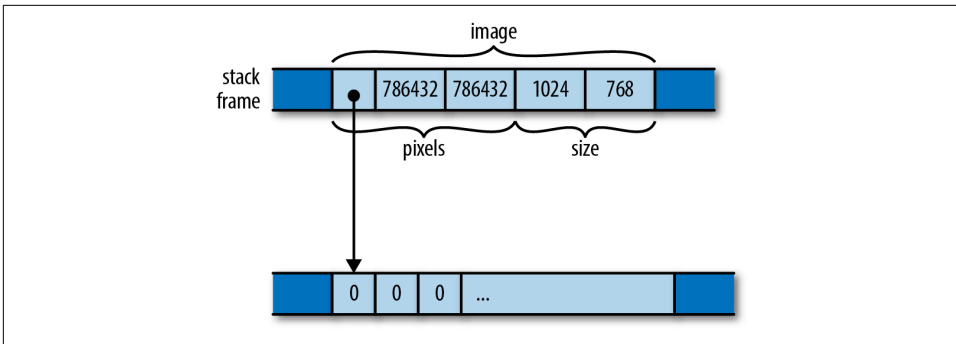

Figure 9-1. A `GrayscaleMap` structure in memory

Unlike C and C++, Rust doesn't make specific promises about how it will order a struct's fields or elements in memory; this diagram shows only one possible arrangement. However, Rust does promise to store fields' values directly in the struct's block of memory. Whereas JavaScript, Python, and Java would put the `pixels` and `size` values each in their own heap-allocated blocks and have `GrayscaleMap`'s fields point at them, Rust embeds `pixels` and `size` directly in the `GrayscaleMap` value. Only the heap-allocated buffer owned by the `pixels` vector remains in its own block.

You can ask Rust to lay out structures in a way compatible with C and C++, using the `#[repr(C)]` attribute. We'll cover this in detail in [Chapter 21](#).

## Defining Methods with `impl`

Throughout the book we've been calling methods on all sorts of values. We've pushed elements onto vectors with `v.push(e)`, fetched their length with `v.len()`, checked `Result` values for errors with `r.expect("msg")`, and so on.

You can define methods on any struct type you define. Rather than appearing inside the struct definition, as in C++ or Java, Rust methods appear in a separate `impl` block. For example:

```
/// A last-in, first-out queue of characters.
pub struct Queue {
    older: Vec<char>, // older elements, eldest last.
    younger: Vec<char> // younger elements, youngest last.
}

impl Queue {
    /// Push a character onto the back of a queue.
    pub fn push(&mut self, c: char) {
        self.younger.push(c);
    }

    /// Pop a character off the front of a queue. Return `Some(c)` if there

```

```

    /// was a character to pop, or `None` if the queue was empty.
    pub fn pop(&mut self) -> Option<char> {
        if self.older.is_empty() {
            if self.younger.is_empty() {
                return None;
            }

            // Bring the elements in younger over to older, and put them in
            // the promised order.
            use std::mem::swap;
            swap(&mut self.older, &mut self.younger);
            self.older.reverse();
        }

        // Now older is guaranteed to have something. Vec's pop method
        // already returns an Option, so we're set.
        self.older.pop()
    }
}

```

An `impl` block is simply a collection of `fn` definitions, each of which becomes a method on the struct type named at the top of the block. Here we've defined a public struct `Queue`, and then given it two public methods, `push` and `pop`.

Methods are also known as *associated functions*, since they're associated with a specific type. The opposite of an associated function is a *free function*, one that is not defined as an `impl` block's item.

Rust passes a method the value it's being called on as its first argument, which must have the special name `self`. Since `self`'s type is obviously the one named at the top of the `impl` block, or a reference to that, Rust lets you omit the type, and write `self`, `&self` or `&mut self` as shorthand for `self: Queue`, `self: &Queue` or `self: &mut Queue`. You can use the longhand forms if you like, but almost all Rust code uses the shorthand, as shown before.

In our example, the `push` and `pop` methods refer to the `Queue`'s fields as `self.older` and `self.younger`. Unlike C++ and Java, where the members of the “this” object are directly visible in method bodies as unqualified identifiers, a Rust method must explicitly use `self` to refer to the value it was called on, similar to the way Python methods use `self`, and the way JavaScript methods use `this`.

Since `push` and `pop` need to modify the `Queue`, they both take `&mut self`. However, when you call a method, you don't need to borrow the mutable reference yourself; the ordinary method call syntax takes care of that implicitly. So with these definitions in place, you can use `Queue` like this:

```

let mut q = Queue { older: Vec::new(), younger: Vec::new() };

q.push('0');

```

```

q.push('1');
assert_eq!(q.pop(), Some('0'));

q.push('∞');
assert_eq!(q.pop(), Some('1'));
assert_eq!(q.pop(), Some('∞'));
assert_eq!(q.pop(), None);

```

Simply writing `q.push(...)` borrows a mutable reference to `q`, as if you had written `(&mut q).push(...)`, since that's what the `push` method's `self` requires.

If a method doesn't need to modify its `self`, then you can define it to take a shared reference instead. For example:

```

impl Queue {
    pub fn is_empty(&self) -> bool {
        self.older.is_empty() && self.younger.is_empty()
    }
}

```

Again, the method call expression knows which sort of reference to borrow:

```

assert!(q.is_empty());
q.push('0');
assert!(!q.is_empty());

```

Or, if a method wants to take ownership of `self`, it can take `self` by value:

```

impl Queue {
    pub fn split(self) -> (Vec<char>, Vec<char>) {
        (self.older, self.younger)
    }
}

```

Calling this `split` method looks like the other method calls:

```

let mut q = Queue { older: Vec::new(), younger: Vec::new() };

q.push('P');
q.push('D');
assert_eq!(q.pop(), Some('P'));
q.push('X');

let (older, younger) = q.split();
// q is now uninitialized.
assert_eq!(older, vec!['D']);
assert_eq!(younger, vec!['X']);

```

But note that, since `split` takes its `self` by value, this *moves* the `Queue` out of `q`, leaving `q` uninitialized. Since `split`'s `self` now owns the queue, it's able to move the individual vectors out of it, and return them to the caller.

You can also define methods that don't take `self` as an argument at all. These become functions associated with the struct type itself, not with any specific value of the type. Following the tradition established by C++ and Java, Rust calls these *static methods*. They're often used to provide constructor functions, like this:

```
impl Queue {
    pub fn new() -> Queue {
        Queue { older: Vec::new(), younger: Vec::new() }
    }
}
```

To use this method, we refer to it as `Queue::new`: the type name, a double colon, and then the method name. Now our example code becomes a bit more svelte:

```
let mut q = Queue::new();

q.push('*');
...
```

It's conventional in Rust for constructor functions to be named `new`; we've already seen `Vec::new`, `Box::new`, `HashMap::new`, and others. But there's nothing special about the name `new`. It's not a keyword, and types often have other static methods that serve as constructors, like `Vec::with_capacity`.

Although you can have many separate `impl` blocks for a single type, they must all be in the same crate that defines that type. However, Rust does let you attach your own methods to other types; we'll explain how in [Chapter 11](#).

If you're used to C++ or Java, separating a type's methods from its definition may seem unusual, but there are several advantages to doing so:

- It's always easy to find a type's data members. In large C++ class definitions, you might need to skim hundreds of lines of member function definitions to be sure you haven't missed any of the class's data members; in Rust, they're all in one place.
- Although one can imagine fitting methods into the syntax for named-field structs, it's not so neat for tuple-like and unit-like structs. Pulling methods out into an `impl` block allows a single syntax for all three. In fact, Rust uses this same syntax for defining methods on types that are not structs at all, such as `enum` types and primitive types like `i32`. (The fact that any type can have methods is one reason Rust doesn't use the term *object* much, preferring to call everything a *value*.)
- The same `impl` syntax also serves neatly for implementing traits, which we'll go into in [Chapter 11](#).

# Generic Structs

Our earlier definition of `Queue` is unsatisfying: it is written to store characters, but there's nothing about its structure or methods that is specific to characters at all. If we were to define another struct that held, say, `String` values, the code could be identical, except that `char` would be replaced with `String`. That would be a waste of time.

Fortunately, Rust structs can be *generic*, meaning that their definition is a template into which you can plug whatever types you like. For example, here's a definition for `Queue` that can hold values of any type:

```
pub struct Queue<T> {
    older: Vec<T>,
    younger: Vec<T>
}
```

You can read the `<T>` in `Queue<T>` as “for any element type `T...`”. So this definition reads, “For any type `T`, a `Queue<T>` is two fields of type `Vec<T>`.” For example, in `Queue<String>`, `T` is `String`, so `older` and `younger` have type `Vec<String>`. In `Queue<char>`, `T` is `char`, and we get a struct identical to the `char`-specific definition we started with. In fact, `Vec` itself is a generic struct, defined in just this way.

In generic struct definitions, the type names used in `<angle brackets>` are called *type parameters*. An `impl` block for a generic struct looks like this:

```
impl<T> Queue<T> {
    pub fn new() -> Queue<T> {
        Queue { older: Vec::new(), younger: Vec::new() }
    }

    pub fn push(&mut self, t: T) {
        self.younger.push(t);
    }

    pub fn is_empty(&self) -> bool {
        self.older.is_empty() && self.younger.is_empty()
    }

    ...
}
```

You can read the line `impl<T> Queue<T>` as something like, “for any type `T`, here are some methods available on `Queue<T>`.” Then, you can use the type parameter `T` as a type in the method definitions.

We've used Rust's shorthand for `self` parameters in the preceding code; writing out `Queue<T>` everywhere becomes a mouthful and a distraction. As another shorthand, every `impl` block, generic or not, defines the special type parameter `Self` (note the `CamelCase` name) to be whatever type we're adding methods to. In the preceding



code, `Self` would be `Queue<T>`, so we can abbreviate `Queue::new`'s definition a bit further:

```
pub fn new() -> Self {
    Queue { older: Vec::new(), younger: Vec::new() }
}
```

You might have noticed that, in the body of `new`, we didn't need to write the type parameter in the construction expression; simply writing `Queue { ... }` was good enough. This is Rust's type inference at work: since there's only one type that works for that function's return value—namely, `Queue<T>`—Rust supplies the parameter for us. However, you'll always need to supply type parameters in function signatures and type definitions. Rust doesn't infer those; instead, it uses those explicit types as the basis from which it infers types within function bodies.

For static method calls, you can supply the type parameter explicitly using the turbofish `::<>` notation:

```
let mut q = Queue::<char>::new();
```

But in practice, you can usually just let Rust figure it out for you:

```
let mut q = Queue::new();
let mut r = Queue::new();

q.push("CAD"); // apparently a Queue<&'static str>
r.push(0.74); // apparently a Queue<f64>

q.push("BTC"); // Bitcoins per USD, 2017-5
r.push(2737.7); // Rust fails to detect irrational exuberance
```

In fact, this is exactly what we've been doing with `Vec`, another generic struct type, throughout the book.

It's not just structs that can be generic. Enums can take type parameters as well, with a very similar syntax. We'll show that in detail in [“Enums” on page 212](#).

## Structs with Lifetime Parameters

As we discussed in [“Structs Containing References” on page 109](#), if a struct type contains references, you must name those references' lifetimes. For example, here's a structure that might hold references to the greatest and least elements of some slice:

```
struct Extrema<'elt> {
    greatest: &'elt i32,
    least: &'elt i32
}
```

Earlier, we invited you to think of a declaration like `struct Queue<T>` as meaning that, given any specific type `T`, you can make a `Queue<T>` that holds that type. Simi-

larly, you can think of `struct Extrema<'elt>` as meaning that, given any specific lifetime `'elt`, you can make an `Extrema<'elt>` that holds references with that lifetime.

Here's a function to scan a slice and return an `Extrema` value whose fields refer to its elements:

```
fn find_extrema<'s>(slice: &'s [i32]) -> Extrema<'s> {
    let mut greatest = &slice[0];
    let mut least = &slice[0];

    for i in 1..slice.len() {
        if slice[i] < *least { least = &slice[i]; }
        if slice[i] > *greatest { greatest = &slice[i]; }
    }
    Extrema { greatest, least }
}
```

Here, since `find_extrema` borrows elements of `slice`, which has lifetime `'s`, the `Extrema` struct we return also uses `'s` as the lifetime of its references. Rust always infers lifetime parameters for calls, so calls to `find_extrema` needn't mention them:

```
let a = [0, -3, 0, 15, 48];
let e = find_extrema(&a);
assert_eq!(*e.least, -3);
assert_eq!(*e.greatest, 48);
```

Because it's so common for the return type to use the same lifetime as an argument, Rust lets us omit the lifetimes when there's one obvious candidate. We could also have written `find_extrema`'s signature like this, with no change in meaning:

```
fn find_extrema(slice: &[i32]) -> Extrema {
    ...
}
```

Granted, we *might* have meant `Extrema<'static>`, but that's pretty unusual. Rust provides a shorthand for the common case.

## Deriving Common Traits for Struct Types

Structs can be very easy to write:

```
struct Point {
    x: f64,
    y: f64
}
```

However, if you were to start using this `Point` type, you would quickly notice that it's a bit of a pain. As written, `Point` is not copyable or cloneable. You can't print it with `println!("{:?}", point)`; and it does not support the `==` and `!=` operators.

Each of these features has a name in Rust—Copy, Clone, Debug, and PartialEq. They are called *traits*. In [Chapter 11](#), we’ll show how to implement traits by hand for your own structs. But in the case of these standard traits, and several others, you don’t need to implement them by hand unless you want some kind of custom behavior. Rust can automatically implement them for you, with mechanical accuracy. Just add a `#[derive]` attribute to the struct:

```
#[derive(Copy, Clone, Debug, PartialEq)]
struct Point {
    x: f64,
    y: f64
}
```

Each of these traits can be implemented automatically for a struct, provided that each of its fields implements the trait. We can ask Rust to derive `PartialEq` for `Point` because its two fields are both of type `f64`, which already implements `PartialEq`.

Rust can also derive `PartialCmp`, which would add support for the comparison operators `<`, `>`, `<=`, and `>=`. We haven’t done so here, because comparing two points to see if one is “less than” the other is actually a pretty weird thing to do. There’s no one conventional order on points. So we choose not to support those operators for `Point` values. Cases like this are one reason that Rust makes us write the `#[derive]` attribute rather than automatically deriving every trait it can. Another reason is that implementing a trait is automatically a public feature, so copyability, cloneability, and so forth are all part of your struct’s public API and should be chosen deliberately.

We’ll describe Rust’s standard traits in detail, and tell which ones are `#[derive]`able, in [Chapter 13](#).

## Interior Mutability

Mutability is like anything else: in excess, it causes problems, but you often want just a little bit of it. For example, say your spider robot control system has a central struct, `SpiderRobot`, that contains settings and I/O handles. It’s set up when the robot boots, and the values never change:

```
pub struct SpiderRobot {
    species: String,
    web_enabled: bool,
    leg_devices: [fd::FileDesc; 8],
    ...
}
```

Every major system of the robot is handled by a different struct, and each one has a pointer back to the `SpiderRobot`:

```
use std::rc::Rc;

pub struct SpiderSenses {
    robot: Rc<SpiderRobot>, // <-- pointer to settings and I/O
    eyes: [Camera; 32],
    motion: Accelerometer,
    ...
}
```

The structs for web construction, predation, venom flow control, and so forth also each have an `Rc<SpiderRobot>` smart pointer. Recall that `Rc` stands for **reference counting**, and a value in an `Rc` box is always shared and therefore always immutable.

Now suppose you want to add a little logging to the `SpiderRobot` struct, using the standard `File` type. There's a problem: a `File` has to be `mut`. All the methods for writing to it require a `mut` reference.

This sort of situation comes up fairly often. What we need is a little bit of mutable data (a `File`) inside an otherwise immutable value (the `SpiderRobot` struct). This is called *interior mutability*. Rust offers several flavors of it; in this section, we'll discuss the two most straightforward types: `Cell<T>` and `RefCell<T>`, both in the `std::cell` module.

A `Cell<T>` is a struct that contains a single private value of type `T`. The only special thing about a `Cell` is that you can get and set the field even if you don't have `mut` access to the `Cell` itself:

- `Cell::new(value)` creates a new `Cell`, moving the given value into it.
- `cell.get()` returns a copy of the value in the cell.
- `cell.set(value)` stores the given value in the cell, dropping the previously stored value.

This method takes `self` as a non-`mut` reference:

```
fn set(&self, value: T) // note: not `&mut self`
```

This is, of course, unusual for methods named `set`. By now, Rust has trained us to expect that we need `mut` access if we want to make changes to data. But by the same token, this one unusual detail is the whole point of `Cells`. They're simply a safe way of bending the rules on immutability—no more, no less.

`Cells` also have a few other methods, which you can read about **in the documentation**.

A `Cell` would be handy if you were adding a simple counter to your `SpiderRobot`. You could write:

```

use std::cell::Cell;

pub struct SpiderRobot {
    ...
    hardware_error_count: Cell<u32>,
    ...
}

```

and then even non-mut methods of SpiderRobot can access that u32, using the .get() and .set() methods:

```

impl SpiderRobot {
    /// Increase the error count by 1.
    pub fn add_hardware_error(&self) {
        let n = self.hardware_error_count.get();
        self.hardware_error_count.set(n + 1);
    }

    /// True if any hardware errors have been reported.
    pub fn has_hardware_errors(&self) -> bool {
        self.hardware_error_count.get() > 0
    }
}

```

This is easy enough, but it doesn't solve our logging problem. Cell does *not* let you call mut methods on a shared value. The .get() method returns a copy of the value in the cell, so it works only if T implements the [Copy trait](#). For logging, we need a mutable File, and File isn't copyable.

The right tool in this case is a RefCell. Like Cell<T>, RefCell<T> is a generic type that contains a single value of type T. Unlike Cell, RefCell supports borrowing references to its T value:

- **RefCell::new(value)** creates a new RefCell, moving value into it.
- **ref\_cell.borrow()** returns a Ref<T>, which is essentially just a shared reference to the value stored in ref\_cell.  
This method panics if the value is already mutably borrowed; see details to follow.
- **ref\_cell.borrow\_mut()** returns a RefMut<T>, essentially a mutable reference to the value in ref\_cell.  
This method panics if the value is already borrowed; see details to follow.

Again, RefCell has a few other methods, which you can find [in the documentation](#).

The two borrow methods panic only if you try to break the Rust rule that mut references are exclusive references. For example, this would panic:

```

let ref_cell: RefCell<String> = RefCell::new("hello".to_string());

let r = ref_cell.borrow(); // ok, returns a Ref<String>
let count = r.len(); // ok, returns "hello".len()
assert_eq!(count, 5);

let mut w = ref_cell.borrow_mut(); // panic: already borrowed
w.push_str(" world");

```

To avoid panicking, you could put these two borrows into separate blocks. That way, `r` would be dropped before you try to borrow `w`.

This is a lot like how normal references work. The only difference is that normally, when you borrow a reference to a variable, Rust checks *at compile time* to ensure that you’re using the reference safely. If the checks fail, you get a compiler error. `RefCell` enforces the same rule using runtime checks. So if you’re breaking the rules, you get a panic.

Now we’re ready to put `RefCell` to work in our `SpiderRobot` type:

```

pub struct SpiderRobot {
    ...
    log_file: RefCell<File>,
    ...
}

impl SpiderRobot {
    /// Write a line to the log file.
    pub fn log(&self, message: &str) {
        let mut file = self.log_file.borrow_mut();
        writeln!(file, "{}", message).unwrap();
    }
}

```

The variable `file` has type `RefMut<File>`. It can be used just like a mutable reference to a `File`. For details about writing to files, see [Chapter 18](#).

Cells are easy to use. Having to call `.get()` and `.set()` or `.borrow()` and `.borrow_mut()` is slightly awkward, but that’s just the price we pay for bending the rules. The other drawback is less obvious and more serious: cells—and any types that contain them—are not thread-safe. Rust therefore **will not allow** multiple threads to access them at once. We’ll describe thread-safe flavors of interior mutability in [Chapter 19](#), when we discuss “`Mutex<T>`” on page 486, “`Atomics`” on page 494, and “`Global Variables`” on page 496.

Whether a struct has named fields or is tuple-like, it is an aggregation of other values: if I have a `SpiderSenses` struct, then I have an `Rc` pointer to a shared `SpiderRobot` struct, and I have eyes, and I have an accelerometer, and so on. So the essence of a struct is the word “and”: I have an X *and* a Y. But what if there were another kind of type built around the word “or”? That is, when you have a value of such a type, you’d

have *either* an X *or* a Y? Such types turn out to be so useful that they're ubiquitous in Rust, and they are the subject of the next chapter.





---

# Enums and Patterns

*Surprising how much computer stuff makes sense viewed as tragic deprivation of sum types  
(cf. deprivation of lambdas)*

—Graydon Hoare

The first topic of this chapter is potent, as old as the hills, happy to help you get a lot done in short order (for a price), and known by many names in many cultures. But it's not the devil. It's a kind of user-defined data type, long known to ML and Haskell hackers as sum types, discriminated unions, or algebraic data types. In Rust, they are called *enumerations*, or simply *enums*. Unlike the devil, they are quite safe, and the price they ask is no great privation.

C++ and C# have enums; you can use them to define your own type whose values are a set of named constants. For example, you might define a type named `Color` with values `Red`, `Orange`, `Yellow`, and so on. This kind of enum works in Rust, too. But Rust takes enums much further. A Rust enum can also contain data, even data of varying types. For example, Rust's `Result<String, io::Error>` type is an enum; such a value is either an `Ok` value containing a `String`, or an `Err` value containing an `io::Error`. This is beyond what C++ and C# enums can do. It's more like a C union—but unlike unions, Rust enums are type-safe.

Enums are useful whenever a value might be either one thing or another. The “price” of using them is that you must access the data safely, using pattern matching, our topic for the second half of this chapter.

Patterns, too, may be familiar if you've used unpacking in Python or destructuring in JavaScript, but Rust takes patterns further. Rust patterns are a little like regular expressions for all your data. They're used to test whether or not a value has a particular desired shape. They can extract several fields from a struct or tuple into local

variables all at once. And like regular expressions, they are concise, typically doing it all in a single line of code.

## Enums

Simple, C-style enums are straightforward:

```
enum Ordering {
    Less,
    Equal,
    Greater
}
```

This declares a type `Ordering` with three possible values, called *variants* or *constructors*: `Ordering::Less`, `Ordering::Equal`, and `Ordering::Greater`. This particular enum is part of the standard library, so Rust code can import it, either by itself:

```
use std::cmp::Ordering;

fn compare(n: i32, m: i32) -> Ordering {
    if n < m {
        Ordering::Less
    } else if n > m {
        Ordering::Greater
    } else {
        Ordering::Equal
    }
}
```

or with all its constructors:

```
use std::cmp::Ordering;
use std::cmp::Ordering::*; // `*` to import all children

fn compare(n: i32, m: i32) -> Ordering {
    if n < m {
        Less
    } else if n > m {
        Greater
    } else {
        Equal
    }
}
```

After importing the constructors, we can write `Less` instead of `Ordering::Less`, and so on, but because this is less explicit, it's generally considered better style *not* to import them except when it makes your code much more readable.

To import the constructors of an enum declared in the current module, use a `self` import:

```
enum Pet {
    Orca,
    Giraffe,
    ...
}

use self::Pet::*;
```

In memory, values of C-style enums are stored as integers. Occasionally it's useful to tell Rust which integers to use:

```
enum HttpStatus {
    Ok = 200,
    NotModified = 304,
    NotFound = 404,
    ...
}
```

Otherwise Rust will assign the numbers for you, starting at 0.

By default, Rust stores C-style enums using the smallest built-in integer type that can accommodate them. Most fit in a single byte.

```
use std::mem::size_of;
assert_eq!(size_of:::<Ordering>(), 1);
assert_eq!(size_of:::<HttpStatus>(), 2); // 404 doesn't fit in a u8
```

You can override Rust's choice of in-memory representation by adding a `#[repr]` attribute to the enum. For details, see [Chapter 21](#).

Casting a C-style enum to an integer is allowed:

```
assert_eq!(HttpStatus::Ok as i32, 200);
```

However, casting in the other direction, from the integer to the enum, is not. Unlike C and C++, Rust guarantees that an enum value is only ever one of the values spelled out in the enum declaration. An unchecked cast from an integer type to an enum type could break this guarantee, so it's not allowed. You can either write your own checked conversion:

```
fn http_status_from_u32(n: u32) -> Option<HttpStatus> {
    match n {
        200 => Some(HttpStatus::Ok),
        304 => Some(HttpStatus::NotModified),
        404 => Some(HttpStatus::NotFound),
        ...
        _ => None
    }
}
```

or use the [enum\\_primitive crate](#). It contains a macro that autogenerates this kind of conversion code for you.

As with structs, the compiler will implement features like the == operator for you, but you have to ask.

```
#[derive(Copy, Clone, Debug, PartialEq)]
enum TimeUnit {
    Seconds, Minutes, Hours, Days, Months, Years
}
```

Enums can have methods, just like structs:

```
impl TimeUnit {
    /// Return the plural noun for this time unit.
    fn plural(self) -> &'static str {
        match self {
            TimeUnit::Seconds => "seconds",
            TimeUnit::Minutes => "minutes",
            TimeUnit::Hours => "hours",
            TimeUnit::Days => "days",
            TimeUnit::Months => "months",
            TimeUnit::Years => "years"
        }
    }

    /// Return the singular noun for this time unit.
    fn singular(self) -> &'static str {
        self.plural().trim_right_matches('s')
    }
}
```

So much for C-style enums. The more interesting sort of Rust enum is the kind that contains data.

## Enums with Data

Some programs always need to display full dates and times down to the millisecond, but for most applications, it's more user-friendly to use a rough approximation, like “two months ago.” We can write an enum to help with that:

```
/// A timestamp that has been deliberately rounded off, so our program
/// says "6 months ago" instead of "February 9, 2016, at 9:49 AM".
#[derive(Copy, Clone, Debug, PartialEq)]
enum RoughTime {
    InThePast(TimeUnit, u32),
    JustNow,
    InTheFuture(TimeUnit, u32)
}
```

Two of the variants in this enum, `InThePast` and `InTheFuture`, take arguments. These are called *tuple variants*. Like tuple structs, these constructors are functions that create new `RoughTime` values.

```
let four_score_and_seven_years_ago =  
    RoughTime::InThePast(TimeUnit::Years, 4*20 + 7);  
  
let three_hours_from_now =  
    RoughTime::InTheFuture(TimeUnit::Hours, 3);
```

Enums can also have *struct variants*, which contain named fields, just like ordinary structs:

```
enum Shape {  
    Sphere { center: Point3d, radius: f32 },  
    Cuboid { corner1: Point3d, corner2: Point3d }  
}  
  
let unit_sphere = Shape::Sphere { center: ORIGIN, radius: 1.0 };
```

In all, Rust has three kinds of enum variant, echoing the three kinds of struct we showed in the previous chapter. Variants with no data correspond to unit-like structs. Tuple variants look and function just like tuple structs. Struct variants have curly braces and named fields. A single enum can have variants of all three kinds.

```
enum RelationshipStatus {  
    Single,  
    InARelationship,  
    ItsComplicated(Option<String>),  
    ItsExtremelyComplicated {  
        car: DifferentialEquation,  
        cdr: EarlyModernistPoem  
    }  
}
```

All constructors and fields of a public enum are automatically public.

## Enums in Memory

In memory, enums with data are stored as a small integer *tag*, plus enough memory to hold all the fields of the largest variant. The tag field is for Rust's internal use. It tells which constructor created the value, and therefore which fields it has.

As of Rust 1.17, `RoughTime` fits in 8 bytes, as shown in [Figure 10-1](#).

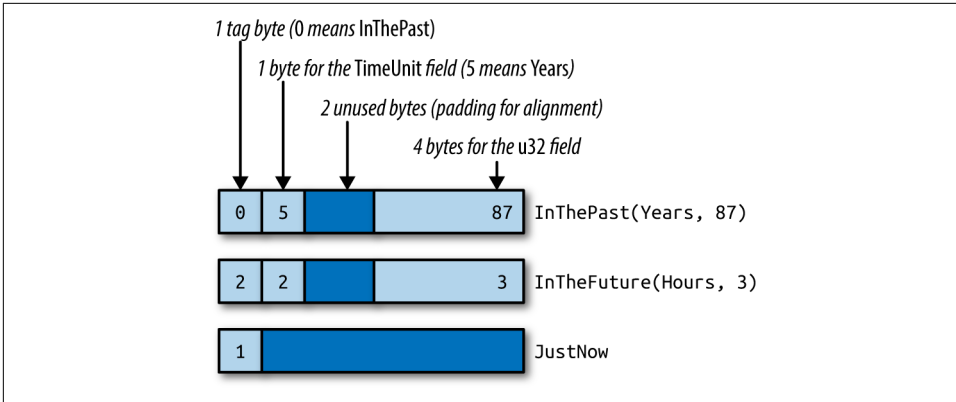

Figure 10-1. *RoughTime* values in memory

Rust makes no promises about enum layout, however, in order to leave the door open for future optimizations. In some cases, it would be possible to pack an enum more efficiently than the figure suggests. We'll show later in this chapter how Rust can already optimize away the tag field for some enums.

## Rich Data Structures Using Enums

Enums are also useful for quickly implementing tree-like data structures. For example, suppose a Rust program needs to work with arbitrary JSON data. In memory, any JSON document can be represented as a value of this Rust type:

```
enum Json {
    Null,
    Boolean(bool),
    Number(f64),
    String(String),
    Array(Vec<Json>),
    Object(Box<HashMap<String, Json>>)
}
```

The explanation of this data structure in English can't improve much upon the Rust code. The JSON standard specifies the various data types that can appear in a JSON document: `null`, Boolean values, numbers, strings, arrays of JSON values, and objects with string keys and JSON values. The `Json` enum simply spells out these types.

This is not a hypothetical example. A very similar enum can be found in `serde_json`, a serialization library for Rust structs that is one of the most-downloaded crates on [crates.io](https://crates.io).

The `Box` around the `HashMap` that represents an `Object` serves only to make all `Json` values more compact. In memory, values of type `Json` take up four machine words. `String` and `Vec` values are three words, and Rust adds a tag byte. `Null` and `Boolean`

values don't have enough data in them to use up all that space, but all `Json` values must be the same size. The extra space goes unused. [Figure 10-2](#) shows some examples of how `Json` values actually look in memory.

A `HashMap` is larger still. If we had to leave room for it in every `Json` value, they would be quite large, eight words or so. But a `Box<HashMap>` is a single word: it's just a pointer to heap-allocated data. We could make `Json` even more compact by boxing more fields.

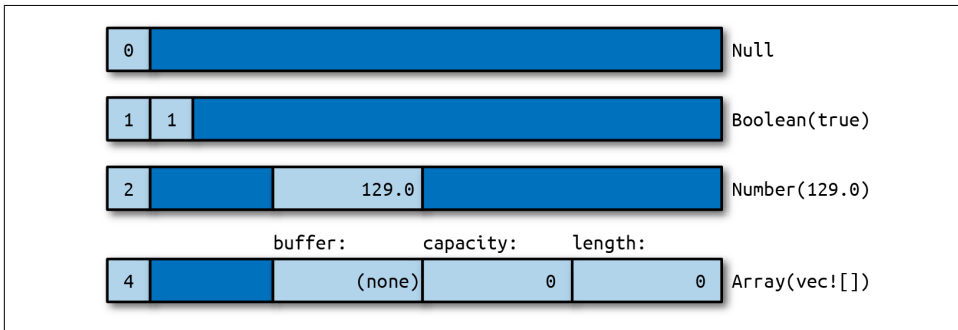

*Figure 10-2. `Json` values in memory*

What's remarkable here is how easy it was to set this up. In C++, one might write a class for this:

```
class JSON {
private:
    enum Tag {
        Null, Boolean, Number, String, Array, Object
    };
    union Data {
        bool boolean;
        double number;
        shared_ptr<string> str;
        shared_ptr<vector<JSON>> array;
        shared_ptr<unordered_map<string, JSON>> object;

        Data() {}
        ~Data() {}
        ...
    };

    Tag tag;
    Data data;

public:
    bool is_null() const { return tag == Null; }
    bool is_boolean() const { return tag == Boolean; }
    bool get_boolean() const {
```

```

        assert(is_boolean());
        return data.boolean;
    }
    void set_boolean(bool value) {
        this->~JSON(); // clean up string/array/object value
        tag = Boolean;
        data.boolean = value;
    }
    ...
};

```

At 30 lines of code, we have barely begun the work. This class will need constructors, a destructor, and an assignment operator. An alternative would be to create a class hierarchy with a base class `JSON` and subclasses `JSONBoolean`, `JSONString`, and so on. Either way, when it's done, our C++ JSON library will have more than a dozen methods. It will take a bit of reading for other programmers to pick it up and use it. The entire Rust enum is eight lines of code.

## Generic Enums

Enums can be generic. Two examples from the standard library are among the most-used data types in the language:

```

enum Option<T> {
    None,
    Some(T)
}

enum Result<T, E> {
    Ok(T),
    Err(E)
}

```

These types are familiar enough by now, and the syntax for generic enums is the same as for generic structs. One unobvious detail is that Rust can eliminate the tag field of `Option<T>` when the type `T` is a `Box` or some other smart pointer type. An `Option<Box<i32>>` is stored in memory as a single machine word, 0 for `None` and nonzero for `Some` boxed value.

Generic data structures can be built with just a few lines of code:

```

// An ordered collection of `T`s.
enum BinaryTree<T> {
    Empty,
    NonEmpty(Box<TreeNode<T>>)
}

// A part of a BinaryTree.
struct TreeNode<T> {
    element: T,
    left: BinaryTree<T>,

```



```

    right: BinaryTree<T>
}

```

These few lines of code define a `BinaryTree` type that can store any number of values of type `T`.

A great deal of information is packed into these two definitions, so we will take the time to translate the code word for word into English. Each `BinaryTree` value is either `Empty` or `NonEmpty`. If it's `Empty`, then it contains no data at all. If `NonEmpty`, then it has a `Box`, a pointer to a heap-allocated `TreeNode`.

Each `TreeNode` value contains one actual element, as well as two more `BinaryTree` values. This means a tree can contain subtrees, and thus a `NonEmpty` tree can have any number of descendants.

A sketch of a value of type `BinaryTree<&str>` is shown in [Figure 10-3](#). As with `Option<Box<T>>`, Rust eliminates the tag field, so a `BinaryTree` value is just one machine word.

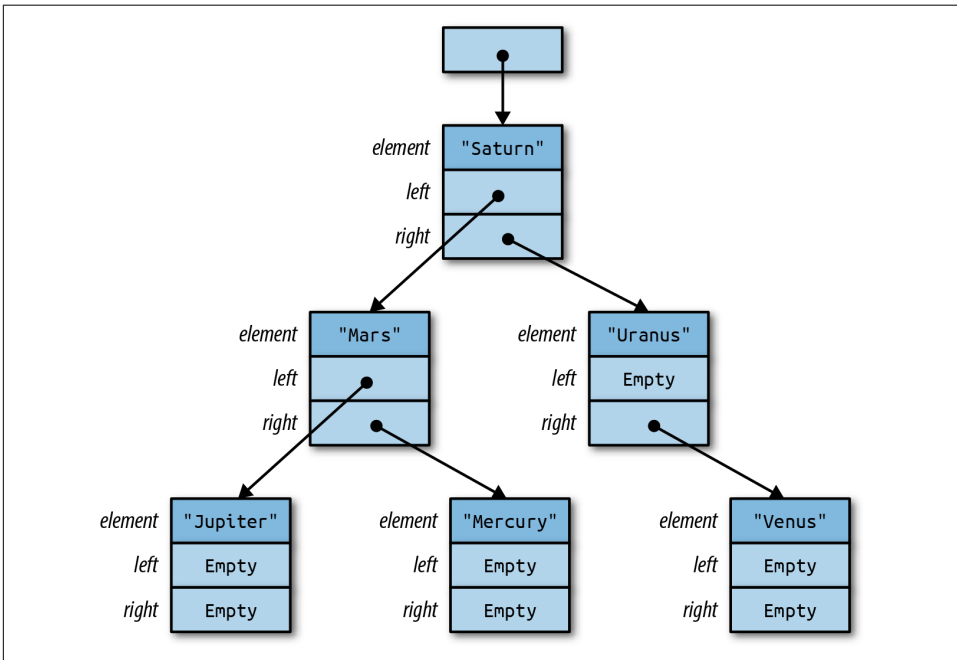

Figure 10-3. A `BinaryTree` containing six strings

Building any particular node in this tree is straightforward:

```

use self::BinaryTree::*;
let jupiter_tree = NonEmpty(Box::new(TreeNode {
    element: "Jupiter",

```

```

    left: Empty,
    right: Empty
  }));

```

Larger trees can be built from smaller ones:

```

let mars_tree = NonEmpty(Box::new(TreeNode {
  element: "Mars",
  left: jupiter_tree,
  right: mercury_tree
}));

```

Naturally, this assignment transfers ownership of `jupiter_node` and `mercury_node` to their new parent node.

The remaining parts of the tree follow the same patterns. The root node is no different from the others:

```

let tree = NonEmpty(Box::new(TreeNode {
  element: "Saturn",
  left: mars_tree,
  right: uranus_tree
}));

```

Later in this chapter, we'll show how to implement an `add` method on the `BinaryTree` type, so that we can instead write:

```

let mut tree = BinaryTree::Empty;
for planet in planets {
  tree.add(planet);
}

```

No matter what language you're coming from, creating data structures like `BinaryTree` in Rust will likely take some practice. It won't be obvious at first where to put the Boxes. One way to find a design that will work is to draw a picture like [Figure 10-3](#) that shows how you want things laid out in memory. Then work backward from the picture to the code. Each collection of rectangles is a struct or tuple; each arrow is a `Box` or other smart pointer. Figuring out the type of each field is a bit of a puzzle, but a manageable one. The reward for solving the puzzle is control over your program's memory usage.

Now comes the “price” we mentioned in the introduction. The tag field of an enum costs a little memory, up to 8 bytes in the worst case, but that is usually negligible. The real downside to enums (if it can be called that) is that Rust code cannot throw caution to the wind and try to access fields regardless of whether they are actually present in the value:

```

let r = shape.radius; // error: no field `radius` on type `Shape`

```

The only way to access the data in an enum is the safe way: using patterns.

# Patterns

Recall the definition of our `RoughTime` type from earlier in this chapter:

```
enum RoughTime {
    InThePast(TimeUnit, u32),
    JustNow,
    InTheFuture(TimeUnit, u32)
}
```

Suppose you have a `RoughTime` value and you'd like to display it on a web page. You need to access the `TimeUnit` and `u32` fields inside the value. Rust doesn't let you access them directly, by writing `rough_time.0` and `rough_time.1`, because after all, the value might be `RoughTime::JustNow`, which has no fields. But then, how can you get the data out?

You need a match expression:

```
1 fn rough_time_to_english(rt: RoughTime) -> String {
2     match rt {
3         RoughTime::InThePast(units, count) =>
4             format!("{ } ago", count, units.plural()),
5         RoughTime::JustNow =>
6             format!("just now"),
7         RoughTime::InTheFuture(units, count) =>
8             format!("{ } from now", count, units.plural())
9     }
10 }
```

`match` performs pattern matching; in this example, the *patterns* are the parts that appear before the `=>` symbol on lines 3, 5, and 7. Patterns that match `RoughTime` values look just like the expressions used to create `RoughTime` values. This is no coincidence. Expressions *produce* values; patterns *consume* values. The two use a lot of the same syntax.

Let's step through what happens when this match expression runs. Suppose `rt` is the value `RoughTime::InTheFuture(TimeUnit::Months, 1)`. Rust first tries to match this value against the pattern on line 3. As you can see in [Figure 10-4](#), it doesn't match.

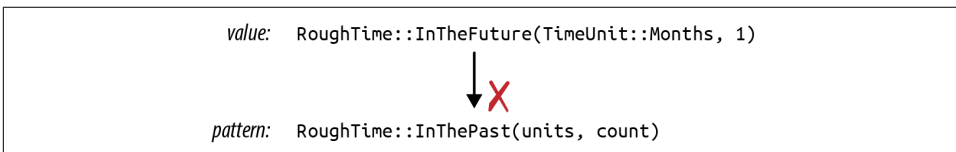

Figure 10-4. A `RoughTime` value and pattern that do not match

Pattern matching on an enum, struct, or tuple works as though Rust is doing a simple left-to-right scan, checking each component of the pattern to see if the value matches it. If it doesn't, Rust moves on to the next pattern.

The patterns on lines 3 and 5 fail to match. But the pattern on line 7 succeeds (Figure 10-5).

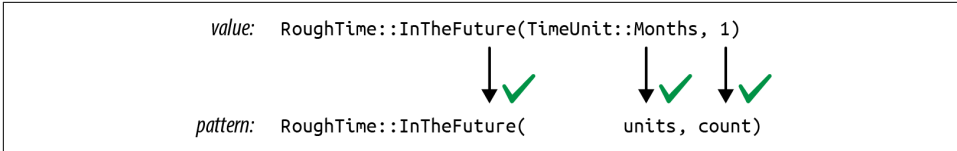

Figure 10-5. A successful match

When a pattern contains simple identifiers like `units` and `count`, those become local variables in the code following the pattern. Whatever is present in the value is copied or moved into the new variables. Rust stores `TimeUnit::Months` in `units` and `1` in `count`, runs line 8, and returns the string `"1 months from now"`.

That output has a minor grammatical issue, which can be fixed by adding another arm to the match:

```
RoughTime::InTheFuture(unit, 1) =>
    format!("a {} from now", unit.singular()),
```

This arm matches only if the `count` field is exactly `1`. Note that this new code must be added before line 7. If we add it at the end, Rust will never get to it, because the pattern on line 7 matches all `InTheFuture` values. The Rust compiler will warn about an “unreachable pattern” if you make this kind of mistake.

Unfortunately, even with the new code, there is still a problem with `RoughTime::InTheFuture(TimeUnit::Hours, 1)`: the result `"a hour from now"` is not quite right. Such is the English language. This too can be fixed by adding another arm to the match.

As this example shows, pattern matching works hand in hand with enums and can even test the data they contain, making `match` a powerful, flexible replacement for C’s `switch` statement.

So far, we’ve only seen patterns that match enum values. There’s more to it than that. Rust patterns are their own little language, summarized in Table 10-1. We’ll spend most of the rest of the chapter on the features shown in this table.

Table 10-1. Patterns

Pattern type	Example	Notes
Literal	100 "name"	Matches an exact value; the name of a <code>const</code> is also allowed
Range	0 ... 100 'a' ... 'k'	Matches any value in range, including the end value
Wildcard	_	Matches any value and ignores it
Variable	name mut count	Like <code>_</code> but moves or copies the value into a new local variable
ref variable	ref field ref mut field	Borrows a reference to the matched value instead of moving or copying it
Binding with subpattern	val @ 0 ... 99 ref circle @ Shape::Circle { .. }	Matches the pattern to the right of <code>@</code> , using the variable name to the left
Enum pattern	Some(value) None Pet::Orca	
Tuple pattern	(key, value) (r, g, b)	
Struct pattern	Color(r, g, b) Point { x, y } Card { suit: Clubs, rank: n } Account { id, name, .. }	
Reference	&value &(k, v)	Matches only reference values
Multiple patterns	'a'   'A'	In match only (not valid in <code>let</code> , etc.)
Guard expression	x if x * x <= r2	In match only (not valid in <code>let</code> , etc.)

## Literals, Variables, and Wildcards in Patterns

So far, we've shown `match` expressions working with enums. Other types can be matched too. When you need something like a C `switch` statement, use `match` with an integer value. Integer literals like `0` and `1` can serve as patterns:

```
match meadow.count_rabbits() {
    0 => {} // nothing to say
    1 => println!("A rabbit is nosing around in the clover."),
    n => println!("There are {} rabbits hopping about in the meadow", n)
}
```

The pattern `0` matches if there are no rabbits in the meadow. `1` matches if there is just one. If there are two or more rabbits, we reach the third pattern, `n`. This pattern is just a variable name. It can match any value, and the matched value is moved or copied into a new local variable. So in this case, the value of `meadow.count_rabbits()` is stored in a new local variable `n`, which we then print.

Other literals can be used as patterns too, including Booleans, characters, and even strings:

```
let calendar =
    match settings.get_string("calendar") {
        "gregorian" => Calendar::Gregorian,
        "chinese" => Calendar::Chinese,
        "ethiopian" => Calendar::Ethiopian,
        other => return parse_error("calendar", other)
    };
```

In this example, `other` serves as a catch-all pattern, like `n` in the previous example. These patterns play the same role as a default case in a switch statement, matching values that don't match any of the other patterns.

If you need a catch-all pattern, but you don't care about the matched value, you can use a single underscore `_` as a pattern, the *wildcard pattern*:

```
let caption =
    match photo.tagged_pet() {
        Pet::Tyrannosaur => "RRRAAAAHHHHHH",
        Pet::Samoyed => "*dog thoughts*",
        _ => "I'm cute, love me" // generic caption, works for any pet
    };
```

The wildcard pattern matches any value, but without storing it anywhere. Since Rust requires every `match` expression to handle all possible values, a wildcard is often required at the end. Even if you're very sure the remaining cases can't occur, you must at least add a fallback arm that panics:

```
// There are many Shapes, but we only support "selecting"
// either some text, or everything in a rectangular area.
// You can't select an ellipse or trapezoid.
match document.selection() {
    Shape::TextSpan(start, end) => paint_text_selection(start, end),
    Shape::Rectangle(rect) => paint_rect_selection(rect),
    _ => panic!("unexpected selection type")
}
```

It's worth noting that existing variables can't be used in patterns. Suppose we're implementing a board game with hexagonal spaces, and the player just clicked to move a piece. To confirm that the click was valid, we might try something like this:

```
fn check_move(current_hex: Hex, click: Point) -> game::Result<Hex> {
    match point_to_hex(click) {
```

```

None =>
    Err("That's not a game space."),
Some(current_hex) => // try to match if user clicked the current_hex
                    // (it doesn't work: see explanation below)
    Err("You are already there! You must click somewhere else."),
Some(other_hex) =>
    Ok(other_hex)
}
}

```

This fails because identifiers in patterns introduce *new* variables. The pattern `Some(current_hex)` here creates a new local variable `current_hex`, shadowing the argument `current_hex`. Rust emits several warnings about this code—in particular, the last arm of the match is unreachable. To fix it, use an `if` expression:

```

Some(hex) =>
    if hex == current_hex {
        Err("You are already there! You must click somewhere else")
    } else {
        Ok(hex)
    }
}

```

In a few pages, we'll cover **guards**, which offer another way to solve this problem.

## Tuple and Struct Patterns

Tuple patterns match tuples. They're useful any time you want to get multiple pieces of data involved in a single match:

```

fn describe_point(x: i32, y: i32) -> &'static str {
    use std::cmp::Ordering::*;
    match (x.cmp(&0), y.cmp(&0)) {
        (Equal, Equal) => "at the origin",
        (_, Equal) => "on the x axis",
        (Equal, _) => "on the y axis",
        (Greater, Greater) => "in the first quadrant",
        (Less, Greater) => "in the second quadrant",
        _ => "somewhere else"
    }
}

```

Struct patterns use curly braces, just like struct expressions. They contain a subpattern for each field:

```

match balloon.location {
    Point { x: 0, y: height } =>
        println!("straight up {} meters", height),
    Point { x: x, y: y } =>
        println!("at ({}m, {}m)", x, y)
}

```

In this example, if the first arm matches, then `balloon.location.y` is stored in the new local variable `height`.

Suppose `balloon.location` is `Point { x: 30, y: 40 }`. As always, Rust checks each component of each pattern in turn [Figure 10-6](#).

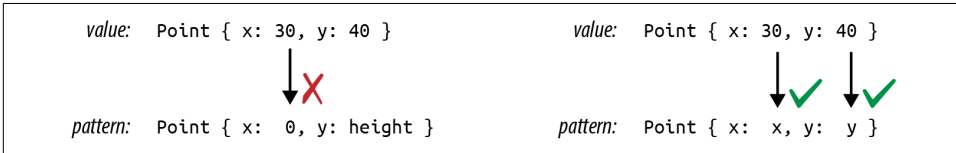

Figure 10-6. Pattern matching with structs

The second arm matches, so the output would be “at (30m, 40m)”.

Patterns like `Point { x: x, y: y }` are common when matching structs, and the redundant names are visual clutter, so Rust has a shorthand for this: `Point {x, y}`. The meaning is the same. This pattern still stores a point’s `x` field in a new local `x` and its `y` field in a new local `y`.

Even with the shorthand, it is cumbersome to match a large struct when we only care about a few fields:

```
match get_account(id) {
    ...
    Some(Account {
        name, language, // <--- the 2 things we care about
        id: _, status: _, address: _, birthday: _, eye_color: _,
        pet: _, security_question: _, hashed_innermost_secret: _,
        is_adamantium_preferred_customer: _ }) =>
        language.show_custom_greeting(name)
}
```

To avoid this, use `..` to tell Rust you don’t care about any of the other fields:

```
Some(Account { name, language, .. }) =>
    language.show_custom_greeting(name)
```

## Reference Patterns

Rust patterns support two features for working with references. `ref` patterns borrow parts of a matched value. `&` patterns match references. We’ll cover `ref` patterns first.

Matching on a noncopyable value moves the value. Continuing with the account example, this code would be invalid:

```
match account {
    Account { name, language, .. } => {
        ui.greet(&name, &language);
        ui.show_settings(&account); // error: use of moved value `account`
    }
}
```



```
    }  
}
```

Here, the fields `account.name` and `account.language` are moved into local variables `name` and `language`. The rest of `account` is dropped. That's why we can't call methods on `account` afterward.

If `name` and `language` were both copyable values, Rust would copy the fields instead of moving them, and this code would be fine. But suppose these are `Strings`. What can we do?

We need a kind of pattern that *borrow*s matched values instead of moving them. The `ref` keyword does just that:

```
match account {  
    Account { ref name, ref language, .. } => {  
        ui.greet(name, language);  
        ui.show_settings(&account); // ok  
    }  
}
```

Now the local variables `name` and `language` are references to the corresponding fields in `account`. Since `account` is only being borrowed, not consumed, it's OK to continue calling methods on it.

You can use `ref mut` to borrow `mut` references:

```
match line_result {  
    Err(ref err) => log_error(err), // `err` is &Error (shared ref)  
    Ok(ref mut line) => {           // `line` is &mut String (mut ref)  
        trim_comments(line);      // modify the String in place  
        handle(line);  
    }  
}
```

The pattern `Ok(ref mut line)` matches any success result and borrows a `mut` reference to the success value stored inside it.

The opposite kind of reference pattern is the `&` pattern. A pattern starting with `&` matches a reference.

```
match sphere.center() {  
    &Point3d { x, y, z } => ...  
}
```

In this example, suppose `sphere.center()` returns a reference to a private field of `sphere`, a common pattern in Rust. The value returned is the address of a `Point3d`. If the center is at the origin, then `sphere.center()` returns `&Point3d { x: 0.0, y: 0.0, z: 0.0 }`.

So pattern matching proceeds as shown in [Figure 10-7](#).

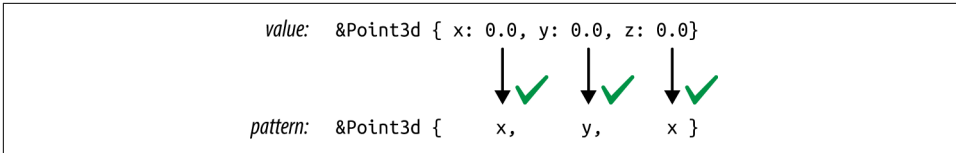

Figure 10-7. Pattern matching with references

This is a bit tricky because Rust is following a pointer here, an action we usually associate with the `*` operator, not the `&` operator. The thing to remember is that patterns and expressions are natural opposites. The expression `(x, y)` makes two values into a new tuple, but the pattern `(x, y)` does the opposite: it matches a tuple and breaks out the two values. It's the same with `&`. In an expression, `&` creates a reference. In a pattern, `&` matches a reference.

Matching a reference follows all the rules we've come to expect. Lifetimes are enforced. You can't get `mut` access via a shared reference. And you can't move a value out of a reference, even a `mut` reference. When we match `&Point3d { x, y, z }`, the variables `x`, `y`, and `z` receive copies of the coordinates, leaving the original `Point3d` value intact. It works because those fields are copyable. If we try the same thing on a struct with noncopyable fields, we'll get an error:

```

match friend.borrow_car() {
    Some(&Car { engine, .. }) => // error: can't move out of borrow
    ...
    None => {}
}

```

Scrapping a borrowed car for parts is not nice, and Rust won't stand for it. You can use a `ref` pattern to borrow a reference to a part. You just don't own it.

```

Some(&Car { ref engine, .. }) => // ok, engine is a reference

```

Let's look at one more example of an `&` pattern. Suppose we have an iterator `chars` over the characters in a string, and it has a method `chars.peek()` that returns an `Option<&char>`: a reference to the next character, if any. (Peekable iterators do in fact return an `Option<&ItemType>`, as we'll see in [Chapter 15](#).)

A program can use an `&` pattern to get the pointed-to character:

```

match chars.peek() {
    Some(&c) => println!("coming up: {:?}", c),
    None => println!("end of chars")
}

```

## Matching Multiple Possibilities

The vertical bar (|) can be used to combine several patterns in a single match arm:

```
let at_end =
    match chars.peek() {
        Some(&'r') | Some(&'n') | None => true,
        _ => false
    };
```

In an expression, | is the bitwise OR operator, but here it works more like the | symbol in a regular expression. `at_end` is set to `true` if `chars.peek()` matches any of the three patterns.

Use `...` to match a whole range of values. Range patterns include the begin and end values, so `'0' ... '9'` matches all the ASCII digits:

```
match next_char {
    '0' ... '9' =>
        self.read_number(),
    'a' ... 'z' | 'A' ... 'Z' =>
        self.read_word(),
    ' ' | '\t' | '\n' =>
        self.skip_whitespace(),
    _ =>
        self.handle_punctuation()
}
```

Ranges in patterns are *inclusive*, so that both `'0'` and `'9'` match the pattern `'0' ... '9'`. By contrast, range expressions (written with two dots, as in `for n in 0..100`) are half-open, or *exclusive* (covering 0 but not 100). The reason for the inconsistency is simply that exclusive ranges are more useful for loops and slicing, but inclusive ranges are more useful in pattern matching.

## Pattern Guards

Use the `if` keyword to add a *guard* to a match arm. The match succeeds only if the guard evaluates to `true`:

```
match robot.last_known_location() {
    Some(point) if self.distance_to(point) < 10 =>
        short_distance_strategy(point),
    Some(point) =>
        long_distance_strategy(point),
    None =>
        searching_strategy()
}
```

If a pattern moves any values, you can't put a guard on it. The guard might evaluate to `false`, and then Rust would go on to the next pattern. But it can't do that if you've

moved bits out of the value to be matched. Therefore, the preceding code works only if `point` is **copyable**. If it's not, we'll get an error:

```
error[E0008]: cannot bind by-move into a pattern guard
--> enums_move_into_guard.rs:19:18
   |
19 |         Some(point) if self.distance_to(point) < 10 =>
   |                        ^^^^^ moves value into pattern guard
```

The workaround, then, would be to change the pattern to borrow `point` instead of moving it: `Some(ref point)`.

## @ patterns

Finally, `x @ pattern` matches exactly like the given *pattern*, but on success, instead of creating variables for parts of the matched value, it creates a single variable `x` and moves or copies the whole value into it. For example, say you have this code:

```
match self.get_selection() {
    Shape::Rect(top_left, bottom_right) =>
        optimized_paint(&Shape::Rect(top_left, bottom_right)),
    other_shape =>
        paint_outline(other_shape.get_outline()),
}
```

Note that the first case unpacks a `Shape::Rect` value, only to rebuild an identical `Shape::Rect` value on the next line. This can be rewritten to use an `@` pattern:

```
rect @ Shape::Rect(..) =>
    optimized_paint(&rect),
```

`@` patterns are also useful with ranges:

```
match chars.next() {
    Some(digit @ '0' ... '9') => read_number(digit, chars),
    ...
}
```

## Where Patterns Are Allowed

Although patterns are most prominent in `match` expressions, they are also allowed in several other places, typically in place of an identifier. The meaning is always the same: instead of just storing a value in a single variable, Rust uses pattern matching to take the value apart.

This means patterns can be used to...

```
// ...unpack a struct into three new local variables
let Track { album, track_number, title, .. } = song;

// ...unpack a function argument that's a tuple
fn distance_to((x, y): (f64, f64)) -> f64 { ... }
```

```

// ...iterate over keys and values of a HashMap
for (id, document) in &cache_map {
    println!("Document #{}: {}", id, document.title);
}

// ...automatically dereference an argument to a closure
// (handy because sometimes other code passes you a reference
// when you'd rather have a copy)
let sum = numbers.fold(0, |a, &num| a + num);

```

Each of these saves two or three lines of boilerplate code. The same concept exists in some other languages: in JavaScript, it's called *destructuring*; in Python, *unpacking*.

Note that in all four examples, we use patterns that are guaranteed to match. The pattern `Point3d { x, y, z }` matches every possible value of the `Point3d` struct type; `(x, y)` matches any `(f64, f64)` pair; and so on. Patterns that always match are special in Rust. They're called *irrefutable patterns*, and they're the only patterns allowed in the four places shown here (after `let`, in function arguments, after `for`, and in closure arguments).

A *refutable pattern* is one that might not match, like `Ok(x)`, which doesn't match an error result, or `'0' ... '9'`, which doesn't match the character `'Q'`. Refutable patterns can be used in `match` arms, because `match` is designed for them: if one pattern fails to match, it's clear what happens next. The four examples above are places in Rust programs where a pattern can be handy, but the language doesn't allow for match failure.

Refutable patterns are also allowed in `if let` and `while let` expressions, which can be used to...

```

// ...handle just one enum variant specially
if let RoughTime::InTheFuture(_, _) = user.date_of_birth() {
    user.set_time_traveler(true);
}

// ...run some code only if a table lookup succeeds
if let Some(document) = cache_map.get(&id) {
    return send_cached_response(document);
}

// ...repeatedly try something until it succeeds
while let Err(err) = present_cheesy_anti_robot_task() {
    log_robot_attempt(err);
    // let the user try again (it might still be a human)
}

// ...manually loop over an iterator
while let Some(_) = lines.peek() {

```

```
        read_paragraph(&mut lines);
    }
```

For details about these expressions, see “if let” on page 129 and “Loops” on page 130.

## Populating a Binary Tree

Earlier we promised to show how to implement a method, `BinaryTree::add()`, that adds a node to a `BinaryTree` of this type:

```
enum BinaryTree<T> {
    Empty,
    NonEmpty(Box<TreeNode<T>>)
}

struct TreeNode<T> {
    element: T,
    left: BinaryTree<T>,
    right: BinaryTree<T>
}
```

You now know enough about patterns to write this method. An explanation of binary search trees is beyond the scope of this book, but for readers already familiar with the topic, it’s worth seeing how it plays out in Rust.

```
1 impl<T: Ord> BinaryTree<T> {
2     fn add(&mut self, value: T) {
3         match *self {
4             BinaryTree::Empty =>
5                 *self = BinaryTree::NonEmpty(Box::new(TreeNode {
6                     element: value,
7                     left: BinaryTree::Empty,
8                     right: BinaryTree::Empty
9                 })),
10            BinaryTree::NonEmpty(ref mut node) =>
11                if value <= node.element {
12                    node.left.add(value);
13                } else {
14                    node.right.add(value);
15                }
16        }
17    }
18 }
```

Line 1 tells Rust that we’re defining a method on `BinaryTrees` of ordered types. This is exactly the same syntax we use to define methods on generic structs, explained in “Defining Methods with `impl`” on page 198.

If the existing tree `*self` is empty, that’s the easy case. Lines 5–9 run, changing the Empty tree to a NonEmpty one. The call to `Box::new()` here allocates a new `TreeNode`

in the heap. When we're done, the tree contains one element. Its left and right subtrees are both `Empty`.

If `*self` is not empty, we match the pattern on line 10:

```
BinaryTree::NonEmpty(ref mut node) =>
```

This pattern borrows a mutable reference to the `Box<TreeNode<T>>`, so we can access and modify data in that tree node. That reference is named `node`, and it's in scope from line 11 to line 15. Since there's already an element in this node, the code must recursively call `.add()` to add the new element to either the left or the right subtree.

The new method can be used like this:

```
let mut tree = BinaryTree::Empty;
tree.add("Mercury");
tree.add("Venus");
...
```

## The Big Picture

Rust's enums may be new to systems programming, but they are not a new idea. Traveling under various academic-sounding names, like *algebraic data types*, they've been used in functional programming languages for more than 40 years. It's unclear why so few other languages in the C tradition have ever had them. Perhaps it is simply that for a programming language designer, combining variants, references, mutability, and memory safety is extremely challenging. Functional programming languages dispense with mutability. C unions, by contrast, have variants, pointers, and mutability—but are so spectacularly unsafe that even in C, they're a last resort. Rust's borrow checker is the magic that makes it possible to combine all four without compromise.

Programming is data processing. Getting data into the right shape can be the difference between a small, fast, elegant program and a slow, gigantic tangle of duct tape and virtual method calls.

This is the problem space enums address. They are a design tool for getting data into the right shape. For cases when a value may be one thing, or another thing, or perhaps nothing at all, enums are better than class hierarchies on every axis: faster, safer, less code, easier to document.

The limiting factor is flexibility. End users of an enum can't extend it to add new variants. Variants can be added only by changing the enum declaration. And when that happens, existing code breaks. Every `match` expression that individually matches each variant of the enum must be revisited—it needs a new arm to handle the new variant. In some cases, trading flexibility for simplicity is just good sense. After all, the structure of JSON is not expected to change. And in some cases, revisiting all uses of an enum when it changes is exactly what we want. For example, when an `enum` is used in

a compiler to represent the various operators of a programming language, adding a new operator *should* involve touching all code that handles operators.

But sometimes more flexibility is needed. For those situations, Rust has traits, the topic of our next chapter.



---

# Traits and Generics

*[A] computer scientist tends to be able to deal with nonuniform structures—case 1, case 2, case 3—while a mathematician will tend to want one unifying axiom that governs an entire system.*

— Donald Knuth

One of the great discoveries in programming is that it's possible to write code that operates on values of many different types, *even types that haven't been invented yet*. Here are two examples:

- `Vec<T>` is generic: you can create a vector of any type of value, including types defined in your program that the authors of `Vec` never anticipated.
- Many things have `.write()` methods, including `Files` and `TcpStreams`. Your code can take a writer by reference, any writer, and send data to it. Your code doesn't have to care what type of writer it is. Later, if someone adds a new type of writer, your code will already support it.

Of course, this capability is hardly new with Rust. It's called *polymorphism*, and it was the hot new programming language technology of the 1970s. By now it's effectively universal. Rust supports polymorphism with two related features: traits and generics. These concepts will be familiar to many programmers, but Rust takes a fresh approach inspired by Haskell's typeclasses.

*Traits* are Rust's take on interfaces or abstract base classes. At first, they look just like interfaces in Java or C#. The trait for writing bytes is called `std::io::Write`, and its definition in the standard library starts out like this:

```
trait Write {
    fn write(&mut self, buf: &[u8]) -> Result<usize>;
    fn flush(&mut self) -> Result<()>;
}
```

```

    fn write_all(&mut self, buf: &[u8]) -> Result<> { ... }
    ...
}

```

This trait offers several methods; we’ve shown only the first three.

The standard types `File` and `TcpStream` both implement `std::io::Write`. So does `Vec<u8>`. All three types provide methods named `.write()`, `.flush()`, and so on. Code that uses a writer without caring about its type looks like this:

```

use std::io::Write;

fn say_hello(out: &mut Write) -> std::io::Result<> {
    out.write_all(b"hello world\n");
    out.flush()
}

```

The type of `out` is `&mut Write`, meaning “a mutable reference to any value that implements the `Write` trait.”

```

use std::fs::File;
let mut local_file = File::create("hello.txt");
say_hello(&mut local_file); // works

let mut bytes = vec![];
say_hello(&mut bytes); // also works
assert_eq!(bytes, b"hello world\n");

```

This chapter begins by showing how traits are used, how they work, and how to define your own. But there is more to traits than we’ve hinted at so far. We’ll use them to add extension methods to existing types, even built-in types like `str` and `bool`. We’ll explain why adding a trait to a type costs no extra memory and how to use traits without virtual method call overhead. We’ll see that built-in traits are the hook into the language that Rust provides for operator overloading and other features. And we’ll cover the `Self` type, associated methods, and associated types, three features Rust lifted from Haskell that elegantly solve problems that other languages address with workarounds and hacks.

*Generics* are the other flavor of polymorphism in Rust. Like a C++ template, a generic function or type can be used with values of many different types.

```

/// Given two values, pick whichever one is less.
fn min<T: Ord>(value1: T, value2: T) -> T {
    if value1 <= value2 {
        value1
    } else {
        value2
    }
}

```

The `<T: Ord>` in this function means that `min` can be used with arguments of any type `T` that implements the `Ord` trait—that is, any ordered type. The compiler generates custom machine code for each type `T` that you actually use.

Generics and traits are closely related. Rust makes us declare the `T: Ord` requirement (called a *bound*) up front, before using the `<=` operator to compare two values of type `T`. So we'll also talk about how `&mut Write` and `<T: Write>` are similar, how they're different, and how to choose between these two ways of using traits.

## Using Traits

A trait is a feature that any given type may or may not support. Most often, a trait represents a capability: something a type can do.

- A value that implements `std::io::Write` can write out bytes.
- A value that implements `std::iter::Iterator` can produce a sequence of values.
- A value that implements `std::clone::Clone` can make clones of itself in memory.
- A value that implements `std::fmt::Debug` can be printed using `println!()` with the `{:?}` format specifier.

These traits are all part of Rust's standard library, and many standard types implement them.

- `std::fs::File` implements the `Write` trait; it writes bytes to a local file. `std::net::TcpStream` writes to a network connection. `Vec<u8>` also implements `Write`. Each `.write()` call on a vector of bytes appends some data to the end.
- `Range<i32>` (the type of `0..10`) implements the `Iterator` trait, as do some iterator types associated with slices, hash tables, and so on.
- Most standard library types implement `Clone`. The exceptions are mainly types like `TcpStream` that represent more than just data in memory.
- Likewise, most standard library types support `Debug`.

There is one unusual rule about trait methods: the trait itself must be in scope. Otherwise, all its methods are hidden.

```
let mut buf: Vec<u8> = vec![];
buf.write_all(b"hello"?); // error: no method named `write_all`
```

In this case, the compiler prints a friendly error message that suggests adding `use std::io::Write`; and indeed that fixes the problem:

```
use std::io::Write;

let mut buf: Vec<u8> = vec![];
buf.write_all(b"hello"?); // ok
```

Rust has this rule because, as we'll see later in this chapter, you can use traits to add new methods to any type—even standard library types like `u32` and `str`. Third-party crates can do the same thing. Clearly, this could lead to naming conflicts! But since Rust makes you import the traits you plan to use, crates are free to take advantage of this superpower, and conflicts are rare in practice.

The reason `Clone` and `Iterator` methods work without any special imports is that they're always in scope by default: they're part of the standard prelude, names that Rust automatically imports into every module. In fact, the prelude is mostly a carefully chosen selection of traits. We'll cover many of them in [Chapter 13](#).

C++ and C# programmers will already have noticed that trait methods are like virtual methods. Still, calls like the one shown above are fast, as fast as any other method call. Simply put, there's no polymorphism here. It's obvious that `buf` is a vector, not a file or a network connection. The compiler can emit a simple call to `Vec<u8>::write()`. It can even inline the method. (C++ and C# will often do the same, although the possibility of subclassing sometimes precludes this.) Only calls through `&mut Write` incur the overhead of a virtual method call.

## Trait Objects

There are two ways of using traits to write polymorphic code in Rust: trait objects and generics. We'll present trait objects first and turn to generics in the next section.

Rust doesn't permit variables of type `Write`:

```
use std::io::Write;

let mut buf: Vec<u8> = vec![];
let writer: Write = buf; // error: `Write` does not have a constant size
```

A variable's size has to be known at compile time, and types that implement `Write` can be any size.

This may be surprising if you're coming from C# or Java, but the reason is simple. In Java, a variable of type `OutputStream` (the Java standard interface analogous to `std::io::Write`) is a reference to any object that implements `OutputStream`. The fact that it's a reference goes without saying. It's the same with interfaces in C# and most other languages.

What we want in Rust is the same thing, but in Rust, references are explicit:

```
let mut buf: Vec<u8> = vec![];
let writer: &mut Write = &mut buf; // ok
```

A reference to a trait type, like `writer`, is called a *trait object*. Like any other reference, a trait object points to some value, it has a lifetime, and it can be either `mut` or `shared`.

What makes a trait object different is that Rust usually doesn't know the type of the referent at compile time. So a trait object includes a little extra information about the referent's type. This is strictly for Rust's own use behind the scenes: when you call `writer.write(data)`, Rust needs the type information to dynamically call the right `write` method depending on the type of `*writer`. You can't query the type information directly, and Rust does not support downcasting from the trait object `&mut Write` back to a concrete type like `Vec<u8>`.

## Trait Object Layout

In memory, a trait object is a fat pointer consisting of a pointer to the value, plus a pointer to a table representing that value's type. Each trait object therefore takes up two machine words, as shown in [Figure 11-1](#).

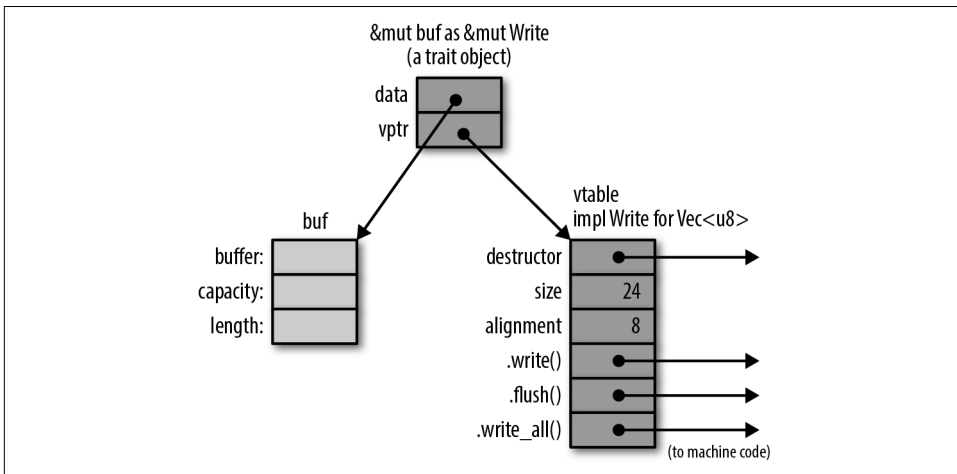

Figure 11-1. Trait objects in memory

C++ has this kind of run-time type information as well. It's called a *virtual table*, or *vtable*. In Rust, as in C++, the vtable is generated once, at compile time, and shared by all objects of the same type. Everything shown in dark gray in [Figure 11-1](#), including the vtable, is a private implementation detail of Rust. Again, these aren't fields and data structures that you can access directly. Instead, the language automatically uses the vtable when you call a method of a trait object, to determine which implementation to call.

Seasoned C++ programmers will notice that Rust and C++ use memory a bit differently. In C++, the vtable pointer, or *vptr*, is stored as part of the struct. Rust uses fat pointers instead. The struct itself contains nothing but its fields. This way, a struct can implement dozens of traits without containing dozens of vptrs. Even types like `i32`, which aren't big enough to accommodate a vptr, can implement traits.

Rust automatically converts ordinary references into trait objects when needed. This is why we're able to pass `&mut local_file` to `say_hello` in this example:

```
let mut local_file = File::create("hello.txt");
say_hello(&mut local_file)?;
```

The type of `&mut local_file` is `&mut File`, and the type of the argument to `say_hello` is `&mut Write`. Since a `File` is a kind of writer, Rust allows this, automatically converting the plain reference to a trait object.

Likewise, Rust will happily convert a `Box<File>` to a `Box<Write>`, a value that owns a writer in the heap:

```
let w: Box<Write> = Box::new(local_file);
```

`Box<Write>`, like `&mut Write`, is a fat pointer: it contains the address of the writer itself and the address of the vtable. The same goes for other pointer types, like `Rc<Write>`.

This kind of conversion is the only way to create a trait object. What the computer is actually doing here is very simple. At the point where the conversion happens, Rust knows the referent's true type (in this case, `File`), so it just adds the address of the appropriate vtable, turning the regular pointer into a fat pointer.

## Generic Functions

At the beginning of this chapter, we showed a `say_hello()` function that took a trait object as an argument. Let's rewrite that function as a generic function:

```
fn say_hello<W: Write>(out: &mut W) -> std::io::Result<> {
    out.write_all(b"hello world\n");
    out.flush()
}
```

Only the type signature has changed:

```
fn say_hello(out: &mut Write)           // plain function

fn say_hello<W: Write>(out: &mut W)     // generic function
```

The phrase `<W: Write>` is what makes the function generic. This is a *type parameter*. It means that throughout the body of this function, `W` stands for some type that implements the `Write` trait. Type parameters are usually single uppercase letters, by convention.

Which type `W` stands for depends on how the generic function is used:

```
say_hello(&mut local_file)?; // calls say_hello::<File>
say_hello(&mut bytes)?;     // calls say_hello::<Vec<u8>>
```

When you pass `&mut local_file` to the generic `say_hello()` function, you're calling `say_hello::<File>()`. Rust generates machine code for this function that calls `File::write_all()` and `File::flush()`. When you pass `&mut bytes`, you're calling `say_hello::<Vec<u8>>()`. Rust generates separate machine code for this version of the function, calling the corresponding `Vec<u8>` methods. In both cases, Rust infers the type `W` from the type of the argument. You can always spell out the type parameters:

```
say_hello::<File>(&mut local_file)?;
```

but it's seldom necessary, because Rust can usually deduce the type parameters by looking at the arguments. Here, the `say_hello` generic function expects a `&mut W` argument, and we're passing it a `&mut File`, so Rust infers that `W = File`.

If the generic function you're calling doesn't have any arguments that provide useful clues, you may have to spell it out:

```
// calling a generic method collect<C>() that takes no arguments
let v1 = (0 .. 1000).collect(); // error: can't infer type
let v2 = (0 .. 1000).collect::<Vec<i32>>(); // ok
```

Sometimes we need multiple abilities from a type parameter. For example, if we want to print out the top 10 most common values in a vector, we'll need for those values to be printable:

```
use std::fmt::Debug;

fn top_ten<T: Debug>(values: &Vec<T>) { ... }
```

But this isn't good enough. How are we planning to determine which values are the most common? The usual way is to use the values as keys in a hash table. That means the values need to support the `Hash` and `Eq` operations. The bounds on `T` must include these as well as `Debug`. The syntax for this uses the `+` sign:

```
fn top_ten<T: Debug + Hash + Eq>(values: &Vec<T>) { ... }
```

Some types implement `Debug`, some implement `Hash`, some support `Eq`; and a few, like `u32` and `String`, implement all three, as shown in [Figure 11-2](#).

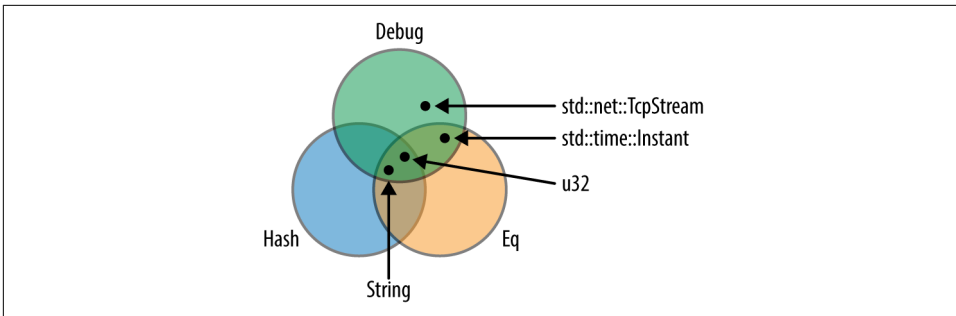

Figure 11-2. Traits as sets of types

It’s also possible for a type parameter to have no bounds at all, but you can’t do much with a value if you haven’t specified any bounds for it. You can move it. You can put it into a box or vector. That’s about it.

Generic functions can have multiple type parameters:

```
/// Run a query on a large, partitioned data set.
/// See <http://research.google.com/archive/mapreduce.html>.
fn run_query<M: Mapper + Serialize, R: Reducer + Serialize>(
    data: &DataSet, map: M, reduce: R) -> Results
{ ... }
```

As this example shows, the bounds can get to be so long that they are hard on the eyes. Rust provides an alternative syntax using the keyword `where`:

```
fn run_query<M, R>(data: &DataSet, map: M, reduce: R) -> Results
    where M: Mapper + Serialize,
          R: Reducer + Serialize
{ ... }
```

The type parameters `M` and `R` are still declared up front, but the bounds are moved to separate lines. This kind of `where` clause is also allowed on generic structs, enums, type aliases, and methods—anywhere bounds are permitted.

Of course, an alternative to `where` clauses is to keep it simple: find a way to write the program without using generics quite so intensively.

“Receiving References as Parameters” on page 105 introduced the syntax for lifetime parameters. A generic function can have both lifetime parameters and type parameters. Lifetime parameters come first.

```
/// Return a reference to the point in `candidates` that's
/// closest to the `target` point.
fn nearest<'t, 'c, P>(target: &'t P, candidates: &'c [P]) -> &'c P
    where P: MeasureDistance
{
    ...
}
```



This function takes two arguments, `target` and `candidates`. Both are references, and we give them distinct lifetimes `'t` and `'c` (as discussed in “[Distinct Lifetime Parameters](#)” on page 111). Furthermore, the function works with any type `P` that implements the `MeasureDistance` trait, so we might use it on `Point2d` values in one program and `Point3d` values in another.

Lifetimes never have any impact on machine code. Two calls to `nearest()` using the same type `P`, but different lifetimes, will call the same compiled function. Only differing types cause Rust to compile multiple copies of a generic function.

Of course, functions are not the only kind of generic code in Rust.

- We’ve already covered generic types in “[Generic Structs](#)” on page 202 and “[Generic Enums](#)” on page 218.
- An individual method can be generic, even if the type it’s defined on is not generic:

```
impl PancakeStack {
    fn push<T: Topping>(&mut self, goop: T) -> PancakeResult<> {
        ...
    }
}
```

- Type aliases can be generic, too:

```
type PancakeResult<T> = Result<T, PancakeError>;
```

- We’ll cover generic traits later in this chapter.

All the features introduced in this section—bounds, `where` clauses, lifetime parameters, and so forth—can be used on all generic items, not just functions.

## Which to Use

The choice of whether to use trait objects or generic code is subtle. Since both features are based on traits, they have a lot in common.

Trait objects are the right choice whenever you need a collection of values of mixed types, all together. It is technically possible to make generic salad:

```
trait Vegetable {
    ...
}

struct Salad<V: Vegetable> {
    veggies: Vec<V>
}
```

but this is a rather severe design. Each such salad consists entirely of a single type of vegetable. Not everyone is cut out for this sort of thing. One of your authors once

paid \$14 for a `Salad<IcebergLettuce>` and has never quite gotten over the experience.

How can we build a better salad? Since `Vegetable` values can be all different sizes, we can't ask Rust for a `Vec<Vegetable>`:

```
struct Salad {
    veggies: Vec<Vegetable> // error: `Vegetable` does not have
                           // a constant size
}
```

Trait objects are the solution:

```
struct Salad {
    veggies: Vec<Box<Vegetable>>
}
```

Each `Box<Vegetable>` can own any type of vegetable, but the box itself has a constant size—two pointers—suitable for storing in a vector. Apart from the unfortunate mixed metaphor of having boxes in one's food, this is precisely what's called for, and it would work out just as well for shapes in a drawing app, monsters in a game, pluggable routing algorithms in a network router, and so on.

Another possible reason to use trait objects is to reduce the total amount of compiled code. Rust may have to compile a generic function many times, once for each type it's used with. This could make the binary large, a phenomenon called *code bloat* in C++ circles. These days, memory is plentiful, and most of us have the luxury of ignoring code size; but constrained environments do exist.

Outside of situations involving salad or microcontrollers, generics have two important advantages over trait objects, with the result that in Rust, generics are the more common choice.

The first advantage is speed. Each time the Rust compiler generates machine code for a generic function, it knows which types it's working with, so it knows at that time which `write` method to call. There's no need for dynamic dispatch.

The generic `min()` function shown in the introduction is just as fast as if we had written separate functions `min_u8`, `min_i64`, `min_string`, and so on. The compiler can inline it, like any other function, so in a release build, a call to `min::<i32>` is likely just two or three instructions. A call with constant arguments, like `min(5, 3)`, will be even faster: Rust can evaluate it at compile time, so that there's no runtime cost at all.

Or consider this generic function call:

```
let mut sink = std::io::sink();
say_hello(&mut sink)?;
```

`std::io::sink()` returns a writer of type `Sink` that quietly discards all bytes written to it.

When Rust generates machine code for this, it could emit code that calls `Sink::write_all`, checks for errors, then calls `Sink::flush`. That's what the body of the generic function says to do.

Or, Rust could look at those methods and realize the following:

- `Sink::write_all()` does nothing.
- `Sink::flush()` does nothing.
- Neither method ever returns an error.

In short, Rust has all the information it needs to optimize away this function entirely.

Compare that to the behavior with trait objects. Rust never knows what type of value a trait object points to until run time. So even if you pass a `Sink`, the overhead of calling virtual methods and checking for errors still applies.

The second advantage of generics is that not every trait can support trait objects. Traits support several features, such as static methods, that work only with generics: they rule out trait objects entirely. We'll point out these features as we come to them.

## Defining and Implementing Traits

Defining a trait is simple. Give it a name and list the type signatures of the trait methods. If we're writing a game, we might have a trait like this:

```
/// A trait for characters, items, and scenery -  
/// anything in the game world that's visible on screen.  
trait Visible {  
    /// Render this object on the given canvas.  
    fn draw(&self, canvas: &mut Canvas);  
  
    /// Return true if clicking at (x, y) should  
/// select this object.  
    fn hit_test(&self, x: i32, y: i32) -> bool;  
}
```

To implement a trait, use the syntax `impl TraitName for Type`:

```
impl Visible for Broom {  
    fn draw(&self, canvas: &mut Canvas) {  
        for y in self.y - self.height - 1 .. self.y {  
            canvas.write_at(self.x, y, '|');  
        }  
        canvas.write_at(self.x, self.y, 'M');  
    }  
  
    fn hit_test(&self, x: i32, y: i32) -> bool {  
        self.x == x  
        && self.y - self.height - 1 <= y  
    }  
}
```

```

        && y <= self.y
    }
}

```

Note that this `impl` contains an implementation for each method of the `Visible` trait, and nothing else. Everything defined in a trait `impl` must actually be a feature of the trait; if we wanted to add a helper method in support of `Broom::draw()`, we would have to define it in a separate `impl` block:

```

impl Broom {
    /// Helper function used by Broom::draw() below.
    fn broomstick_range(&self) -> Range<i32> {
        self.y - self.height - 1 .. self.y
    }
}

impl Visible for Broom {
    fn draw(&self, canvas: &mut Canvas) {
        for y in self.broomstick_range() {
            ...
        }
        ...
    }
    ...
}

```

## Default Methods

The `Sink` writer type we discussed earlier can be implemented in a few lines of code. First, we define the type:

```

/// A Writer that ignores whatever data you write to it.
pub struct Sink;

```

`Sink` is an empty struct, since we don't need to store any data in it. Next, we provide an implementation of the `Write` trait for `Sink`:

```

use std::io::{Write, Result};

impl Write for Sink {
    fn write(&mut self, buf: &[u8]) -> Result<usize> {
        // Claim to have successfully written the whole buffer.
        Ok(buf.len())
    }

    fn flush(&mut self) -> Result<()> {
        Ok(())
    }
}

```

So far, this is very much like the `Visible` trait. But we have also seen that the `Write` trait has a `write_all` method:

```
out.write_all(b"hello world\n"?);
```

Why does Rust let us impl Write for Sink without defining this method? The answer is that the standard library's definition of the Write trait contains a *default implementation* for write\_all:

```
trait Write {
    fn write(&mut self, buf: &[u8]) -> Result<usize>;
    fn flush(&mut self) -> Result<()>;

    fn write_all(&mut self, buf: &[u8]) -> Result<()> {
        let mut bytes_written = 0;
        while bytes_written < buf.len() {
            bytes_written += self.write(&buf[bytes_written..])?;
        }
        Ok(())
    }
    ...
}
```

The write and flush methods are the basic methods that every writer must implement. A writer may also implement write\_all, but if not, the default implementation shown above will be used.

Your own traits can include default implementations using the same syntax.

The most dramatic use of default methods in the standard library is the Iterator trait, which has one required method (.next()) and dozens of default methods. [Chapter 15](#) explains why.

## Traits and Other People's Types

Rust lets you implement any trait on any type, as long as either the trait or the type is introduced in the current crate.

This means that any time you want to add a method to any type, you can use a trait to do it:

```
trait IsEmoji {
    fn is_emoji(&self) -> bool;
}

/// Implement IsEmoji for the built-in character type.
impl IsEmoji for char {
    fn is_emoji(&self) -> bool {
        ...
    }
}

assert_eq!('$'.is_emoji(), false);
```

Like any other trait method, this new `is_emoji` method is only visible when `IsEmoji` is in scope.

The sole purpose of this particular trait is to add a method to an existing type, `char`. This is called an *extension trait*. Of course, you can add this trait to types, too, by writing `impl IsEmoji for str { ... }` and so forth.

You can even use a generic `impl` block to add an extension trait to a whole family of types at once. The following extension trait adds a method to all Rust writers:

```
use std::io::{self, Write};

// Trait for values to which you can send HTML.
trait WriteHtml {
    fn write_html(&mut self, &HtmlDocument) -> io::Result<()>;
}

// You can write HTML to any std::io writer.
impl<W: Write> WriteHtml for W {
    fn write_html(&mut self, html: &HtmlDocument) -> io::Result<()> {
        ...
    }
}
```

The line `impl<W: Write> WriteHtml for W` means “for every type `W` that implements `Write`, here’s an implementation of `WriteHtml` for `W`.”

The `serde` library offers a nice example of how useful it can be to implement user-defined traits on standard types. `serde` is a serialization library. That is, you can use it to write Rust data structures to disk and reload them later. The library defines a trait, `Serialize`, that’s implemented for every data type the library supports. So in the `serde` source code, there is code implementing `Serialize` for `bool`, `i8`, `i16`, `i32`, array and tuple types, and so on, through all the standard data structures like `Vec` and `HashMap`.

The upshot of all this is that `serde` adds a `.serialize()` method to all these types. It can be used like this:

```
use serde::Serialize;
use serde_json;

pub fn save_configuration(config: &HashMap<String, String>)
    -> std::io::Result<()>
{
    // Create a JSON serializer to write the data to a file.
    let writer = File::create(config_filename())?;
    let mut serializer = serde_json::Serializer::new(writer);

    // The serde `.serialize()` method does the rest.
    config.serialize(&mut serializer)?;
}
```

```
    Ok(())
}
```

We said earlier that when you implement a trait, either the trait or the type must be new in the current crate. This is called the *coherence rule*. It helps Rust ensure that trait implementations are unique. Your code can't `impl Write` for `u8`, because both `Write` and `u8` are defined in the standard library. If Rust let crates do that, there could be multiple implementations of `Write` for `u8`, in different crates, and Rust would have no reasonable way to decide which implementation to use for a given method call.

(C++ has a similar uniqueness restriction: the One Definition Rule. In typical C++ fashion, it isn't enforced by the compiler, except in the simplest cases, and you get undefined behavior if you break it.)

## Self in Traits

A trait can use the keyword `Self` as a type. The standard `Clone` trait, for example, looks like this (slightly simplified):

```
pub trait Clone {
    fn clone(&self) -> Self;
    ...
}
```

Using `Self` as the return type here means that the type of `x.clone()` is the same as the type of `x`, whatever that might be. If `x` is a `String`, then the type of `x.clone()` is `String`—not `Clone` or any other cloneable type.

Likewise, if we define this trait:

```
pub trait Spliceable {
    fn splice(&self, other: &Self) -> Self;
}
```

with two implementations:

```
impl Spliceable for CherryTree {
    fn splice(&self, other: &Self) -> Self {
        ...
    }
}

impl Spliceable for Mammoth {
    fn splice(&self, other: &Self) -> Self {
        ...
    }
}
```

then inside the first `impl`, `Self` is simply an alias for `CherryTree`, and in the second, it's an alias for `Mammoth`. This means that we can splice together two cherry trees or

two mammoths, not that we can create a mammoth-cherry hybrid. The type of `self` and the type of `other` must match.

A trait that uses the `Self` type is incompatible with trait objects:

```
// error: the trait `Spliceable` cannot be made into an object
fn splice_anything(left: &Spliceable, right: &Spliceable) {
    let combo = left.splice(right);
    ...
}
```

The reason is something we'll see again and again as we dig into the advanced features of traits. Rust rejects this code because it has no way to type-check the call `left.splice(right)`. The whole point of trait objects is that the type isn't known until runtime. Rust has no way to know at compile time if `left` and `right` will be the same type, as required.

Trait objects are really intended for the simplest kinds of traits, the kinds that could be implemented using interfaces in Java or abstract base classes in C++. The more advanced features of traits are useful, but they can't coexist with trait objects because with trait objects, you lose the type information Rust needs to type-check your program.

Now, had we wanted genetically improbable splicing, we could have designed a trait-object-friendly trait:

```
pub trait MegaSpliceable {
    fn splice(&self, other: &MegaSpliceable) -> Box<MegaSpliceable>;
}
```

This trait is compatible with trait objects. There's no problem type-checking calls to this `.splice()` method because the type of the argument `other` is not required to match the type of `self`, as long as both types are `MegaSpliceable`.

## Subtraits

We can declare that a trait is an extension of another trait:

```
/// Someone in the game world, either the player or some other
/// pixie, gargoyle, squirrel, ogre, etc.
trait Creature: Visible {
    fn position(&self) -> (i32, i32);
    fn facing(&self) -> Direction;
    ...
}
```

The phrase `trait Creature: Visible` means that all creatures are visible. Every type that implements `Creature` must also implement the `Visible` trait:

```
impl Visible for Broom {
    ...
}
```



```

}

impl Creature for Broom {
    ...
}

```

We can implement the two traits in either order, but it's an error to implement `Creature` for a type without also implementing `Visible`.

Subtraits are like subinterfaces in Java or C#. They're a way to describe a trait that extends an existing trait with a few more methods. In this example, all your code that works with `Creatures` can also use the methods from the `Visible` trait.

## Static Methods

In most object-oriented languages, interfaces can't include static methods or constructors. However, Rust traits can include static methods and constructors, here is how:

```

trait StringSet {
    /// Return a new empty set.
    fn new() -> Self;

    /// Return a set that contains all the strings in `strings`.
    fn from_slice(strings: &[&str]) -> Self;

    /// Find out if this set contains a particular `value`.
    fn contains(&self, string: &str) -> bool;

    /// Add a string to this set.
    fn add(&mut self, string: &str);
}

```

Every type that implements the `StringSet` trait must implement these four associated functions. The first two, `new()` and `from_slice()`, don't take a `self` argument. They serve as constructors.

In nongeneric code, these functions can be called using `::` syntax, just like any other static method:

```

// Create sets of two hypothetical types that impl StringSet:
let set1 = SortedStringSet::new();
let set2 = HashedStringSet::new();

```

In generic code, it's the same, except the type is often a type variable, as in the call to `S::new()` shown here:

```

/// Return the set of words in `document` that aren't in `wordlist`.
fn unknown_words<S: StringSet>(document: &Vec<String>, wordlist: &S) -> S {
    let mut unknowns = S::new();
    for word in document {
        if !wordlist.contains(word) {

```

```

        unknowns.add(word);
    }
}
unknowns
}

```

Like Java and C# interfaces, trait objects don't support static methods. If you want to use `&StringSet` trait objects, you must change the trait, adding the bound where `Self: Sized` to each static method:

```

trait StringSet {
    fn new() -> Self
        where Self: Sized;

    fn from_slice(strings: &[&str]) -> Self
        where Self: Sized;

    fn contains(&self, string: &str) -> bool;

    fn add(&mut self, string: &str);
}

```

This bound tells Rust that trait objects are excused from supporting this method. `StringSet` trait objects are then allowed; they still don't support the two static methods, but you can create them and use them to call `.contains()` and `.add()`. The same trick works for any other method that is incompatible with trait objects. (We will forgo the rather tedious technical explanation of why this works, but the `Sized` trait is covered in [Chapter 13](#).)

## Fully Qualified Method Calls

A method is just a special kind of function. These two calls are equivalent:

```

"hello".to_string()

str::to_string("hello")

```

The second form looks exactly like a static method call. This works even though the `to_string` method takes a `self` argument. Simply pass `self` as the function's first argument.

Since `to_string` is a method of the standard `ToString` trait, there are two more forms you can use:

```

ToString::to_string("hello")

<str as ToString>::to_string("hello")

```

All four of these method calls do exactly the same thing. Most often, you'll just write `value.method()`. The other forms are *qualified* method calls. They specify the type or

trait that a method is associated with. The last form, with the angle brackets, specifies both: a *fully qualified* method call.

When you write `"hello".to_string()`, using the `.` operator, you don't say exactly which `to_string` method you're calling. Rust has a method lookup algorithm that figures this out, depending on the types, deref coercions, and so on. With fully qualified calls, you can say exactly which method you mean, and that can help in a few odd cases:

- When two methods have the same name. The classic hokey example is the `Outlaw` with two `.draw()` methods from two different traits, one for drawing it on the screen and one for interacting with the law:

```
outlaw.draw(); // error: draw on screen or draw pistol?

Visible::draw(&outlaw); // ok: draw on screen
HasPistol::draw(&outlaw); // ok: corral
```

Normally you're better off just renaming one of the methods, but sometimes you can't.

- When the type of the `self` argument can't be inferred:

```
let zero = 0; // type unspecified; could be `i8`, `u8`, ...

zero.abs(); // error: method `abs` not found
i64::abs(zero); // ok
```

- When using the function itself as a function value:

```
let words: Vec<String> =
    line.split_whitespace() // iterator produces &str values
        .map(<str as ToString>::to_string) // ok
        .collect();
```

Here the fully qualified `<str as ToString>::to_string` is just a way to name the specific function we want to pass to `.map()`.

- When calling trait methods in macros. We'll explain in [Chapter 20](#).

Fully qualified syntax also works for static methods. In the previous section, we wrote `S::new()` to create a new set in a generic function. We could also have written `StringSet::new()` or `<S as StringSet>::new()`.

## Traits That Define Relationships Between Types

So far, every trait we've looked at stands alone: a trait is a set of methods that types can implement. Traits can also be used in situations where there are multiple types that have to work together. They can describe relationships between types.

- The `std::iter::Iterator` trait relates each iterator type with the type of value it produces.
- The `std::ops::Mul` trait relates types that can be multiplied. In the expression `a * b`, the values `a` and `b` can be either the same type, or different types.
- The `rand` crate includes both a trait for random number generators (`rand::Rng`) and a trait for types that can be randomly generated (`rand::Rand`). The traits themselves define exactly how these types work together.

You won't need to create traits like these every day, but you'll come across them throughout the standard library and in third-party crates. In this section, we'll show how each of these examples is implemented, picking up relevant Rust language features as we need them. The key skill here is the ability to read traits and method signatures and figure out what they say about the types involved.

## Associated Types (or How Iterators Work)

We'll start with iterators. By now every object-oriented language has some sort of built-in support for iterators, objects that represent the traversal of some sequence of values.

Rust has a standard `Iterator` trait, defined like this:

```
pub trait Iterator {
    type Item;

    fn next(&mut self) -> Option<Self::Item>;
    ...
}
```

The first feature of this trait, `type Item`;, is an *associated type*. Each type that implements `Iterator` must specify what type of item it produces.

The second feature, the `next()` method, uses the associated type in its return value. `next()` returns an `Option<Self::Item>`: either `Some(item)`, the next value in the sequence, or `None` when there are no more values to visit. The type is written as `Self::Item`, not just plain `Item`, because `Item` is a feature of each type of iterator, not a standalone type. As always, `self` and the `Self` type show up explicitly in the code everywhere their fields, methods, and so on are used.

Here's what it looks like to implement `Iterator` for a type:

```
// (code from the std::env standard library module)
impl Iterator for Args {
    type Item = String;

    fn next(&mut self) -> Option<String> {
        ...
    }
}
```

```

    }
    ...
}

```

`std::env::Args` is the type of iterator returned by the standard library function `std::env::args()` that we used in [Chapter 2](#) to access command-line arguments. It produces `String` values, so the `impl` declares type `Item = String`.

Generic code can use associated types:

```

/// Loop over an iterator, storing the values in a new vector.
fn collect_into_vector<I: Iterator>(iter: I) -> Vec<I::Item> {
    let mut results = Vec::new();
    for value in iter {
        results.push(value);
    }
    results
}

```

Inside the body of this function, Rust infers the type of `value` for us, which is nice; but we must spell out the return type of `collect_into_vector`, and the `Item` associated type is the only way to do that. (`Vec<I>` would be simply wrong: we would be claiming to return a vector of iterators!)

The preceding example is not code that you would write out yourself, because after reading [Chapter 15](#), you'll know that iterators already have a standard method that does this: `iter.collect()`. So let's look at one more example before moving on.

```

/// Print out all the values produced by an iterator
fn dump<I>(iter: I)
    where I: Iterator
{
    for (index, value) in iter.enumerate() {
        println!("{}: {:?}", index, value); // error
    }
}

```

This almost works. There is just one problem: `value` might not be a printable type.

```

error[E0277]: the trait bound `::Item:
    std::fmt::Debug` is not satisfied
--> traits_dump.rs:10:37
|
10 | println!("{}: {:?}", index, value); // error
|                                     ^^^^^ the trait `std::fmt::Debug`
|                                     is not implemented for
|                                     `::Item`
|
= help: consider adding a
       `where <I as std::iter::Iterator>::Item: std::fmt::Debug` bound
= note: required by `std::fmt::Debug::fmt`

```

The error message is slightly obfuscated by Rust’s use of the syntax `<I as std::iter::Iterator>::Item`, which is a long, maximally explicit way of saying `I::Item`. This is valid Rust syntax, but you’ll rarely actually need to write a type out that way.

The gist of the error message is that to make this generic function compile, we must ensure that `I::Item` implements the `Debug` trait, the trait for formatting values with `{:?}`. We can do this by placing a bound on `I::Item`:

```
use std::fmt::Debug;

fn dump<I>(iter: I)
    where I: Iterator, I::Item: Debug
{
    ...
}
```

Or, we could write, “I must be an iterator over `String` values”:

```
fn dump<I>(iter: I)
    where I: Iterator<Item=String>
{
    ...
}
```

`Iterator<Item=String>` is itself a trait. If you think of `Iterator` as the set of all iterator types, then `Iterator<Item=String>` is a subset of `Iterator`: the set of iterator types that produce `Strings`. This syntax can be used anywhere the name of a trait can be used, including trait object types:

```
fn dump(iter: &mut Iterator<Item=String>) {
    for (index, s) in iter.enumerate() {
        println!("{}: {:?}", index, s);
    }
}
```

Traits with associated types, like `Iterator`, are compatible with trait methods, but only if all the associated types are spelled out, as shown here. Otherwise, the type of `s` could be anything, and again, Rust would have no way to type-check this code.

We’ve shown a lot of examples involving iterators. It’s hard not to; they’re by far the most prominent use of associated types. But associated types are generally useful whenever a trait needs to cover more than just methods.

- In a thread pool library, a `Task` trait, representing a unit of work, could have an associated `Output` type.
- A `Pattern` trait, representing a way of searching a string, could have an associated `Match` type, representing all the information gathered by matching the pattern to the string.

```

trait Pattern {
    type Match;

    fn search(&self, string: &str) -> Option<Self::Match>;
}

/// You can search a string for a particular character.
impl Pattern for char {
    /// A "match" is just the location where the
    /// character was found.
    type Match = usize;

    fn search(&self, string: &str) -> Option<usize> {
        ...
    }
}

```

If you're familiar with regular expressions, it's easy to see how `impl Pattern for RegExp` would have a more elaborate `Match` type, probably a struct that would include the start and length of the match, the locations where parenthesized groups matched, and so on.

- A library for working with relational databases might have a `Database Connection` trait with associated types representing transactions, cursors, prepared statements, and so on.

Associated types are perfect for cases where each implementation has *one* specific related type: each type of `Task` produces a particular type of `Output`; each type of `Pattern` looks for a particular type of `Match`. However, as we'll see, some relationships among types are not like this.

## Generic Traits (or How Operator Overloading Works)

Multiplication in Rust uses this trait:

```

/// std::ops::Mul, the trait for types that support `*`.
pub trait Mul<RHS> {
    /// The resulting type after applying the `*` operator
    type Output;

    /// The method for the `*` operator
    fn mul(self, rhs: RHS) -> Self::Output;
}

```

`Mul` is a generic trait. The type parameter, `RHS`, is short for *right hand side*.

The type parameter here means the same thing that it means on a struct or function: `Mul` is a generic trait, and its instances `Mul<f64>`, `Mul<String>`, `Mul<Size>`, etc. are all

different traits, just as `min::<i32>` and `min::<String>` are different functions and `Vec<i32>` and `Vec<String>` are different types.

A single type—say, `WindowSize`—can implement both `Mul<f64>` and `Mul<i32>`, and many more. You would then be able to multiply a `WindowSize` by many other types. Each implementation would have its own associated `Output` type.

The trait shown above is missing one minor detail. The real `Mul` trait looks like this:

```
pub trait Mul<RHS=Self> {  
    ...  
}
```

The syntax `RHS=Self` means that `RHS` defaults to `Self`. If I write `impl Mul` for `Complex`, without specifying `Mul`'s type parameter, it means `impl Mul<Complex>` for `Complex`. In a bound, if I write `where T: Mul`, it means `where T: Mul<T>`.

In Rust, the expression `lhs * rhs` is shorthand for `Mul::mul(lhs, rhs)`. So overloading the `*` operator in Rust is as simple as implementing the `Mul` trait. We'll show examples in the next chapter.

## Buddy Traits (or How `rand::random()` Works)

There's one more way to use traits to express relationships between types. This way is perhaps the simplest of the bunch, since you don't have to learn any new language features to understand it: what we'll call *buddy traits* are simply traits that are designed to work together.

There's a good example inside the `rand` crate, a popular crate for generating random numbers. The main feature of `rand` is the `random()` function, which returns a random value:

```
use rand::random;  
let x = random();
```

If Rust can't infer the type of the random value, which is often the case, you must specify it:

```
let x = random::<f64>(); // a number, 0.0 <= x < 1.0  
let b = random::<bool>(); // true or false
```

For many programs, this one generic function is all you need. But the `rand` crate also offers several different, but interoperable, random number generators. All the random number generators in the library implement a common trait:

```
/// A random number generator.  
pub trait Rng {  
    fn next_u32(&mut self) -> u32;  
    ...  
}
```



An `Rng` is simply a value that can spit out integers on demand. The `rand` library provides a few different implementations, including `XorShiftRng` (a fast pseudorandom number generator) and `OsRng` (much slower, but truly unpredictable, for use in cryptography).

The buddy trait is called `Rand`:

```
/// A type that can be randomly generated using an `Rng`.
pub trait Rand: Sized {
    fn rand<R: Rng>(rng: &mut R) -> Self;
}
```

Types like `f64` and `bool` implement this trait. Pass any random number generator to their `::rand()` method, and it returns a random value:

```
let x = f64::rand(rng);
let b = bool::rand(rng);
```

In fact `random()` is nothing but a thin wrapper that passes a globally allocated `Rng` to this `rand` method. One way to implement it is like this:

```
pub fn random<T: Rand>() -> T {
    T::rand(&mut global_rng())
}
```

When you see traits that use other traits as bounds, the way `Rand::rand()` uses `Rng`, you know that those two traits are mix-and-match: any `Rng` can generate values of every `Rand` type. Since the methods involved are generic, Rust generates optimized machine code for each combination of `Rng` and `Rand` that your program actually uses.

The two traits also serve to separate concerns. Whether you're implementing `Rand` for your `Monster` type or implementing a spectacularly fast but not-so-random `Rng`, you don't have to do anything special for those two pieces of code to be able to work together, as shown in [Figure 11-3](#).

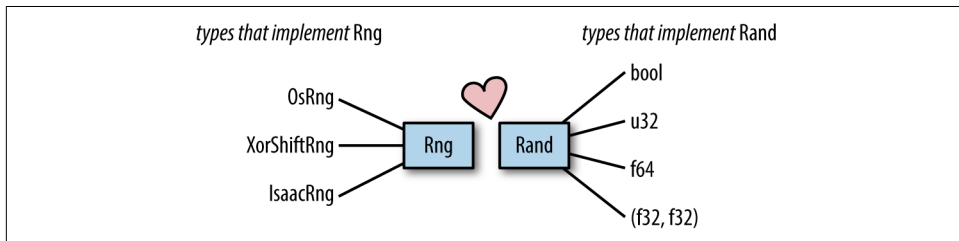

*Figure 11-3. Buddy traits illustrated. The `Rng` types listed on the left are real random number generators provided by the `rand` crate.*

The standard library's support for computing hash codes provides another example of buddy traits. Types that implement `Hash` are hashable, so they can be used as hash table keys. Types that implement `Hasher` are hashing algorithms. The two are linked

in the same way as `Rand` and `Rng`: `Hash` has a generic method `Hash::hash()` that accepts any type of `Hasher` as an argument.

Another example is the `serde` library's `Serialize` trait, which you saw in “[Traits and Other People's Types](#)” on page 247. It has a buddy trait we didn't talk about: the `Serializer` trait, which represents the output format. `serde` supports pluggable serialization formats. There are `Serializer` implementations for JSON, YAML, a binary format called CBOR, and so on. Thanks to the close relationship between the two traits, every format automatically supports every serializable type.

In the last three sections, we've shown three ways traits can describe relationships between types. All of these can also be seen as ways of avoiding virtual method overhead and downcasts, since they allow Rust to know more concrete types at compile time.

## Reverse-Engineering Bounds

Writing generic code can be a real slog when there's no single trait that does everything you need. Suppose we have written this nongeneric function to do some computation:

```
fn dot(v1: &[i64], v2: &[i64]) -> i64 {
    let mut total = 0;
    for i in 0 .. v1.len() {
        total = total + v1[i] * v2[i];
    }
    total
}
```

Now we want to use the same code with floating-point values. We might try something like this:

```
fn dot<N>(v1: &[N], v2: &[N]) -> N {
    let mut total: N = 0;
    for i in 0 .. v1.len() {
        total = total + v1[i] * v2[i];
    }
    total
}
```

No such luck: Rust complains about the use of `+` and `*` and the type of `0`. We can require `N` to be a type that supports `+` and `*` using the `Add` and `Mul` traits. Our use of `0` needs to change, though, because `0` is always an integer in Rust; the corresponding floating-point value is `0.0`. Fortunately, there is a standard `Default` trait for types that have default values. For numeric types, the default is always `0`.

```
use std::ops::{Add, Mul};

fn dot<N: Add + Mul + Default>(v1: &[N], v2: &[N]) -> N {
```

```

    let mut total = N::default();
    for i in 0 .. v1.len() {
        total = total + v1[i] * v2[i];
    }
    total
}

```

This is closer, but still does not quite work:

```

error[E0308]: mismatched types
--> traits_generic_dot_2.rs:11:25
   |
11 | total = total + v1[i] * v2[i];
   |                   ^^^^^^^^^^^^^^^ expected type parameter, found associated type
   |
   = note: expected type `N`
           found type `::Output`

```

Our new code assumes that that multiplying two values of type `N` produces another value of type `N`. This isn't necessarily the case. You can overload the multiplication operator to return whatever type you want. We need to somehow tell Rust that this generic function only works with types that have the normal flavor of multiplication, where multiplying `N * N` returns an `N`. We do this by replacing `Mul` with `Mul<Output=N>`, and the same for `Add`:

```

fn dot<N: Add<Output=N> + Mul<Output=N> + Default>(v1: &[N], v2: &[N]) -> N
{
    ...
}

```

At this point, the bounds are starting to pile up, making the code hard to read. Let's move the bounds into a `where` clause:

```

fn dot<N>(v1: &[N], v2: &[N]) -> N
    where N: Add<Output=N> + Mul<Output=N> + Default
{
    ...
}

```

Great. But Rust still complains about this line of code:

```

error[E0508]: cannot move out of type `[N]`, a non-copy array
--> traits_generic_dot_3.rs:7:25
   |
 7 |         total = total + v1[i] * v2[i];
   |                             ^^^^^ cannot move out of here

```

This one might be a real puzzle, even though by now we're familiar with the terminology. Yes, it would be illegal to move the value `v1[i]` out of the slice. But numbers are copyable. So what's the problem?

The answer is that *Rust doesn't know* `v1[i]` is a number. In fact, it isn't—the type `N` can be any type that satisfies the bounds we've given it. If we also want `N` to be a copyable type, we must say so:

```
where N: Add<Output=N> + Mul<Output=N> + Default + Copy
```

With this, the code compiles and runs. The final code looks like this:

```
use std::ops::{Add, Mul};

fn dot<N>(v1: &[N], v2: &[N]) -> N
  where N: Add<Output=N> + Mul<Output=N> + Default + Copy
{
    let mut total = N::default();
    for i in 0 .. v1.len() {
        total = total + v1[i] * v2[i];
    }
    total
}

#[test]
fn test_dot() {
    assert_eq!(dot(&[1, 2, 3, 4], &[1, 1, 1, 1]), 10);
    assert_eq!(dot(&[53.0, 7.0], &[1.0, 5.0]), 88.0);
}
```

This occasionally happens in Rust: there is a period of intense arguing with the compiler, at the end of which the code looks rather nice, as if it had been a breeze to write, and runs beautifully.

What we've been doing here is reverse-engineering the bounds on `N`, using the compiler to guide and check our work. The reason it was a bit of a pain is that there wasn't a single `Number` trait in the standard library that included all the operators and methods we wanted to use. As it happens, there's a popular open source crate called `num` that defines such a trait! Had we known, we could have added `num` to our *Cargo.toml* and written:

```
use num::Num;

fn dot<N: Num + Copy>(v1: &[N], v2: &[N]) -> N {
    let mut total = N::zero();
    for i in 0 .. v1.len() {
        total = total + v1[i] * v2[i];
    }
    total
}
```

Just as in object-oriented programming, the right interface makes everything nice, in generic programming, the right trait makes everything nice.

Still, why go to all this trouble? Why didn't Rust's designers make the generics more like C++ templates, where the constraints are left implicit in the code, à la "duck typing?"

One advantage of Rust's approach is forward compatibility of generic code. You can change the implementation of a public generic function or method, and if you didn't change the signature, you haven't broken any of its users.

Another advantage of bounds is that when you do get a compiler error, at least the compiler can tell you where the trouble is. C++ compiler error messages involving templates can be much longer than Rust's, pointing at many different lines of code, because the compiler has no way to tell who's to blame for a problem: the template—or its caller, which might also be a template—or *that* template's caller..

Perhaps the most important advantage of writing out the bounds explicitly is simply that they are there, in the code and in the documentation. You can look at the signature of a generic function in Rust and see exactly what kind of arguments it accepts. The same can't be said for templates. The work that goes into fully documenting argument types in C++ libraries like Boost is even *more* arduous than what we went through here. The Boost developers don't have a compiler that checks their work.

## Conclusion

Traits are one of the main organizing features in Rust, and with good reason. There's nothing better to design a program or library around than a good interface.

This chapter was a blizzard of syntax, rules, and explanations. Now that we've laid a foundation, we can start talking about the many ways traits and generics are used in Rust code. The fact is, we've only begun to scratch the surface. The next two chapters cover common traits provided by the standard library. Upcoming chapters cover closures, iterators, input/output, and concurrency. Traits and generics play a central role in all of these topics.



---

# Operator Overloading

*There is a range of views among mathematicians and philosophers as to the exact scope and definition of mathematics. ...All have severe problems, none has widespread acceptance, and no reconciliation seems possible.*

— Wikipedia, “[Mathematics](#)”

In the Mandelbrot set plotter we showed in [Chapter 2](#), we used the `num crate`’s `Complex` type to represent a number on the complex plane:

```
#[derive(Clone, Copy, Debug)]
struct Complex<T> {
    /// Real portion of the complex number
    re: T,

    /// Imaginary portion of the complex number
    im: T
}
```

We were able to add and multiply `Complex` numbers just like any built-in numeric type, using Rust’s `+` and `*` operators:

```
z = z * z + c;
```

You can make your own types support arithmetic and other operators, too, just by implementing a few built-in traits. This is called *operator overloading*, and the effect is much like operator overloading in C++, C#, Python, and Ruby.

The traits for operator overloading fall into a few categories depending on what part of the language they support, as shown in [Table 12-1](#). The remaining sections of this chapter cover each category in turn.

Table 12-1. Summary of traits for operator overloading

Category	Trait	Operator
Unary operators	<code>std::ops::Neg</code>	<code>-x</code>
	<code>std::ops::Not</code>	<code>!x</code>
Arithmetic operators	<code>std::ops::Add</code>	<code>x + y</code>
	<code>std::ops::Sub</code>	<code>x - y</code>
	<code>std::ops::Mul</code>	<code>x * y</code>
	<code>std::ops::Div</code>	<code>x / y</code>
	<code>std::ops::Rem</code>	<code>x % y</code>
Bitwise operators	<code>std::ops::BitAnd</code>	<code>x &amp; y</code>
	<code>std::ops::BitOr</code>	<code>x   y</code>
	<code>std::ops::BitXor</code>	<code>x ^ y</code>
	<code>std::ops::Shl</code>	<code>x &lt;&lt; y</code>
	<code>std::ops::Shr</code>	<code>x &gt;&gt; y</code>
Compound assignment arithmetic operators	<code>std::ops::AddAssign</code>	<code>x += y</code>
	<code>std::ops::SubAssign</code>	<code>x -= y</code>
	<code>std::ops::MulAssign</code>	<code>x *= y</code>
	<code>std::ops::DivAssign</code>	<code>x /= y</code>
Compound assignment bitwise operators	<code>std::ops::RemAssign</code>	<code>x %= y</code>
	<code>std::ops::BitAndAssign</code>	<code>x &amp;= y</code>
	<code>std::ops::BitOrAssign</code>	<code>x  = y</code>
	<code>std::ops::BitXorAssign</code>	<code>x ^= y</code>
Comparison	<code>std::ops::ShlAssign</code>	<code>x &lt;&lt;= y</code>
	<code>std::ops::ShrAssign</code>	<code>x &gt;&gt;= y</code>
	<code>std::cmp::PartialEq</code>	<code>x == y, x != y</code>
	<code>std::cmp::PartialOrd</code>	<code>x &lt; y, x &lt;= y, x &gt; y, x &gt;= y</code>
Indexing	<code>std::ops::Index</code>	<code>x[y], &amp;x[y]</code>
	<code>std::ops::IndexMut</code>	<code>x[y] = z, &amp;mut x[y]</code>

## Arithmetic and Bitwise Operators

In Rust, the expression `a + b` is actually shorthand for `a.add(b)`, a call to the `add` method of the standard library's `std::ops::Add` trait. Rust's standard numeric types all implement `std::ops::Add`. To make the expression `a + b` work for `Complex` values, the `num` crate implements this trait for `Complex` as well. Similar traits cover the other operators: `a * b` is shorthand for `a.mul(b)`, a method from the `std::ops::Mul` trait, `std::ops::Neg` covers the prefix `-` negation operator, and so on.



If you want to try writing out `z.add(c)`, you'll need to bring the `Add` trait into scope, so that its method is visible. That done, you can treat all arithmetic as function calls:<sup>1</sup>

```
use std::ops::Add;

assert_eq!(4.125f32.add(5.75), 9.875);
assert_eq!(10.add(20), 10 + 20);
```

Here's the definition of `std::ops::Add`:

```
trait Add<RHS=Self> {
    type Output;
    fn add(self, rhs: RHS) -> Self::Output;
}
```

In other words, the trait `Add<T>` is the ability to add a `T` value to yourself. For example, if you want to be able to add `i32` and `u32` values to your type, your type must implement both `Add<i32>` and `Add<u32>`. The trait's type parameter `RHS` defaults to `Self`, so if you're implementing addition between two values of the same type, you can simply write `Add` for that case. The associated type `Output` describes the result of the addition.

For example, to be able to add `Complex<i32>` values together, `Complex<i32>` must implement `Add<Complex<i32>>`. Since we're adding a type to itself, we just write `Add`:

```
use std::ops::Add;

impl Add for Complex<i32> {
    type Output = Complex<i32>;
    fn add(self, rhs: Self) -> Self {
        Complex { re: self.re + rhs.re, im: self.im + rhs.im }
    }
}
```

Of course, we shouldn't have to implement `Add` separately for `Complex<i32>`, `Complex<f32>`, `Complex<f64>`, and so on. All the definitions would look exactly the same except for the types involved, so we should be able to write a single generic implementation that covers them all, as long as the type of the complex components themselves supports addition:

```
use std::ops::Add;

impl<T> Add for Complex<T>
    where T: Add<Output=T>
{
    type Output = Self;
```

---

<sup>1</sup> Lisp programmers rejoice! The expression `<i32 as Add>::add` is the `+` operator on `i32`, captured as a function value.

```

    fn add(self, rhs: Self) -> Self {
        Complex { re: self.re + rhs.re, im: self.im + rhs.im }
    }
}

```

By writing `where T: Add<Output=T>`, we restrict `T` to types that can be added to themselves, yielding another `T` value. This is a reasonable restriction, but we could loosen things still further: the `Add` trait doesn't require both operands of `+` to have the same type, nor does it constrain the result type. So a maximally generic implementation would let the left- and right-hand operands vary independently, and produce a `Complex` value of whatever component type that addition produces:

```

use std::ops::Add;

impl<L, R, O> Add<Complex<R>> for Complex<L>
    where L: Add<R, Output=O>
{
    type Output = Complex<O>;
    fn add(self, rhs: Complex<R>) -> Self::Output {
        Complex { re: self.re + rhs.re, im: self.im + rhs.im }
    }
}

```

In practice, however, Rust tends to avoid supporting mixed-type operations. Since our type parameter `L` must implement `Add<R, Output=O>`, it usually follows that `L`, `R`, and `O` are all going to be the same type: there simply aren't that many types available for `L` that implement anything else. So in the end, this maximally generic version may not be much more useful than the prior, simpler generic definition.

Rust's built-in traits for arithmetic and bitwise operators come in three groups: unary operators, binary operators, and compound assignment operators. Within each group, the traits and their methods all have the same form, so we'll cover one example from each.

## Unary Operators

Aside from the dereferencing operator `*`, which we'll cover separately in [“Deref and DerefMut” on page 289](#), Rust has two unary operators that you can customize, shown in [Table 12-2](#).

*Table 12-2. Built-in traits for unary operators*

Trait name	Expression	Equivalent expression
<code>std::ops::Neg</code>	<code>-x</code>	<code>x.neg()</code>
<code>std::ops::Not</code>	<code>!x</code>	<code>x.not()</code>

All of Rust's numeric types implement `std::ops::Neg`, for the unary negation operator `-`; the integer types and `bool` implement `std::ops::Not`, for the unary complement operator `!`. There are also implementations for references to those types.

Note that `!` complements `bool` values, and performs a bitwise complement (that is, flips the bits) when applied to integers; it plays the role of both the `!` and `~` operators from C and C++.

These traits' definitions are simple:

```
trait Neg {
    type Output;
    fn neg(self) -> Self::Output;
}

trait Not {
    type Output;
    fn not(self) -> Self::Output;
}
```

Negating a complex number simply negates each of its components. Here's how we might write a generic implementation of negation for `Complex` values:

```
use std::ops::Neg;

impl<T, O> Neg for Complex<T>
    where T: Neg<Output=O>
{
    type Output = Complex<O>;
    fn neg(self) -> Complex<O> {
        Complex { re: -self.re, im: -self.im }
    }
}
```

## Binary Operators

Rust's binary arithmetic and bitwise operators and their corresponding built-in traits appear in [Table 12-3](#).

*Table 12-3. Built-in traits for binary operators*

Category	Trait name	Expression	Equivalent expression
Arithmetic operators	<code>std::ops::Add</code>	<code>x + y</code>	<code>x.add(y)</code>
	<code>std::ops::Sub</code>	<code>x - y</code>	<code>x.sub(y)</code>
	<code>std::ops::Mul</code>	<code>x * y</code>	<code>x.mul(y)</code>
	<code>std::ops::Div</code>	<code>x / y</code>	<code>x.div(y)</code>
	<code>std::ops::Rem</code>	<code>x % y</code>	<code>x.rem(y)</code>

Category	Trait name	Expression	Equivalent expression
Bitwise operators	<code>std::ops::BitAnd</code>	<code>x &amp; y</code>	<code>x.bitand(y)</code>
	<code>std::ops::BitOr</code>	<code>x   y</code>	<code>x.bitor(y)</code>
	<code>std::ops::BitXor</code>	<code>x ^ y</code>	<code>x.bitxor(y)</code>
	<code>std::ops::Shl</code>	<code>x &lt;&lt; y</code>	<code>x.shl(y)</code>
	<code>std::ops::Shr</code>	<code>x &gt;&gt; y</code>	<code>x.shr(y)</code>

All of Rust's numeric types implement the arithmetic operators. Rust's integer types and `bool` implement the bitwise operators. There are also implementations that accept references to those types as either or both operands.

All of the traits here have the same general form. The definition of `std::ops::BitXor`, for the `^` operator, looks like this:

```
trait BitXor<RHS=Self> {
    type Output;
    fn bitxor(self, rhs: RHS) -> Self::Output;
}
```

At the beginning of this chapter, we also showed `std::ops::Add`, another trait in this category, along with several sample implementations.

The `Shl` and `Shr` traits deviate slightly from this pattern: they do not default their `RHS` type parameter to `Self`, so you must always supply the righthand operand type explicitly. The right operand of a `<<` or `>>` operator is a bit shift distance, which doesn't have much relationship to the type of the value being shifted.

You can use the `+` operator to concatenate a `String` with a `&str` slice or another `String`. However, Rust does not permit the left operand of `+` to be a `&str`, to discourage building up long strings by repeatedly concatenating small pieces on the left. (This performs poorly, requiring time quadratic in the final length of the string.) Generally, the `write!` macro is better for building up strings piece by piece; we show how to do this in [“Appending and Inserting Text” on page 399](#).

## Compound Assignment Operators

A compound assignment expression is one like `x += y` or `x &= y`: it takes two operands, performs some operation on them like addition or a bitwise AND, and stores the result back in the left operand. In Rust, the value of a compound assignment expression is always `()`, never the value stored.

Many languages have operators like these, and usually define them as shorthand for expressions like `x = x + y` or `x = x & y`. However, Rust doesn't take that approach. Instead, `x += y` is shorthand for the method call `x.add_assign(y)`, where `add_assign` is the sole method of the `std::ops::AddAssign` trait:

```

trait AddAssign<RHS=Self> {
    fn add_assign(&mut self, RHS);
}

```

Table 12-4 shows all of Rust’s compound assignment operators, and the built-in traits that implement them.

Table 12-4. Built-in traits for compound assignment operators

Category	Trait name	Expression	Equivalent expression
Arithmetic operators	<code>std::ops::AddAssign</code>	<code>x += y</code>	<code>x.add_assign(y)</code>
	<code>std::ops::SubAssign</code>	<code>x -= y</code>	<code>x.sub_assign(y)</code>
	<code>std::ops::MulAssign</code>	<code>x *= y</code>	<code>x.mul_assign(y)</code>
	<code>std::ops::DivAssign</code>	<code>x /= y</code>	<code>x.div_assign(y)</code>
	<code>std::ops::RemAssign</code>	<code>x %= y</code>	<code>x.rem_assign(y)</code>
Bitwise operators	<code>std::ops::BitAndAssign</code>	<code>x &amp;= y</code>	<code>x.bitand_assign(y)</code>
	<code>std::ops::BitOrAssign</code>	<code>x  = y</code>	<code>x.bitor_assign(y)</code>
	<code>std::ops::BitXorAssign</code>	<code>x ^= y</code>	<code>x.bitxor_assign(y)</code>
	<code>std::ops::ShlAssign</code>	<code>x &lt;&lt;= y</code>	<code>x.shl_assign(y)</code>
	<code>std::ops::ShrAssign</code>	<code>x &gt;&gt;= y</code>	<code>x.shr_assign(y)</code>

All of Rust’s numeric types implement the arithmetic compound assignment operators. Rust’s integer types and `bool` implement the bitwise compound assignment operators.

A generic implementation of `AddAssign` for our `Complex` type is straightforward:

```

use std::ops::AddAssign;

impl<T> AddAssign for Complex<T>
where T: AddAssign<T>
{
    fn add_assign(&mut self, rhs: Complex<T>) {
        self.re += rhs.re;
        self.im += rhs.im;
    }
}

```

The built-in trait for a compound assignment operator is completely independent of the built-in trait for the corresponding binary operator. Implementing `std::ops::Add` does not automatically implement `std::ops::AddAssign`; if you want Rust to permit your type as the lefthand operand of a `+=` operator, you must implement `AddAssign` yourself.

As with the binary `Shl` and `Shr` traits, the `ShlAssign` and `ShrAssign` traits deviate slightly from the pattern followed by the other compound assignment traits: they do

not default their RHS type parameter to `Self`, so you must always supply the right-hand operand type explicitly.

## Equality Tests

Rust's equality operators, `==` and `!=`, are shorthand for calls to the `std::cmp::PartialEq` trait's `eq` and `ne` methods:

```
assert_eq!(x == y, x.eq(&y));
assert_eq!(x != y, x.ne(&y));
```

Here's the definition of `std::cmp::PartialEq`:

```
trait PartialEq<Rhs: ?Sized = Self> {
    fn eq(&self, other: &Rhs) -> bool;
    fn ne(&self, other: &Rhs) -> bool { !self.eq(other) }
}
```

Since the `ne` method has a default definition, you only need to define `eq` to implement the `PartialEq` trait, so here's a complete implementation for `Complex`:

```
impl<T: PartialEq> PartialEq for Complex<T> {
    fn eq(&self, other: &Complex<T>) -> bool {
        self.re == other.re && self.im == other.im
    }
}
```

In other words, for any component type `T` that itself can be compared for equality, this implements comparison for `Complex<T>`. Assuming we've also implemented `std::ops::Mul` for `Complex` somewhere along the line, we can now write:

```
let x = Complex { re: 5, im: 2 };
let y = Complex { re: 2, im: 5 };
assert_eq!(x * y, Complex { re: 0, im: 29 });
```

Implementations of `PartialEq` are almost always of the form shown here: they compare each field of the left operand to the corresponding field of the right. These get tedious to write, and equality is a common operation to support, so if you ask, Rust will generate an implementation of `PartialEq` for you automatically. Simply add `PartialEq` to the type definition's `derive` attribute like so:

```
#[derive(Clone, Copy, Debug, PartialEq)]
struct Complex<T> {
    ...
}
```

Rust's automatically generated implementation is essentially identical to our hand-written code, comparing each field or element of the type in turn. Rust can derive `PartialEq` implementations for `enum` types as well. Naturally, each of the values the type holds (or might hold, in the case of an `enum`) must itself implement `PartialEq`.

Unlike the arithmetic and bitwise traits, which take their operands by value, `PartialEq` takes its operands by reference. This means that comparing non-Copy values like `Strings`, `Vecs`, or `HashMaps` doesn't cause them to be moved, which would be troublesome:

```
let s = "d\x6fv\x65t\x61i\x6c".to_string();
let t = "\x64o\x76e\x74a\x69l".to_string();
assert!(s == t); // s and t are only borrowed...

// ... so they still have their values here.
assert_eq!(format!("{}", s), t, "dovetail dovetail");
```

This leads us to the trait's bound on the `Rhs` type parameter, which is of a kind we haven't seen before:

```
where Rhs: ?Sized
```

This relaxes Rust's usual requirement that type parameters must be sized types, letting us write traits like `PartialEq<str>` or `PartialEq<[T]>`. The `eq` and `ne` methods take parameters of type `&Rhs`, and comparing something with a `&str` or a `&[T]` is completely reasonable. Since `str` implements `PartialEq<str>`, the following assertions are equivalent:

```
assert!("ungula" != "ungulate");
assert!("ungula".ne("ungulate"));
```

Here, both `Self` and `Rhs` would be the unsized type `str`, making `ne`'s `self` and `rhs` parameters both `&str` values. We'll discuss sized types, unsized types, and the `Sized` trait in detail in [“Sized” on page 285](#).

Why is this trait called `PartialEq`? The traditional mathematical definition of an *equivalence relation*, of which equality is one instance, imposes three requirements. For any values `x` and `y`:

- If `x == y` is true, then `y == x` must be true as well. In other words, swapping the two sides of an equality comparison doesn't affect the result.
- If `x == y` and `y == z`, then it must be the case that `x == z`. Given any chain of values, each equal to the next, each value in the chain is directly equal to every other. Equality is contagious.
- It must always be true that `x == x`.

That last requirement might seem too obvious to be worth stating, but this is exactly where things go awry. Rust's `f32` and `f64` are IEEE standard floating-point values. According to that standard, expressions like `0.0/0.0` and others with no appropriate value must produce special *not-a-number* values, usually referred to as NaN values. The standard further requires that a NaN value be treated as unequal to every other

value—including itself. For example, the standard requires all the following behaviors:

```
assert!(f64::is_nan(0.0/0.0));
assert_eq!(0.0/0.0 == 0.0/0.0, false);
assert_eq!(0.0/0.0 != 0.0/0.0, true);
```

Furthermore, any ordered comparison with a NaN value must return false:

```
assert_eq!(0.0/0.0 < 0.0/0.0, false);
assert_eq!(0.0/0.0 > 0.0/0.0, false);
assert_eq!(0.0/0.0 <= 0.0/0.0, false);
assert_eq!(0.0/0.0 >= 0.0/0.0, false);
```

So while Rust's `==` operator meets the first two requirements for equivalence relations, it clearly doesn't meet the third when used on IEEE floating-point values. This is called a *partial equivalence relation*, so Rust uses the name `PartialEq` for the `==` operator's built-in trait. If you write generic code with type parameters known only to be `PartialEq`, you may assume the first two requirements hold, but you should not assume that values always equal themselves.

That can be a bit counterintuitive, and may lead to bugs if you're not vigilant. If you'd prefer your generic code to require a full equivalence relation, you can instead use the `std::cmp::Eq` trait as a bound, which represents a full equivalence relation: if a type implements `Eq`, then `x == x` must be `true` for every value `x` of that type. In practice, almost every type that implements `PartialEq` should implement `Eq` as well; `f32` and `f64` are the only types in the standard library that are `PartialEq` but not `Eq`.

The standard library defines `Eq` as an extension of `PartialEq`, adding no new methods:

```
trait Eq: PartialEq<Self> { }
```

If your type is `PartialEq`, and you would like it to be `Eq` as well, you must explicitly implement `Eq`, even though you need not actually define any new functions or types to do so. So implementing `Eq` for our `Complex` type is quick:

```
impl<T: Eq> Eq for Complex<T> { }
```

We could implement it even more succinctly by just including `Eq` in the `derive` attribute on the `Complex` type definition:

```
#[derive(Clone, Copy, Debug, Eq, PartialEq)]
struct Complex<T> {
    ...
}
```

Derived implementations on a generic type may depend on the type parameters. With the `derive` attribute, `Complex<i32>` would implement `Eq`, because `i32` does, but `Complex<f32>` would implement only `PartialEq`, since `f32` doesn't implement `Eq`.



When you implement `std::cmp::PartialEq` yourself, Rust can't check that your definitions for the `eq` and `ne` methods actually behave as required for partial or full equivalence. They could do anything you like. Rust simply takes your word that you've implemented equality in a way that meets the expectations of the trait's users.

Although the definition of `PartialEq` provides a default definition for `ne`, you can provide your own implementation if you like. However, you must ensure that `ne` and `eq` are exact inverses of each other. Users of the `PartialEq` trait will assume this is so.

## Ordered Comparisons

Rust specifies the behavior of the ordered comparison operators `<`, `>`, `<=`, and `>=` all in terms of a single trait, `std::cmp::PartialOrd`:

```
trait PartialOrd<Rhs = Self>: PartialEq<Rhs> where Rhs: ?Sized {
    fn partial_cmp(&self, other: &Rhs) -> Option<Ordering>;

    fn lt(&self, other: &Rhs) -> bool { ... }
    fn le(&self, other: &Rhs) -> bool { ... }
    fn gt(&self, other: &Rhs) -> bool { ... }
    fn ge(&self, other: &Rhs) -> bool { ... }
}
```

Note that `PartialOrd<Rhs>` extends `PartialEq<Rhs>`: you can do ordered comparisons only on types that you can also compare for equality.

The only method of `PartialOrd` you must implement yourself is `partial_cmp`. When `partial_cmp` returns `Some(o)`, then `o` indicates `self`'s relationship to `other`:

```
enum Ordering {
    Less,        // self < other
    Equal,       // self == other
    Greater,     // self > other
}
```

But if `partial_cmp` returns `None`, that means `self` and `other` are unordered with respect to each other: neither is greater than the other, nor are they equal. Among all of Rust's primitive types, only comparisons between floating-point values ever return `None`: specifically, comparing a NaN (not-a-number) value with anything else returns `None`. We give some more background on NaN values in [“Equality Tests” on page 272](#).

Like the other binary operators, to compare values of two types `Left` and `Right`, `Left` must implement `PartialOrd<Right>`. Expressions like `x < y` or `x >= y` are shorthand for calls to `PartialOrd` methods, as shown in [Table 12-5](#).

Table 12-5. Ordered comparison operators and `PartialOrd` methods

Expression	Equivalent method call	Default definition
<code>x &lt; y</code>	<code>x.lt(y)</code>	<code>x.partial_cmp(&amp;y) == Some(Less)</code>
<code>x &gt; y</code>	<code>x.gt(y)</code>	<code>x.partial_cmp(&amp;y) == Some(Greater)</code>
<code>x &lt;= y</code>	<code>x.le(y)</code>	<pre>match x.partial_cmp(&amp;y) {   Some(Less)   Some(Equal) =&gt; true,   _ =&gt; false, }</pre>
<code>x &gt;= y</code>	<code>x.ge(y)</code>	<pre>match x.partial_cmp(&amp;y) {   Some(Greater)   Some(Equal) =&gt; true,   _ =&gt; false, }</pre>

As in prior examples, the equivalent method call code shown assumes that `std::cmp::PartialOrd` and `std::cmp::Ordering` are in scope.

If you know that values of two types are always ordered with respect to each other, then you can implement the stricter `std::cmp::Ord` trait:

```
trait Ord: Eq + PartialOrd<Self> {
  fn cmp(&self, other: &Self) -> Ordering;
}
```

The `cmp` method here simply returns an `Ordering`, instead of an `Option<Ordering>` like `partial_cmp`: `cmp` always declares its arguments equal, or indicates their relative order. Almost all types that implement `PartialOrd` should also implement `Ord`. In the standard library, `f32` and `f64` are the only exceptions to this rule.

Since there's no natural ordering on complex numbers, we can't use our `Complex` type from the previous sections to show a sample implementation of `PartialOrd`. Instead, suppose you're working with the following type, representing the set of numbers falling within a given half-open interval:

```
#[derive(Debug, PartialEq)]
struct Interval<T> {
  lower: T, // inclusive
  upper: T // exclusive
}
```

You'd like to make values of this type partially ordered: one interval is less than another if it falls entirely before the other, with no overlap. If two unequal intervals overlap, they're unordered: some element of each side is less than some element of the other. And two equal intervals are simply equal. The following implementation of `PartialOrd` implements those rules:

```

use std::cmp::{Ordering, PartialOrd};

impl<T: PartialOrd> PartialOrd<Interval<T>> for Interval<T> {
    fn partial_cmp(&self, other: &Interval<T>) -> Option<Ordering> {
        if self == other { Some(Ordering::Equal) }
        else if self.lower >= other.upper { Some(Ordering::Greater) }
        else if self.upper <= other.lower { Some(Ordering::Less) }
        else { None }
    }
}

```

With that implementation in place, you can write the following:

```

assert!(Interval { lower: 10, upper: 20 } < Interval { lower: 20, upper: 40 });
assert!(Interval { lower: 7, upper: 8 } >= Interval { lower: 0, upper: 1 });
assert!(Interval { lower: 7, upper: 8 } <= Interval { lower: 7, upper: 8 });

// Overlapping intervals aren't ordered with respect to each other.
let left = Interval { lower: 10, upper: 30 };
let right = Interval { lower: 20, upper: 40 };
assert!(!(left < right));
assert!(!(left >= right));

```

## Index and IndexMut

You can specify how an indexing expression like `a[i]` works on your type by implementing the `std::ops::Index` and `std::ops::IndexMut` traits. Arrays support the `[]` operator directly, but on any other type, the expression `a[i]` is normally shorthand for `*a.index(i)`, where `index` is a method of the `std::ops::Index` trait. However, if the expression is being assigned to or borrowed mutably, it's instead shorthand for `*a.index_mut(i)`, a call to the method of the `std::ops::IndexMut` trait.

Here are the traits' definitions:

```

trait Index<Idx> {
    type Output: ?Sized;
    fn index(&self, index: Idx) -> &Self::Output;
}

trait IndexMut<Idx>: Index<Idx> {
    fn index_mut(&mut self, index: Idx) -> &mut Self::Output;
}

```

Note that these traits take the type of the index expression as a parameter. You can index a slice with a single `usize`, referring to a single element, because slices implement `Index<usize>`. But you can refer to a subslice with an expression like `a[i..j]` because they also implement `Index<Range<usize>>`. That expression is shorthand for:

```

*a.index(std::ops::Range { start: i, end: j })

```

Rust's `HashMap` and `BTreeMap` collections let you use any hashable or ordered type as the index. The following code works because `HashMap<&str, i32>` implements `Index<&str>`:

```
use std::collections::HashMap;
let mut m = HashMap::new();
m.insert("十", 10);
m.insert("百", 100);
m.insert("千", 1000);
m.insert("万", 1_0000);
m.insert("億", 1_0000_0000);

assert_eq!(m["十"], 10);
assert_eq!(m["千"], 1000);
```

Those indexing expressions are equivalent to:

```
use std::ops::Index;
assert_eq!(*m.index("十"), 10);
assert_eq!(*m.index("千"), 1000);
```

The `Index` trait's associated type `Output` specifies what type an indexing expression produces: for our `HashMap`, the `Index` implementation's `Output` type is `i32`.

The `IndexMut` trait extends `Index` with an `index_mut` method that takes a mutable reference to `self`, and returns a mutable reference to an `Output` value. Rust automatically selects `index_mut` when the indexing expression occurs in a context where it's necessary. For example, suppose we write the following:

```
let mut desserts = vec!["HowaLon".to_string(),
                       "Soan papdi".to_string()];
desserts[0].push_str(" (fictional)");
desserts[1].push_str(" (real)");
```

Because the `push_str` method operates on `&mut self`, those last two lines are equivalent to:

```
use std::ops::IndexMut;
(*desserts.index_mut(0)).push_str(" (fictional)");
(*desserts.index_mut(1)).push_str(" (real)");
```

One limitation of `IndexMut` is that, by design, it must return a mutable reference to some value. This is why you can't use an expression like `m["十"] = 10`; to insert a value into the `HashMap` `m`: the table would need to create an entry for "十" first, with some default value, and return a mutable reference to that. But not all types have cheap default values, and some may be expensive to drop; it would be a waste to create such a value only to be immediately dropped by the assignment. (There are plans to improve this in later versions of the language.)

The most common use of indexing is for collections. For example, suppose we are working with bitmapped images, like the ones we created in the Mandelbrot set plotter in [Chapter 2](#). Recall that our program contained code like this:

```
pixels[row * bounds.0 + column] = ...;
```

It would be nicer to have an `Image<u8>` type that acts like a two-dimensional array, allowing us to access pixels without having to write out all the arithmetic:

```
image[row][column] = ...;
```

To do this, we'll need to declare a struct:

```
struct Image<P> {
    width: usize,
    pixels: Vec<P>
}

impl<P: Default + Copy> Image<P> {
    /// Create a new image of the given size.
    fn new(width: usize, height: usize) -> Image<P> {
        Image {
            width,
            pixels: vec![P::default(); width * height]
        }
    }
}
```

And here are implementations of `Index` and `IndexMut` that would fit the bill:

```
impl<P> std::ops::Index<usize> for Image<P> {
    type Output = [P];
    fn index(&self, row: usize) -> &[P] {
        let start = row * self.width;
        &self.pixels[start .. start + self.width]
    }
}

impl<P> std::ops::IndexMut<usize> for Image<P> {
    fn index_mut(&mut self, row: usize) -> &mut [P] {
        let start = row * self.width;
        &mut self.pixels[start .. start + self.width]
    }
}
```

When you index into an `Image`, you get back a slice of pixels; indexing the slice gives you an individual pixel.

Note that when we write `image[row][column]`, if `row` is out of bounds, our `.index()` method will try to index `self.pixels` out of range, triggering a panic. This is how `Index` and `IndexMut` implementations are supposed to behave: out-of-bounds access

is detected and causes a panic, the same as when you index an array, slice, or vector out of bounds.

## Other Operators

Not all operators can be overloaded in Rust. As of Rust 1.17, the error-checking `?` operator works only with `Result` values. Similarly, the logical operators `&&` and `||` are limited to Boolean values only. The `..` operator always creates `Range` values, the `&` operator always borrows references, and the `=` operator always moves or copies values. None of them can be overloaded.

The dereferencing operator, `*val`, and the dot operator for accessing fields and calling methods, as in `val.field` and `val.method()`, can be overloaded using the `Deref` and `DerefMut` traits, which are covered in the next chapter. (We did not include them here because these traits do more than just overload a few operators.)

Rust does not support overloading the function call operator, `f(x)`. Instead, when you need a callable value, you'll typically just write a closure. We'll explain how this works and cover the `Fn`, `FnMut`, and `FnOnce` special traits in [Chapter 14](#).

---

# Utility Traits

*Science is nothing else than the search to discover unity in the wild variety of nature—or, more exactly, in the variety of our experience. Poetry, painting, the arts are the same search, in Coleridge’s phrase, for unity in variety.*

— Jacob Bronowski

Apart from operator overloading, which we covered in the previous chapter, several other built-in traits let you hook into parts of the Rust language and standard library:

- You can use the `Drop` trait to clean up values when they go out of scope, like destructors in C++.
- Smart pointer types, like `Box<T>` and `Rc<T>`, can implement the `Deref` trait to make the pointer reflect the methods of the wrapped value.
- By implementing the `From<T>` and `Into<T>` traits, you can tell Rust how to convert a value from one type to another.

This chapter is a grab bag of useful traits from the Rust standard library. We’ll cover each of the traits shown in [Table 13-1](#).

There are other important standard library traits as well. We’ll cover `Iterator` and `IntoIterator` in [Chapter 15](#). The `Hash` trait, for computing hash codes, is covered in [Chapter 16](#). And a pair of traits that mark thread-safe types, `Send` and `Sync`, are covered in [Chapter 19](#).

Table 13-1. Summary of utility traits

Trait	Description
Drop	Destructors. Cleanup code that Rust runs automatically whenever a value is dropped.
Sized	Marker trait for types with a fixed size known at compile time, as opposed to types (such as slices) that are dynamically sized.
Clone	Types that support cloning values.
Copy	Marker trait for types that can be cloned simply by making a byte-for-byte copy of the memory containing the value.
Deref and DerefMut	Traits for smart pointer types.
Default	Types that have a sensible “default value.”
AsRef and AsMut	Conversion traits for borrowing one type of reference from another.
Borrow and BorrowMut	Conversion traits, like AsRef/AsMut, but additionally guaranteeing consistent hashing, ordering, and equality.
From and Into	Conversion traits for transforming one type of value into another.
ToOwned	Conversion trait for converting a reference to an owned value.

## Drop

When a value’s owner goes away, we say that Rust *drops* the value. Dropping a value entails freeing whatever other values, heap storage, and system resources the value owns. Drops occur under a variety of circumstances: when a variable goes out of scope; when an expression’s value is discarded by the `;` operator; when you truncate a vector, removing elements from its end; and so on.

For the most part, Rust handles dropping values for you automatically. For example, suppose you define the following type:

```
struct Appellation {
    name: String,
    nicknames: Vec<String>
}
```

An `Appellation` owns heap storage for the strings’ contents and the vector’s buffer of elements. Rust takes care of cleaning all that up whenever an `Appellation` is dropped, without any further coding necessary on your part. However, if you want, you can customize how Rust drops values of your type by implementing the `std::ops::Drop` trait:

```
trait Drop {
    fn drop(&mut self);
}
```

An implementation of `Drop` is analogous to a destructor in C++, or a finalizer in other languages. When a value is dropped, if it implements `std::ops::Drop`, Rust calls its



drop method, before proceeding to drop whatever values its fields or elements own, as it normally would. This implicit invocation of drop is the only way to call that method; if you try to invoke it explicitly yourself, Rust flags that as an error.

Because Rust calls `Drop::drop` on a value before dropping its fields or elements, the value the method receives is always still fully initialized. An implementation of `Drop` for our `Appellation` type can make full use of its fields:

```
impl Drop for Appellation {
    fn drop(&mut self) {
        println!("Dropping {}", self.name);
        if !self.nicknames.is_empty() {
            println!(" (AKA {})", self.nicknames.join(", "));
        }
        println!("");
    }
}
```

Given that implementation, we can write the following:

```
{
    let mut a = Appellation { name: "Zeus".to_string(),
                             nicknames: vec!["cloud collector".to_string(),
                                              "king of the gods".to_string() ] };

    println!("before assignment");
    a = Appellation { name: "Hera".to_string(), nicknames: vec![] };
    println!("at end of block");
}
```

When we assign the second `Appellation` to `a`, the first is dropped, and when we leave the scope of `a`, the second is dropped. This code prints the following:

```
before assignment
Dropping Zeus (AKA cloud collector, king of the gods)
at end of block
Dropping Hera
```

Since our `std::ops::Drop` implementation for `Appellation` does nothing but print a message, how, exactly, does its memory get cleaned up? The `Vec` type implements `Drop`, dropping each of its elements and then freeing the heap-allocated buffer they occupied. A `String` uses a `Vec<u8>` internally to hold its text, so `String` need not implement `Drop` itself; it lets its `Vec` take care of freeing the characters. The same principle extends to `Appellation` values: when one gets dropped, in the end it is `Vec`'s implementation of `Drop` that actually takes care of freeing each of the strings' contents, and finally freeing the buffer holding the vector's elements. As for the memory that holds the `Appellation` value itself, it too has some owner, perhaps a local variable or some data structure, which is responsible for freeing it.

If a variable's value gets moved elsewhere, so that the variable is uninitialized when it goes out of scope, then Rust will not try to drop that variable: there is no value in it to drop.

This principle holds even when a variable may or may not have had its value moved away, depending on the flow of control. In cases like this, Rust keeps track of the variable's state with an invisible flag indicating whether the variable's value needs to be dropped or not:

```
let p;
{
    let q = Appellation { name: "Cardamine hirsuta".to_string(),
                        nicknames: vec!["shotweed".to_string(),
                                       "bittercress".to_string()] };

    if complicated_condition() {
        p = q;
    }
}
println!("Sproing! What was that?");
```

Depending on whether `complicated_condition` returns `true` or `false`, either `p` or `q` will end up owning the `Appellation`, with the other uninitialized. Where it lands determines whether it is dropped before or after the `println!`, since `q` goes out of scope before the `println!`, and `p` after. Although a value may be moved from place to place, Rust drops it only once.

You usually won't need to implement `std::ops::Drop` unless you're defining a type that owns resources Rust doesn't already know about. For example, on Unix systems, Rust's standard library uses the following type internally to represent an operating system file descriptor:

```
struct FileDesc {
    fd: c_int,
}
```

The `fd` field of a `FileDesc` is simply the number of the file descriptor that should be closed when the program is done with it; `c_int` is an alias for `i32`. The standard library implements `Drop` for `FileDesc` as follows:

```
impl Drop for FileDesc {
    fn drop(&mut self) {
        let _ = unsafe { libc::close(self.fd) };
    }
}
```

Here, `libc::close` is the Rust name for the C library's `close` function. Rust code may call C functions only within `unsafe` blocks, so the library uses one here.

If a type implements `Drop`, it cannot implement the `Copy` trait. If a type is `Copy`, that means that simple byte-for-byte duplication is sufficient to produce an independent

copy of the value. But it is typically a mistake to call the same drop method more than once on the same data.

The standard prelude includes a function to drop a value, `drop`, but its definition is anything but magical:

```
fn drop<T>(_x: T) { }
```

In other words, it receives its argument by value, taking ownership from the caller—and then does nothing with it. Rust drops the value of `_x` when it goes out of scope, as it would for any other variable.

## Sized

A *sized type* is one whose values all have the same size in memory. Almost all types in Rust are sized: every `u64` takes eight bytes, every `(f32, f32, f32)` tuple twelve. Even enums are sized: no matter which variant is actually present, an enum always occupies enough space to hold its largest variant. And although a `Vec<T>` owns a heap-allocated buffer whose size can vary, the `Vec` value itself is a pointer to the buffer, its capacity, and its length, so `Vec<T>` is a sized type.

However, Rust also has a few *unsized types* whose values are not all the same size. For example, the string slice type `str` (note, without an `&`) is unsized. The string literals "diminutive" and "big" are references to `str` slices that occupy ten and three bytes. Both are shown in [Figure 13-1](#). Array slice types like `[T]` (again, without an `&`) are unsized, too: a shared reference like `&[u8]` can point to a `[u8]` slice of any size. Because the `str` and `[T]` types denote sets of values of varying sizes, they are unsized types.

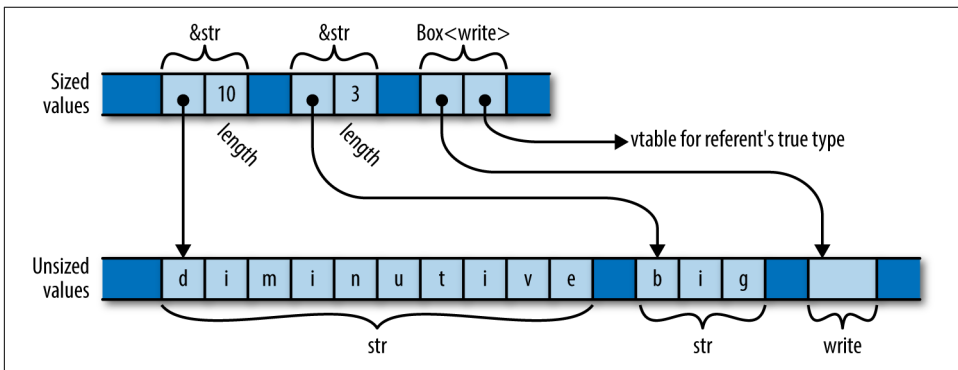

Figure 13-1. References to unsized values

The other common kind of unsized type in Rust is the referent of a trait object. As we explained in [“Trait Objects” on page 238](#), a trait object is a pointer to some value that

implements a given trait. For example, the types `&std::io::Write` and `Box<std::io::Write>` are pointers to some value that implements the `Write` trait. The referent might be a file, or a network socket, or some type of your own for which you have implemented `Write`. Since the set of types that implement `Write` is open-ended, `Write` considered as a type is *unsized*: its values have various sizes.

Rust can't store unsized values in variables or pass them as arguments. You can only deal with them through pointers like `&str` or `Box<Write>`, which themselves are sized. As shown in [Figure 13-1](#), a pointer to an unsized value is always a *fat pointer*, two words wide: a pointer to a slice also carries the slice's length, and a trait object also carries a pointer to a vtable of method implementations.

Trait objects and pointers to slices are nicely symmetrical. In both cases, the type lacks information necessary to use it: you can't index a `[u8]` without knowing its length, nor can you invoke a method on a `Box<Write>` without knowing the implementation of `Write` appropriate to the specific value it refers to. And in both cases, the fat pointer fills in the information missing from the type, carrying a length or a vtable pointer. The omitted static information is replaced with dynamic information.

All sized types implement the `std::marker::Sized` trait, which has no methods or associated types. Rust implements it automatically for all types to which it applies; you can't implement it yourself. The only use for `Sized` is as a bound for type variables: a bound like `T: Sized` requires `T` to be a type whose size is known at compile time. Traits of this sort are called *marker traits*, because the Rust language itself uses them to mark certain types as having characteristics of interest.

Since unsized types are so limited, most generic type variables should be restricted to `Sized` types. In fact, this is necessary so often that it is the implicit default in Rust: if you write `struct S<T> { ... }`, Rust understands you to mean `struct S<T: Sized> { ... }`. If you do not want to constrain `T` this way, you must explicitly opt out, writing `struct S<T: ?Sized> { ... }`. The `?Sized` syntax is specific to this case, and means “not necessarily `Sized`.” For example, if you write `struct S<T: ?Sized> { b: Box<T> }`, then Rust will allow you to write `S<str>` and `S<Write>`, where the box becomes a fat pointer, as well as `S<i32>` and `S<String>`, where the box is an ordinary pointer.

Despite their restrictions, unsized types make Rust's type system work more smoothly. Reading the standard library documentation, you will occasionally come across a `?Sized` bound on a type variable; this almost always means that the given type is only pointed to, and allows the associated code to work with slices and trait objects as well as ordinary values. When a type variable has the `?Sized` bound, people often say it is *questionably sized*: it might be `Sized`, or it might not.

Aside from slices and trait objects, there is one more kind of unsized type. A struct type's last field (but only its last) may be unsized, and such a struct is itself unsized. For example, an `Rc<T>` reference-counted pointer is implemented internally as a pointer to the private type `RcBox<T>`, which stores the reference count alongside the `T`. Here's a simplified definition of `RcBox`:

```
struct RcBox<T: ?Sized> {
    ref_count: usize,
    value: T,
}
```

The `value` field is the `T` to which `Rc<T>` is counting references; `Rc<T>` dereferences to a pointer to this field. The `ref_count` field holds the reference count.

You can use `RcBox` with sized types, like `RcBox<String>`; the result is a sized struct type. Or you can use it with unsized types, like `RcBox<std::fmt::Display>` (where `Display` is the trait for types that can be formatted by `println!` and similar macros); `RcBox<Display>` is an unsized struct type.

You can't build an `RcBox<Display>` value directly. Instead, you must first create an ordinary, sized `RcBox` whose `value` type implements `Display`, like `RcBox<String>`. Rust then lets you convert a reference `&RcBox<String>` to a fat reference `&RcBox<Display>`:

```
let boxed_lunch: RcBox<String> = RcBox {
    ref_count: 1,
    value: "lunch".to_string()
};

use std::fmt::Display;
let boxed_displayable: &RcBox<Display> = &boxed_lunch;
```

This conversion happens implicitly when passing values to functions, so you can pass a `&RcBox<String>` to a function that expects an `&RcBox<Display>`:

```
fn display(boxed: &RcBox<Display>) {
    println!("For your enjoyment: {}", &boxed.value);
}

display(&boxed_lunch);
```

This produces the following output:

```
For your enjoyment: lunch
```

## Clone

The `std::clone::Clone` trait is for types that can make copies of themselves. `Clone` is defined as follows:

```

trait Clone: Sized {
    fn clone(&self) -> Self;
    fn clone_from(&mut self, source: &Self) {
        *self = source.clone()
    }
}

```

The `clone` method should construct an independent copy of `self` and return it. Since this method's return type is `Self`, and functions may not return unsized values, the `Clone` trait itself extends the `Sized` trait: this has the effect of bounding implementations' `Self` types to be `Sized`.

Cloning a value usually entails allocating copies of anything it owns, as well, so a `clone` can be expensive, in both time and memory. For example, cloning a `Vec<String>` not only copies the vector, but also copies each of its `String` elements. This is why Rust doesn't just clone values automatically, but instead requires you to make an explicit method call. The reference-counted pointer types like `Rc<T>` and `Arc<T>` are exceptions: cloning one of these simply increments the reference count and hands you a new pointer.

The `clone_from` method modifies `self` into a copy of `source`. The default definition of `clone_from` simply clones `source`, and then moves that into `*self`. This always works, but for some types, there is a faster way to get the same effect. For example, suppose `s` and `t` are `Strings`. The statement `s = t.clone();` must clone `t`, drop the old value of `s`, and then move the cloned value into `s`; that's one heap allocation, and one heap deallocation. But if the heap buffer belonging to the original `s` has enough capacity to hold `t`'s contents, no allocation or deallocation is necessary: you can simply copy `t`'s text into `s`'s buffer, and adjust the length. In generic code, you should use `clone_from` whenever possible, to permit this optimization when it is available.

If your `Clone` implementation simply applies `clone` to each field or element of your type, and then constructs a new value from those clones, and the default definition of `clone_from` is good enough, then Rust will implement that for you: simply put `#[derive(Clone)]` above your type definition.

Pretty much every type in the standard library that makes sense to copy implements `Clone`. Primitive types like `bool` and `i32` do. Container types like `String`, `Vec<T>`, and `HashMap` do, too. Some types don't make sense to copy, like `std::sync::Mutex`; those don't implement `Clone`. Some types like `std::fs::File` can be copied, but the copy might fail if the operating system doesn't have the necessary resources; these types don't implement `Clone`, since `clone` must be infallible. Instead, `std::fs::File` provides a `try_clone` method, which returns a `std::io::Result<File>`, which can report a failure.

# Copy

In [Chapter 4](#), we explained that, for most types, assignment moves values, rather than copying them. Moving values makes it much simpler to track the resources they own. But in [“Copy Types: The Exception to Moves” on page 86](#), we pointed out the exception: simple types that don’t own any resources can be Copy types, where assignment makes a copy of the source, rather than moving the value and leaving the source uninitialized.

At that time, we left it vague exactly what Copy was, but now we can tell you: a type is Copy if it implements the `std::marker::Copy` marker trait, which is defined as follows:

```
trait Copy: Clone { }
```

This is certainly easy to implement for your own types:

```
impl Copy for MyType { }
```

But because Copy is a marker trait with special meaning to the language, Rust permits a type to implement Copy only if a shallow byte-for-byte copy is all it needs. Types that own any other resources, like heap buffers or operating system handles, cannot implement Copy.

Any type that implements the Drop trait cannot be Copy. Rust presumes that if a type needs special clean-up code, it must also require special copying code, and thus can’t be Copy.

As with Clone, you can ask Rust to derive Copy for you, using `#[derive(Copy)]`. You will often see both derived at once, with `#[derive(Copy, Clone)]`.

Think carefully before making a type Copy. Although doing so makes the type easier to use, it places heavy restrictions on its implementation. Implicit copies can also be expensive. We explain these factors in detail in [“Copy Types: The Exception to Moves” on page 86](#).

## Deref and DerefMut

You can specify how dereferencing operators like `*` and `.` behave on your types by implementing the `std::ops::Deref` and `std::ops::DerefMut` traits. Pointer types like `Box<T>` and `Rc<T>` implement these traits so that they can behave as Rust’s built-in pointer types do. For example, if you have a `Box<Complex>` value `b`, then `*b` refers to the `Complex` value that `b` points to, and `b.re` refers to its real component. If the context assigns or borrows a mutable reference to the referent, Rust uses the `DerefMut` (“dereference mutably”) trait; otherwise, read-only access is enough, and it uses `Deref`.

The traits are defined like this:

```
trait Deref {
    type Target: ?Sized;
    fn deref(&self) -> &Self::Target;
}

trait DerefMut: Deref {
    fn deref_mut(&mut self) -> &mut Self::Target;
}
```

The `deref` and `deref_mut` methods take a `&Self` reference and return a `&Self::Target` reference. `Target` should be something that `Self` contains, owns, or refers to: for `Box<Complex>` the `Target` type is `Complex`. Note that `DerefMut` extends `Deref`: if you can dereference something and modify it, certainly you should be able to borrow a shared reference to it as well. Since the methods return a reference with the same lifetime as `&self`, `self` remains borrowed for as long as the returned reference lives.

The `Deref` and `DerefMut` traits play another role as well. Since `deref` takes a `&Self` reference and returns a `&Self::Target` reference, Rust uses this to automatically convert references of the former type into the latter. In other words, if inserting a `deref` call would prevent a type mismatch, Rust inserts one for you. Implementing `DerefMut` enables the corresponding conversion for mutable references. These are called the *deref coercions*: one type is being “coerced” into behaving as another.

Although the `deref` coercions aren’t anything you couldn’t write out explicitly yourself, they’re convenient:

- If you have some `Rc<String>` value `r`, and want to apply `String::find` to it, you can simply write `r.find('?')`, instead of `(*r).find('?')`: the method call implicitly borrows `r`, and `&Rc<String>` coerces to `&String`, because `Rc<T>` implements `Deref<Target=T>`.
- You can use methods like `split_at` on `String` values, even though `split_at` is a method of the `str` slice type, because `String` implements `Deref<Target=str>`. There’s no need for `String` to reimplement all of `str`’s methods, since you can coerce a `&str` from a `&String`.
- If you have a vector of bytes `v`, and you want to pass it to a function that expects a byte slice `&[u8]`, you can simply pass `&v` as the argument, since `Vec<T>` implements `Deref<Target=[T]>`.

Rust will apply several `deref` coercions in succession if necessary. For example, using the coercions mentioned before, you can apply `split_at` directly to an `Rc<String>`, since `&Rc<String>` dereferences to `&String`, which dereferences to `&str`, which has the `split_at` method.



For example, suppose you have the following type:

```
struct Selector<T> {  
    /// Elements available in this `Selector`.  
    elements: Vec<T>,  
  
    /// The index of the "current" element in `elements`. A `Selector`  
    /// behaves like a pointer to the current element.  
    current: usize  
}
```

To make the Selector behave as the doc comment claims, you must implement Deref and DerefMut for the type:

```
use std::ops::{Deref, DerefMut};  
  
impl<T> Deref for Selector<T> {  
    type Target = T;  
    fn deref(&self) -> &T {  
        &self.elements[self.current]  
    }  
}  
  
impl<T> DerefMut for Selector<T> {  
    fn deref_mut(&mut self) -> &mut T {  
        &mut self.elements[self.current]  
    }  
}
```

Given those implementations, you can use a Selector like this:

```
let mut s = Selector { elements: vec!['x', 'y', 'z'],  
                      current: 2 };  
  
// Because `Selector` implements `Deref`, we can use the `*` operator to  
// refer to its current element.  
assert_eq!(*s, 'z');  
  
// Assert that 'z' is alphabetic, using a method of `char` directly on a  
// `Selector`, via deref coercion.  
assert!(s.is_alphabetic());  
  
// Change the 'z' to a 'w', by assigning to the `Selector`'s referent.  
*s = 'w';  
  
assert_eq!(s.elements, ['x', 'y', 'w']);
```

The Deref and DerefMut traits are designed for implementing smart pointer types, like Box, Rc, and Arc, and types that serve as owning versions of something you would also frequently use by reference, the way Vec<T> and String serve as owning versions of [T] and str. You should not implement Deref and DerefMut for a type just to make the Target type's methods appear on it automatically, the way a C++

base class's methods are visible on a subclass. This will not always work as you expect, and can be confusing when it goes awry.

The deref coercions come with a caveat that can cause some confusion: Rust applies them to resolve type conflicts, but not to satisfy bounds on type variables. For example, the following code works fine:

```
let s = Selector { elements: vec!["good", "bad", "ugly"],
                  current: 2 };

fn show_it(thing: &str) { println!("{}", thing); }
show_it(&s);
```

In the call `show_it(&s)`, Rust sees an argument of type `&Selector<&str>` and a parameter of type `&str`, finds the `Deref<Target=&str>` implementation, and rewrites the call to `show_it(s.deref())`, just as needed.

However, if you change `show_it` into a generic function, Rust is suddenly no longer cooperative:

```
use std::fmt::Display;
fn show_it_generic<T: Display>(thing: T) { println!("{}", thing); }
show_it_generic(&s);
```

Rust complains:

```
error[E0277]: the trait bound `Selector<&str>: Display` is not satisfied
  |
542 |         show_it_generic(&s);
    |         ^^^^^^^^^^^^^^^^^ trait `Selector<&str>: Display` not satisfied
```

This can be bewildering: How could making a function generic introduce an error? True, `Selector<&str>` does not implement `Display` itself, but it dereferences to `&str`, which certainly does.

Since you're passing an argument of type `&Selector<&str>`, and the function's parameter type is `&T`, the type variable `T` must be `Selector<&str>`. Then, Rust checks whether the bound `T: Display` is satisfied: since it does not apply deref coercions to satisfy bounds on type variables, this check fails.

To work around this problem, you can spell out the coercion using the `as` operator:

```
show_it_generic(&s as &str);
```

## Default

Some types have a reasonably obvious default value: the default vector or string is empty, the default number is zero, the default `Option` is `None`, and so on. Types like this can implement the `std::default::Default` trait:

```
trait Default {
    fn default() -> Self;
}
```

The `default` method simply returns a fresh value of type `Self`. `String`'s implementation of `Default` is straightforward:

```
impl Default for String {
    fn default() -> String {
        String::new()
    }
}
```

All of Rust's collection types—`Vec`, `HashMap`, `BinaryHeap`, and so on—implement `Default`, with `default` methods that return an empty collection. This is helpful when you need to build a collection of values, but want to let your caller decide exactly what sort of collection to build. For example, the `Iterator` trait's `partition` method splits the values the iterator produces into two collections, using a closure to decide where each value goes:

```
use std::collections::HashSet;
let squares = [4, 9, 16, 25, 36, 49, 64];
let (powers_of_two, impure): (HashSet<i32>, HashSet<i32>)
    = squares.iter().partition(|&n| n & (n-1) == 0);

assert_eq!(powers_of_two.len(), 3);
assert_eq!(impure.len(), 4);
```

The closure `|&n| n & (n-1) == 0` uses some bit-fiddling to recognize numbers that are powers of two, and `partition` uses that to produce two `HashSet`s. But of course, `partition` isn't specific to `HashSet`s; you can use it to produce any sort of collection you like, as long as the collection type implements `Default`, to produce an empty collection to start with, and `Extend<T>`, to add a `T` to the collection. `String` implements `Default` and `Extend<char>`, so you can write:

```
let (upper, lower): (String, String)
    = "Great Teacher Onizuka".chars().partition(|&c| c.is_uppercase());
assert_eq!(upper, "GTO");
assert_eq!(lower, "reat eacher nizuka");
```

Another common use of `Default` is to produce default values for structs that represent a large collection of parameters, most of which you won't usually need to change. For example, the `glium` crate provides Rust bindings for the powerful and complex OpenGL graphics library. The `glium::DrawParameters` struct includes 22 fields, each controlling a different detail of how OpenGL should render some bit of graphics. The `glium` `draw` function expects a `DrawParameters` struct as an argument. Since `DrawParameters` implements `Default`, you can create one to pass to `draw`, mentioning only those fields you want to change:

```

let params = glium::DrawParameters {
    line_width: Some(0.02),
    point_size: Some(0.02),
    .. Default::default()
};

target.draw(..., &params).unwrap();

```

This calls `Default::default()` to create a `DrawParameters` value initialized with the default values for all its fields, and then uses the `..` syntax for structs to create a new one with the `line_width` and `point_size` fields changed, ready for you to pass it to `target.draw`.

If a type `T` implements `Default`, then the standard library implements `Default` automatically for `Rc<T>`, `Arc<T>`, `Box<T>`, `Cell<T>`, `RefCell<T>`, `Cow<T>`, `Mutex<T>`, and `RwLock<T>`. The default value for the type `Rc<T>`, for example, is an `Rc` pointing to the default value for type `T`.

If all the element types of a tuple type implement `Default`, then the tuple type does too, defaulting to a tuple holding each element's default value.

Rust does not implicitly implement `Default` for struct types, but if all of a struct's fields implement `Default`, you can implement `Default` for the struct automatically using `#[derive(Default)]`.

The default value of any `Option<T>` is `None`.

## AsRef and AsMut

When a type implements `AsRef<T>`, that means you can borrow a `&T` from it efficiently. `AsMut` is the analogue for mutable references. Their definitions are as follows:

```

trait AsRef<T: ?Sized> {
    fn as_ref(&self) -> &T;
}

trait AsMut<T: ?Sized> {
    fn as_mut(&mut self) -> &mut T;
}

```

So, for example, `Vec<T>` implements `AsRef<[T]>`, and `String` implements `AsRef<str>`. You can also borrow a `String`'s contents as an array of bytes, so `String` implements `AsRef<[u8]>` as well.

`AsRef` is typically used to make functions more flexible in the argument types they accept. For example, the `std::fs::File::open` function is declared like this:

```

fn open<P: AsRef<Path>>(path: P) -> Result<File>

```

What `open` really wants is a `&Path`, the type representing a filesystem path. But with this signature, `open` accepts anything it can borrow a `&Path` from—that is, anything that implements `AsRef<Path>`. Such types include `String` and `str`, the operating system interface string types `OsString` and `OsStr`, and of course `PathBuf` and `Path`; see the library documentation for the full list. This is what allows you to pass string literals to `open`:

```
let dot_emacs = std::fs::File::open("/home/jimb/.emacs");
```

All of the standard library’s filesystem access functions accept path arguments this way. For callers, the effect resembles that of an overloaded function in C++, although Rust takes a different approach toward establishing which argument types are acceptable.

But this can’t be the whole story. A string literal is a `&str`, but the type that implements `AsRef<Path>` is `str`, without an `&`. And as we explained in “[Deref and DerefMut](#)” on page 289, Rust doesn’t try deref coercions to satisfy type variable bounds, so they won’t help here either.

Fortunately, the standard library includes the blanket implementation:

```
impl<'a, T, U> AsRef<U> for &'a T
  where T: AsRef<U>,
         T: ?Sized, U: ?Sized
{
  fn as_ref(&self) -> &U {
    (*self).as_ref()
  }
}
```

In other words, for any types `T` and `U`, if `T: AsRef<U>`, then `&T: AsRef<U>` as well: simply follow the reference and proceed as before. In particular, since `str: AsRef<Path>`, then `&str: AsRef<Path>` as well. In a sense, this is a way to get a limited form of deref coercion in checking `AsRef` bounds on type variables.

You might assume that, if a type implements `AsRef<T>`, it should also implement `AsMut<T>`. However, there are cases where this isn’t appropriate. For example, we’ve mentioned that `String` implements `AsRef<[u8]>`; this makes sense, as each `String` certainly has a buffer of bytes that can be useful to access as binary data. However, `String` further guarantees that those bytes are a well-formed UTF-8 encoding of Unicode text; if `String` implemented `AsMut<[u8]>`, that would let callers change the `String`’s bytes to anything they wanted, and you could no longer trust a `String` to be well-formed UTF-8. It only makes sense for a type to implement `AsMut<T>` if modifying the given `T` cannot violate the type’s invariants.

Although `AsRef` and `AsMut` are pretty simple, providing standard, generic traits for reference conversion avoids the proliferation of more specific conversion traits. You

should avoid defining your own `AsFoo` traits when you could just implement `AsRef<Foo>`.

## Borrow and BorrowMut

The `std::borrow::Borrow` trait is similar to `AsRef`: if a type implements `Borrow<T>`, then its `borrow` method efficiently borrows a `&T` from it. But `Borrow` imposes more restrictions: a type should implement `Borrow<T>` only when a `&T` hashes and compares the same way as the value it's borrowed from. (Rust doesn't enforce this; it's just the documented intent of the trait.) This makes `Borrow` valuable in dealing with keys in hash tables and trees, or when dealing with values that will be hashed or compared for some other reason.

This distinction matters when borrowing from `Strings`, for example: `String` implements `AsRef<&str>`, `AsRef<[u8]>`, and `AsRef<Path>`, but those three target types will generally have different hash values. Only the `&str` slice is guaranteed to hash like the equivalent `String`, so `String` implements only `Borrow<str>`.

`Borrow`'s definition is identical to that of `AsRef`; only the names have been changed:

```
trait Borrow<Borrowed: ?Sized> {  
    fn borrow(&self) -> &Borrowed;  
}
```

`Borrow` is designed to address a specific situation with generic hash tables and other associative collection types. For example, suppose you have a `std::collections::HashMap<String, i32>`, mapping strings to numbers. This table's keys are `Strings`; each entry owns one. What should the signature of the method that looks up an entry in this table be? Here's a first attempt:

```
impl HashMap<K, V> where K: Eq + Hash  
{  
    fn get(&self, key: K) -> Option<&V> { ... }  
}
```

This makes sense: to look up an entry, you must provide a key of the appropriate type for the table. But in this case, `K` is `String`; this signature would force you to pass a `String` by value to every call to `get`, which is clearly wasteful. You really just need a reference to the key:

```
impl HashMap<K, V> where K: Eq + Hash  
{  
    fn get(&self, key: &K) -> Option<&V> { ... }  
}
```

This is slightly better, but now you have to pass the key as a `&String`, so if you wanted to look up a constant string, you'd have to write:

```
hashtable.get(&"twenty-two".to_string())
```

This is ridiculous: it allocates a `String` buffer on the heap and copies the text into it, just so it can borrow it as a `&String`, pass it to `get`, and then drop it.

It should be good enough to pass anything that can be hashed and compared with our key type; a `&str` should be perfectly adequate, for example. So here's the final iteration, which is what you'll find in the standard library:

```
impl HashMap<K, V> where K: Eq + Hash
{
    fn get<Q: ?Sized>(&self, key: &Q) -> Option<&V>
        where K: Borrow<Q>,
              Q: Eq + Hash
    { ... }
}
```

In other words, if you can borrow an entry's key as a `&Q`, and the resulting reference hashes and compares just the way the key itself would, then clearly `&Q` ought to be an acceptable key type. Since `String` implements `Borrow<str>` and `Borrow<String>`, this final version of `get` allows you to pass either `&String` or `&str` as a key, as needed.

`Vec<T>` and `[T: N]` implement `Borrow<[T]>`. Every string-like type allows borrowing its corresponding slice type: `String` implements `Borrow<str>`, `PathBuf` implements `Borrow<Path>`, and so on. And all the standard library's associative collection types use `Borrow` to decide which types can be passed to their lookup functions.

The standard library includes a blanket implementation so that every type `T` can be borrowed from itself: `T: Borrow<T>`. This ensures that `&K` is always an acceptable type for looking up entries in a `HashMap<K, V>`.

As a convenience, every `&mut T` type also implements `Borrow<T>`, returning a shared reference `&T` as usual. This allows you to pass mutable references to collection lookup functions without having to reborrow a shared reference, emulating Rust's usual implicit coercion from mutable references to shared references.

The `BorrowMut` trait is the analogue of `Borrow` for mutable references:

```
trait BorrowMut<Borrowed: ?Sized>: Borrow<Borrowed> {
    fn borrow_mut(&mut self) -> &mut Borrowed;
}
```

The same expectations described for `Borrow` apply to `BorrowMut` as well.

## From and Into

The `std::convert::From` and `std::convert::Into` traits represent conversions that consume a value of one type, and return a value of another. Whereas the `AsRef` and `AsMut` traits borrow a reference of one type from another, `From` and `Into` take owner-

ship of their argument, transform it, and then return ownership of the result back to the caller.

Their definitions are nicely symmetrical:

```
trait Into<T>: Sized {
    fn into(self) -> T;
}

trait From<T>: Sized {
    fn from(T) -> Self;
}
```

The standard library automatically implements the trivial conversion from each type to itself: every type `T` implements `From<T>` and `Into<T>`.

Although the traits simply provide two ways to do the same thing, they lend themselves to different uses.

You generally use `Into` to make your functions more flexible in the arguments they accept. For example, if you write:

```
use std::net::Ipv4Addr;
fn ping<A>(address: A) -> std::io::Result<bool>
    where A: Into<Ipv4Addr>
{
    let ipv4_address = address.into();
    ...
}
```

then `ping` can accept not just an `Ipv4Addr` as an argument, but also a `u32` or a `[u8; 4]` array, since those types both conveniently happen to implement `Into<Ipv4Addr>`. (It's sometimes useful to treat an IPv4 address as a single 32-bit value, or an array of four bytes.) Because the only thing `ping` knows about `address` is that it implements `Into<Ipv4Addr>`, there's no need to specify which type you want when you call `into`; there's only one that could possibly work, so type inference fills it in for you.

As with `AsRef` in the previous section, the effect is much like that of overloading a function in C++. With the definition of `ping` from before, we can make any of these calls:

```
println!("{:?}", ping(Ipv4Addr::new(23, 21, 68, 141))); // pass an Ipv4Addr
println!("{:?}", ping([66, 146, 219, 98]));           // pass a [u8; 4]
println!("{:?}", ping(0xd076eb94_u32));             // pass a u32
```

The `From` trait, however, plays a different role. The `from` method serves as a generic constructor for producing an instance of a type from some other single value. For example, rather than `Ipv4Addr` having two methods named `from_array` and `from_u32`, it simply implements `From<[u8; 4]>` and `From<u32>`, allowing us to write:



```
let addr1 = Ipv4Addr::from([66, 146, 219, 98]);
let addr2 = Ipv4Addr::from(0xd076eb94_u32);
```

We can let type inference sort out which implementation applies.

Given an appropriate `From` implementation, the standard library automatically implements the corresponding `Into` trait. When you define your own type, if it has single-argument constructors, you should write them as implementations of `From<T>` for the appropriate types; you'll get the corresponding `Into` implementations for free.

Because the `from` and `into` conversion methods take ownership of their arguments, a conversion can reuse the original value's resources to construct the converted value. For example, suppose you write:

```
let text = "Beautiful Soup".to_string();
let bytes: Vec<u8> = text.into();
```

The implementation of `Into<Vec<u8>>` for `String` simply takes the `String`'s heap buffer and repurposes it, unchanged, as the returned vector's element buffer. The conversion has no need to allocate or copy the text. This is another case where moves enable efficient implementations.

These conversions also provide a nice way to relax a value of a constrained type into something more flexible, without weakening the constrained type's guarantees. For example, a `String` guarantees that its contents are always valid UTF-8; its mutating methods are carefully restricted to ensure that nothing you can do will ever introduce bad UTF-8. But this example efficiently “demotes” a `String` to a block of plain bytes that you can do anything you like with: perhaps you're going to compress it, or combine it with other binary data that isn't UTF-8. Because `into` takes its argument by value, `text` is no longer initialized after the conversion, meaning that we can freely access the former `String`'s buffer without being able to corrupt any extant `String`.

However, cheap conversions are not part of `Into` and `From`'s contract. Whereas `AsRef` and `AsMut` conversions are expected to be cheap, `From` and `Into` conversions may allocate, copy, or otherwise process the value's contents. For example, `String` implements `From<&str>`, which copies the string slice into a new heap-allocated buffer for the `String`. And `std::collections::BinaryHeap<T>` implements `From<Vec<T>>`, which compares and reorders the elements according to its algorithm's requirements.

Note that `From` and `Into` are restricted to conversions that never fail. The methods' type signatures don't provide any way to indicate that a given conversion didn't work out. To provide fallible conversions into or out of your types, it's best to have a function or method that returns a `Result` type.

Before `From` and `Into` were added to the standard library, Rust code was full of ad hoc conversion traits and construction methods, each specific to a single type. `From` and

Into codify conventions that you can follow to make your types easier to use, since your users are already familiar with them.

## ToOwned

Given a reference, the usual way to produce an owned copy of its referent is to call `clone`, assuming the type implements `std::clone::Clone`. But what if you want to clone a `&str` or a `&[i32]`? What you probably want is a `String` or a `Vec<i32>`, but `Clone`'s definition doesn't permit that: by definition, cloning a `&T` must always return a value of type `T`, and `str` and `[u8]` are unsized; they aren't even types that a function could return.

The `std::borrow::ToOwned` trait provides a slightly looser way to convert a reference to an owned value:

```
trait ToOwned {  
    type Owned: Borrow<Self>;  
    fn to_owned(&self) -> Self::Owned;  
}
```

Unlike `clone`, which must return exactly `Self`, `to_owned` can return anything you could borrow a `&Self` from: the `Owned` type must implement `Borrow<Self>`. You can borrow a `&[T]` from a `Vec<T>`, so `[T]` can implement `ToOwned<Owned=Vec<T>>`, as long as `T` implements `Clone`, so that we can copy the slice's elements into the vector. Similarly, `str` implements `ToOwned<Owned=String>`, `Path` implements `ToOwned<Owned=PathBuf>`, and so on.

## Borrow and ToOwned at Work: The Humble Cow

Making good use of Rust involves thinking through questions of ownership, like whether a function should receive a parameter by reference or by value. Usually you can settle on one approach or the other, and the parameter's type reflects your decision. But in some cases you cannot decide whether to borrow or own until the program is running; the `std::borrow::Cow` type (for "clone on write") provides one way to do this.

Its definition is shown here:

```
enum Cow<'a, B: ?Sized + 'a>  
    where B: ToOwned  
{  
    Borrowed(&'a B),  
    Owned(<B as ToOwned>::Owned),  
}
```

A `Cow<B>` either borrows a shared reference to a `B`, or owns a value from which we could borrow such a reference. Since `Cow` implements `Deref`, you can call methods on

it as if it were a shared reference to a B: if it's Owned, it borrows a shared reference to the owned value; and if it's Borrowed, it just hands out the reference it's holding.

You can also get a mutable reference to a Cow's value by calling its `to_mut` method, which returns a `&mut B`. If the Cow happens to be `Cow::Borrowed`, `to_mut` simply calls the reference's `to_owned` method to get its own copy of the referent, changes the Cow into a `Cow::Owned`, and borrows a mutable reference to the newly owned value. This is the "clone on write" behavior the type's name refers to.

Similarly, Cow has an `into_owned` method that promotes the reference to an owned value if necessary, and then returns it, moving ownership to the caller and consuming the Cow in the process.

One common use for Cow is to return either a statically allocated string constant or a computed string. For example, suppose you need to convert an error enum to a message. Most of the variants can be handled with fixed strings, but some of them have additional data that should be included in the message. You can return a `Cow<'static, str>`:

```
use std::path::PathBuf;
use std::borrow::Cow;
fn describe(error: &Error) -> Cow<'static, str> {
    match *error {
        Error::OutOfMemory => "out of memory".into(),
        Error::StackOverflow => "stack overflow".into(),
        Error::MachineOnFire => "machine on fire".into(),
        Error::Unfathomable => "machine bewildered".into(),
        Error::FileNotFound(ref path) => {
            format!("file not found: {}", path.display()).into()
        }
    }
}
```

This code uses Cow's implementation of Into to construct the values. Most arms of this match statement return a `Cow::Borrowed` referring to a statically allocated string. But when we get a `FileNotFound` variant, we use `format!` to construct a message incorporating the given filename. This arm of the match statement produces a `Cow::Owned` value.

Callers of `describe` that don't need to change the value can simply treat the Cow as a `&str`:

```
println!("Disaster has struck: {}", describe(&error));
```

Callers who do need an owned value can readily produce one:

```
let mut log: Vec<String> = Vec::new();
...
log.push(describe(&error).into_owned());
```

Using Cow helps describe and its callers put off allocation until the moment it becomes necessary.

## CHAPTER 14

# Closures

---

*Save the environment! Create a closure today!*

— Cormac Flanagan

Sorting a vector of integers is easy.

```
integers.sort();
```

It is, therefore, a sad fact that when we want some data sorted, it's hardly ever a vector of integers. We typically have records of some kind, and the built-in `sort` method typically does not work:

```
struct City {
    name: String,
    population: i64,
    country: String,
    ...
}

fn sort_cities(cities: &mut Vec<City>) {
    cities.sort(); // error: how do you want them sorted?
}
```

Rust complains that `City` does not implement `std::cmp::Ord`. We need to specify the sort order, like this:

```
/// Helper function for sorting cities by population.
fn city_population_descending(city: &City) -> i64 {
    -city.population
}

fn sort_cities(cities: &mut Vec<City>) {
    cities.sort_by_key(city_population_descending); // ok
}
```

The helper function, `city_population_descending`, takes a `City` record and extracts the *key*, the field by which we want to sort our data. (It returns a negative number because `sort` arranges numbers in increasing order, and we want decreasing order: the most populous city first.) The `sort_by_key` method takes this key-function as a parameter.

This works fine, but it's more concise to write the helper function as a *closure*, an anonymous function expression:

```
fn sort_cities(cities: &mut Vec<City>) {
    cities.sort_by_key(|city| -city.population);
}
```

The closure here is `|city| -city.population`. It takes an argument `city` and returns `-city.population`. Rust infers the argument type and return type from how the closure is used.

Other examples of standard library features that accept closures include:

- Iterator methods such as `map` and `filter`, for working with sequential data. We'll cover these methods in [Chapter 15](#).
- Threading APIs like `thread::spawn`, which starts a new system thread. Concurrency is all about moving work to other threads, and closures conveniently represent units of work. We'll cover these features in [Chapter 19](#).
- Some methods that conditionally need to compute a default value, like the `or_insert_with` method of `HashMap` entries. This method either gets or creates an entry in a `HashMap`, and it's used when the default value is expensive to compute. The default value is passed in as a closure that is called only if a new entry must be created.

Of course, anonymous functions are everywhere these days, even in languages like Java, C#, Python, and C++ that didn't originally have them. From now on we'll assume you've seen anonymous functions before and focus on what makes Rust's closures a little different. In this chapter, you'll learn how to use closures with standard library methods, how a closure can "capture" variables in its scope, how to write your own functions and methods that take closures as arguments, and how to store closures for later use as callbacks. We'll also explain how Rust closures work and why they're faster than you might expect.

## Capturing Variables

A closure can use data that belongs to an enclosing function. For example:

```
/// Sort by any of several different statistics.
fn sort_by_statistic(cities: &mut Vec<City>, stat: Statistic) {
    cities.sort_by_key(|city| -city.get_statistic(stat));
}
```

The closure here uses `stat`, which is owned by the enclosing function, `sort_by_statistic`. We say that the closure “captures” `stat`. This is one of the classic features of closures, so naturally, Rust supports it; but in Rust, this feature comes with a string attached.

In most languages with closures, garbage collection plays an important role. For example, consider this JavaScript code:

```
// Start an animation that rearranges the rows in a table of cities.
function startSortingAnimation(cities, stat) {
    // Helper function that we'll use to sort the table.
    // Note that this function refers to stat.
    function keyfn(city) {
        return city.get_statistic(stat);
    }

    if (pendingSort)
        pendingSort.cancel();

    // Now kick off an animation, passing keyfn to it.
    // The sorting algorithm will call keyfn later.
    pendingSort = new SortingAnimation(cities, keyfn);
}
```

The closure `keyfn` is stored in the new `SortingAnimation` object. It’s meant to be called after `startSortingAnimation` returns. Now, normally when a function returns, all its variables and arguments go out of scope and are discarded. But here, the JavaScript engine must keep `stat` around somehow, since the closure uses it. Most JavaScript engines do this by allocating `stat` in the heap and letting the garbage collector reclaim it later.

Rust doesn’t have garbage collection. How will this work? To answer this question, we’ll look at two examples.

## Closures That Borrow

First, let's repeat the opening example of this section:

```
fn sort_by_statistic(cities: &mut Vec<City>, stat: Statistic) {
    cities.sort_by_key(|city| -city.get_statistic(stat));
}
```

In this case, when Rust creates the closure, it automatically borrows a reference to `stat`. It stands to reason: the closure refers to `stat`, so it must have a reference to it.

The rest is simple. The closure is subject to the rules about borrowing and lifetimes that we described in [Chapter 5](#). In particular, since the closure contains a reference to `stat`, Rust won't let it outlive `stat`. Since the closure is only used during sorting, this example is fine.

In short, Rust ensures safety by using lifetimes instead of garbage collection. Rust's way is faster: even a fast GC allocation will be slower than storing `stat` on the stack, as Rust does in this case.

## Closures That Steal

The second example is trickier:

```
use std::thread;

fn start_sorting_thread(mut cities: Vec<City>, stat: Statistic)
    -> thread::JoinHandle<Vec<City>>
{
    let key_fn = |city: &City| -> i64 { -city.get_statistic(stat) };

    thread::spawn(|| {
        cities.sort_by_key(key_fn);
        cities
    })
}
```

This is a bit more like what our JavaScript example was doing: `thread::spawn` takes a closure and calls it in a new system thread. Note that `||` is the closure's empty argument list.

The new thread runs in parallel with the caller. When the closure returns, the new thread exits. (The closure's return value is sent back to the calling thread as a `JoinHandle` value. We'll cover that in [Chapter 19](#).)

Again, the closure `key_fn` contains a reference to `stat`. But this time, Rust can't guarantee that the reference is used safely. Rust therefore rejects this program:

```
error[E0373]: closure may outlive the current function, but it borrows `stat`,
             which is owned by the current function
```





Rust to clone `cities` and store the copy in a different variable. The closure would only steal one of the copies—whichever one it refers to.

We get something important by accepting Rust's strict rules: thread safety. It is precisely because the vector is moved, rather than being shared across threads, that we know the old thread won't free the vector while the new thread is modifying it.

## Function and Closure Types

Throughout this chapter, we've seen functions and closures used as values. Naturally, this means that they have types. For example:

```
fn city_population_descending(city: &City) -> i64 {  
    -city.population  
}
```

This function takes one argument (a `&City`) and returns an `i64`. It has the type `fn(&City) -> i64`.

You can do all the same things with functions that you do with other values. You can store them in variables. You can use all the usual Rust syntax to compute function values:

```
let my_key_fn: fn(&City) -> i64 =  
    if user.prefs.by_population {  
        city_population_descending  
    } else {  
        city_monster_attack_risk_descending  
    };  
  
cities.sort_by_key(my_key_fn);
```

Structs may have function-typed fields. Generic types like `Vec` can store scads of functions, as long as they all share the same `fn` type. And function values are tiny: a `fn` value is the memory address of the function's machine code, just like a function pointer in C++.

A function can take another function as an argument. For example:

```
/// Given a list of cities and a test function,  
/// return how many cities pass the test.  
fn count_selected_cities(cities: &Vec<City>,  
    test_fn: fn(&City) -> bool) -> usize  
{  
    let mut count = 0;  
    for city in cities {  
        if test_fn(city) {  
            count += 1;  
        }  
    }  
}
```

```

    count
}

/// An example of a test function. Note that the type of
/// this function is `fn(&City) -> bool`, the same as
/// the `test_fn` argument to `count_selected_cities`.
fn has_monster_attacks(city: &City) -> bool {
    city.monster_attack_risk > 0.0
}

// How many cities are at risk for monster attack?
let n = count_selected_cities(&my_cities, has_monster_attacks);

```

If you're familiar with function pointers in C/C++, you'll see that Rust's function values are exactly the same thing.

After all this, it may come as a surprise that closures do *not* have the same type as functions:

```

let limit = preferences.acceptable_monster_risk();
let n = count_selected_cities(
    &my_cities,
    |city| city.monster_attack_risk > limit); // error: type mismatch

```

The second argument causes a type error. To support closures, we must change the type signature of this function. It needs to look like this:

```

fn count_selected_cities<F>(cities: &Vec<City>, test_fn: F) -> usize
    where F: Fn(&City) -> bool
{
    let mut count = 0;
    for city in cities {
        if test_fn(city) {
            count += 1;
        }
    }
    count
}

```

We have changed only the type signature of `count_selected_cities`, not the body. The new version is generic. It takes a `test_fn` of any type `F` as long as `F` implements the special trait `Fn(&City) -> bool`. This trait is automatically implemented by all functions and closures that take a single `&City` as an argument and return a Boolean value.

```

fn(&City) -> bool    // fn type (functions only)
Fn(&City) -> bool   // Fn trait (both functions and closures)

```

This special syntax is built into the language. The `->` and return type are optional; if omitted, the return type is `()`.

The new version of `count_selected_cities` accepts either a function or a closure:

```

count_selected_cities(
    &my_cities,
    has_monster_attacks); // ok

count_selected_cities(
    &my_cities,
    |city| city.monster_attack_risk > limit); // also ok

```

Why didn't our first attempt work? Well, a closure is callable, but it's not a fn. The closure `|city| city.monster_attack_risk > limit` has its own type that's not a fn type.

In fact, every closure you write has its own type, because a closure may contain data: values either borrowed or stolen from enclosing scopes. This could be any number of variables, in any combination of types. So every closure has an ad hoc type created by the compiler, large enough to hold that data. No two closures have exactly the same type. But every closure implements a Fn trait; the closure in our example implements `Fn(&City) -> i64`.

Since every closure has its own type, code that works with closures usually needs to be generic, like `count_selected_cities`. It's a little clunky to spell out the generic types each time, but to see the advantages of this design, just read on.

## Closure Performance

Rust's closures are designed to be fast: faster than function pointers, fast enough that you can use them even in red-hot, performance-sensitive code. If you're familiar with C++ lambdas, you'll find that Rust closures are just as fast and compact, but safer.

In most languages, closures are allocated in the heap, dynamically dispatched, and garbage collected. So creating them, calling them, and collecting them each cost a tiny bit of extra CPU time. Worse, closures tend to rule out *inlining*, a key technique compilers use to eliminate function call overhead and enable a raft of other optimizations. All told, closures are slow enough in these languages that it can be worth manually removing them from tight inner loops.

Rust closures have none of these performance drawbacks. They're not garbage collected. Like everything else in Rust, they aren't allocated on the heap unless you put them in a `Box`, `Vec`, or other container. And since each closure has a distinct type, whenever the Rust compiler knows the type of the closure you're calling, it can inline the code for that particular closure. This makes it OK to use closures in tight loops, and Rust programs often do so, enthusiastically, as you'll see in [Chapter 15](#).

[Figure 14-1](#) shows how Rust closures are laid out in memory. At the top of the figure, we show a couple of local variables that our closures will refer to: a string `food` and a simple enum `weather`, whose numeric value happens to be 27.

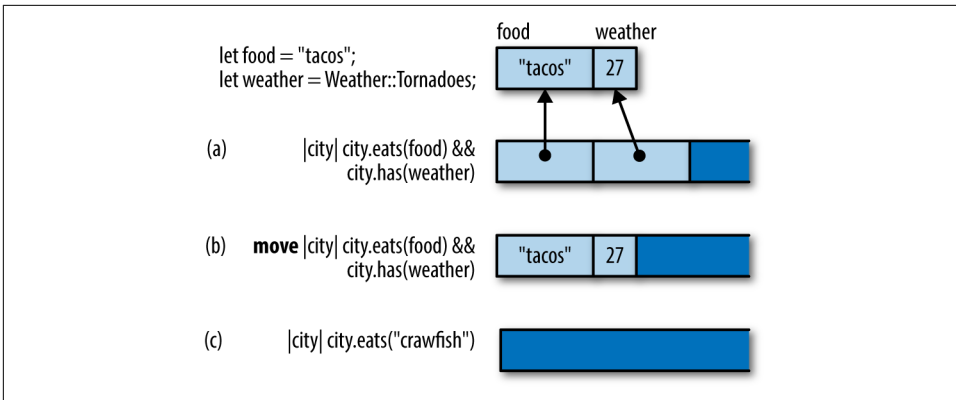

Figure 14-1. Layout of closures in memory

Closure (a) uses both variables. Apparently we’re looking for cities that have both tacos and tornadoes. In memory, this closure looks like a small struct containing references to the variables it uses.

Note that it doesn’t contain a pointer to its code! That’s not necessary: as long as Rust knows the closure’s type, it knows which code to run when you call it.

Closure (b) is exactly the same, except it’s a `move` closure, so it contains values instead of references.

Closure (c) doesn’t use any variables from its environment. The struct is empty, so this closure does not take up any memory at all.

As the figure shows, these closures don’t take up much space. But even those few bytes are not always needed in practice. Often, the compiler can inline all calls to a closure, and then even the small structs shown in this figure are optimized away.

In [“Callbacks” on page 316](#), we’ll show how to allocate closures in the heap and call them dynamically, using trait objects. That is a bit slower, but it is still as fast as any other trait object method.

## Closures and Safety

The next few pages complete our explanation of how closures interact with Rust’s safety system. As we said earlier in this chapter, most of the story is simply that when a closure is created, it either moves or borrows the captured variables. But some of the consequences are not exactly obvious. In particular, we’ll be talking about what happens when a closure drops or modifies a captured value.

## Closures That Kill

We have seen closures that borrow values and closures that steal them; it was only a matter of time before they went all the way bad.

Of course, *kill* is not really the right terminology. In Rust, we *drop* values. The most straightforward way to do it is to call `drop()`:

```
let my_str = "hello".to_string();
let f = || drop(my_str);
```

When `f` is called, `my_str` is dropped.

So what happens if we call it twice?

```
f();
f();
```

Let's think it through. The first time we call `f`, it drops `my_str`, which means the memory where the string is stored is freed, returned to the system. The second time we call `f`, the same thing happens. It's a *double free*, a classic mistake in C++ programming that triggers undefined behavior.

Dropping a `String` twice would be an equally bad idea in Rust. Fortunately, Rust can't be fooled so easily:

```
f(); // ok
f(); // error: use of moved value
```

Rust knows this closure can't be called twice.

A closure that can only be called once may seem like a rather extraordinary thing. But we've been talking throughout this book about ownership and lifetimes. The idea of values being used up (that is, moved) is one of the core concepts in Rust. It works the same with closures as with everything else.

## FnOnce

Let's try once more to trick Rust into dropping a `String` twice. This time, we'll use this generic function:

```
fn call_twice<F>(closure: F) where F: Fn() {
    closure();
    closure();
}
```

This generic function may be passed any closure that implements the trait `Fn()`: that is, closures that take no arguments and return `()`. (As with functions, the return type can be omitted if it's `()`; `Fn()` is shorthand for `Fn() -> ()`.)

Now what happens if we pass our unsafe closure to this generic function?

```
let my_str = "hello".to_string();
let f = || drop(my_str);
call_twice(f);
```

Again, the closure will drop `my_str` when it's called. Calling it twice would be a double free. But again, Rust is not fooled:

```
error[E0525]: expected a closure that implements the `Fn` trait, but
             this closure only implements `FnOnce`
  --> closures_twice.rs:12:13
   |
12 |     let f = || drop(my_str);
   |                ^^^^^^^^^^^^^^^^^^^
   |
note: the requirement to implement `Fn` derives from here
  --> closures_twice.rs:13:5
   |
13 |     call_twice(f);
   |     ^^^^^^^^^^^
```

This error message tells us more about how Rust handles “closures that kill.” They could have been banned from the language entirely, but cleanup closures are useful sometimes. So instead, Rust restricts their use. Closures that drop values, like `f`, are not allowed to have `Fn`. They are, quite literally, no `Fn` at all. They implement a less powerful trait, `FnOnce`, the trait of closures that can be called once.

The first time you call a `FnOnce` closure, *the closure itself is used up*. It's as though the two traits, `Fn` and `FnOnce`, were defined like this:

```
// Pseudocode for `Fn` and `FnOnce` traits with no arguments.
trait Fn() -> R {
    fn call(&self) -> R;
}

trait FnOnce() -> R {
    fn call_once(self) -> R;
}
```

Just as an arithmetic expression like `a + b` is shorthand for a method call, `Add::add(a, b)`, Rust treats `closure()` as shorthand for one of the two trait methods shown above. For a `Fn` closure, `closure()` expands to `closure.call()`. This method takes `self` by reference, so the closure is not moved. But if the closure is only safe to call once, then `closure()` expands to `closure.call_once()`. That method takes `self` by value, so the closure is used up.

Of course we've been deliberately stirring up trouble here by using `drop()`. In practice, you'll mostly get into this situation by accident. It doesn't happen often, but once in a great while you'll write some closure code that unintentionally uses up a value:

```
let dict = produce_glossary();
let debug_dump_dict = || {
```

```

    for (key, value) in dict { // oops!
        println!("{:?} - {:?}", key, value);
    }
};

```

Then, when you call `debug_dump_dict()` more than once, you'll get an error message like this:

```

error[E0382]: use of moved value: `debug_dump_dict`
--> closures_debug_dump_dict.rs:18:5
|
|   debug_dump_dict();
|   ----- value moved here
18 |   debug_dump_dict();
|   ^^^^^^^^^^^^^^^^^ value used here after move
|
= help: closure was moved because it only implements `FnOnce`

```

To debug this, we have to figure out why the closure is a `FnOnce`. Which value is being used up here? The only one we're referring to at all is `dict`. Ah, there's the bug: we're using up `dict` by iterating over it directly. We should be looping over `&dict` rather than plain `dict`, to access the values by reference:

```

let debug_dump_dict = || {
    for (key, value) in &dict { // does not use up dict
        println!("{:?} - {:?}", key, value);
    }
};

```

This fixes the error; the function is now a `Fn` and can be called any number of times.

## FnMut

There is one more kind of closure, the kind that contains mutable data or `mut` references.

Rust considers non-`mut` values safe to share across threads. But it wouldn't be safe to share non-`mut` closures that contain `mut` data: calling such a closure from multiple threads could lead to all sorts of race conditions as multiple threads try to read and write the same data at the same time.

Therefore, Rust has one more category of closure, `FnMut`, the category of closures that write. `FnMut` closures are called by `mut` reference, as if they were defined like this:

```

// Pseudocode for `Fn`, `FnMut`, and `FnOnce` traits.
trait Fn() -> R {
    fn call(&self) -> R;
}

trait FnMut() -> R {
    fn call_mut(&mut self) -> R;
}

```



```

}

trait FnOnce() -> R {
    fn call_once(self) -> R;
}

```

Any closure that requires `mut` access to a value, but doesn't drop any values, is a `FnMut` closure. For example:

```

let mut i = 0;
let incr = || {
    i += 1; // incr borrows a mut reference to i
    println!("Ding! i is now: {}", i);
};
call_twice(incr);

```

The way we wrote `call_twice`, it requires a `Fn`. Since `incr` is a `FnMut` and not a `Fn`, this code fails to compile. There's an easy fix, though. To understand the fix, let's take a step back and summarize what you've learned about the three categories of Rust closures.

- `Fn` is the family of closures and functions that you can call multiple times without restriction. This highest category also includes all `fn` functions.
- `FnMut` is the family of closures that can be called multiple times if the closure itself is declared `mut`.
- `FnOnce` is the family of closures that can be called once, if the caller owns the closure.

Every `Fn` meets the requirements for `FnMut`, and every `FnMut` meets the requirements for `FnOnce`. As shown in [Figure 14-2](#), they're not three separate categories.

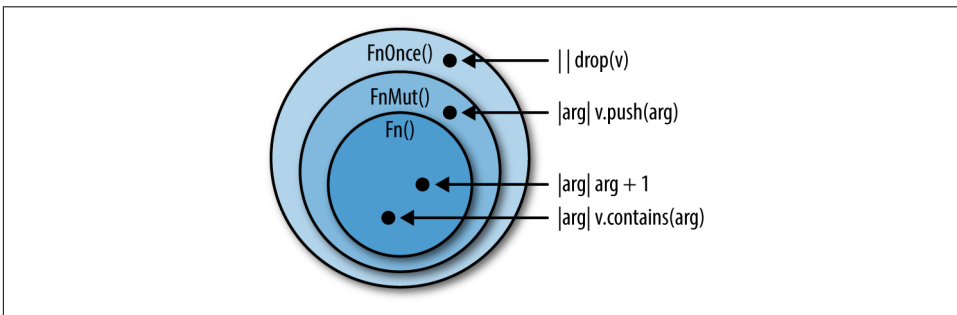

Figure 14-2. Venn diagram of the three closure categories

Instead, `Fn()` is a subtrait of `FnMut()`, which is a subtrait of `FnOnce()`. This makes `Fn` the most exclusive and most powerful category. `FnMut` and `FnOnce` are broader categories that include closures with usage restrictions.

Now that we've organized what we know, it's clear that to accept the widest possible swath of closures, our `call_twice` function really ought to accept all `FnMut` closures, like this:

```
fn call_twice<F>(mut closure: F) where F: FnMut() {
    closure();
    closure();
}
```

The bound on the first line was `F: Fn()`, and now it's `F: FnMut()`. With this change, we still accept all `Fn` closures, and we additionally can use `call_twice` on closures that mutate data:

```
let mut i = 0;
call_twice(|| i += 1); // ok!
assert_eq!(i, 2);
```

## Callbacks

A lot of libraries use *callbacks* as part of their API: functions provided by the user, for the library to call later. In fact, you've seen some APIs like that already in this book. Back in [Chapter 2](#), we used the Iron framework to write a simple web server. It looked like this:

```
fn main() {
    let mut router = Router::new();

    router.get("/", get_form, "root");
    router.post("/gcd", post_gcd, "gcd");

    println!("Serving on http://localhost:3000...");
    Iron::new(router).http("localhost:3000").unwrap();
}
```

The purpose of the router is to route incoming requests from the Internet to the bit of Rust code that handles that particular kind of request. In this example, `get_form` and `post_gcd` were the names of some functions that we declared elsewhere in the program, using the `fn` keyword. But we could have passed closures instead, like this:

```
let mut router = Router::new();

router.get("/", |_: &mut Request| {
    Ok(get_form_response())
}, "root");
router.post("/gcd", |request: &mut Request| {
    let numbers = get_numbers(request)?;
    Ok(get_gcd_response(numbers))
}, "gcd");
```

This is because Iron was written to accept any thread-safe `Fn` as an argument.

How can we do that in our own programs? Let's try writing our own very simple router from scratch, without using any code from Iron. We can begin by declaring a few types to represent HTTP requests and responses:

```
struct Request {
    method: String,
    url: String,
    headers: HashMap<String, String>,
    body: Vec<u8>
}

struct Response {
    code: u32,
    headers: HashMap<String, String>,
    body: Vec<u8>
}
```

Now the job of a router is simply to store a table that maps URLs to callbacks, so that the right callback can be called on demand. (For simplicity's sake, we'll only allow users to create routes that match a single exact URL.)

```
struct BasicRouter<C> where C: Fn(&Request) -> Response {
    routes: HashMap<String, C>
}

impl<C> BasicRouter<C> where C: Fn(&Request) -> Response {
    /// Create an empty router.
    fn new() -> BasicRouter<C> {
        BasicRouter { routes: HashMap::new() }
    }

    /// Add a route to the router.
    fn add_route(&mut self, url: &str, callback: C) {
        self.routes.insert(url.to_string(), callback);
    }
}
```

Unfortunately, we've made a mistake. Did you notice it?

This router works fine as long as we only add one route to it:

```
let mut router = BasicRouter::new();
router.add_route("/", |_| get_form_response());
```

This much compiles and runs. Unfortunately, if we add another route:

```
router.add_route("/gcd", |req| get_gcd_response(req));
```

then we get errors:

```
error[E0308]: mismatched types
  --> closures_bad_router.rs:41:30
   |
41 |     router.add_route("/gcd", |req| get_gcd_response(req));
```

```

|                                                     ^^^^^^^^^^^^^^^^^^^^^^^^^^^^^^^^^^^^^
|                                                     expected closure, found a different closure
|
= note: expected type `[closure@closures_bad_router.rs:40:27: 40:50]`
      found type `[closure@closures_bad_router.rs:41:30: 41:57]`
note: no two closures, even if identical, have the same type
help: consider boxing your closure and/or using it as a trait object

```

Our mistake was in how we defined the `BasicRouter` type:

```

struct BasicRouter<C> where C: Fn(&Request) -> Response {
    routes: HashMap<String, C>
}

```

We unwittingly declared that each `BasicRouter` has a single callback type `C`, and all the callbacks in the `HashMap` are of that type. Back in [“Which to Use” on page 243](#), we showed a `Salad` type that had the same problem.

```

struct Salad<V: Vegetable> {
    veggies: Vec<V>
}

```

The solution here is the same as for the salad: since we want to support a variety of types, we need to use boxes and trait objects.

```

type BoxedCallback = Box<Fn(&Request) -> Response>;

struct BasicRouter {
    routes: HashMap<String, BoxedCallback>
}

```

Each box can contain a different type of closure, so a single `HashMap` can contain all sorts of callbacks. Note that the type parameter `C` is gone.

This requires a few adjustments to the methods:

```

impl BasicRouter {
    // Create an empty router.
    fn new() -> BasicRouter {
        BasicRouter { routes: HashMap::new() }
    }

    // Add a route to the router.
    fn add_route<C>(&mut self, url: &str, callback: C)
        where C: Fn(&Request) -> Response + 'static
    {
        self.routes.insert(url.to_string(), Box::new(callback));
    }
}

```

(Note the two bounds on `C` in the type signature for `add_route`: a particular `Fn` trait, and the `'static` lifetime. Rust makes us add this `'static` bound. Without it, the call

to `Box::new(callback)` would be an error, because it's not safe to store a closure if it contains borrowed references to variables that are about to go out of scope.)

Finally, our simple router is ready to handle incoming requests:

```
impl BasicRouter {  
    fn handle_request(&self, request: &Request) -> Response {  
        match self.routes.get(&request.url) {  
            None => not_found_response(),  
            Some(callback) => callback(request)  
        }  
    }  
}
```

## Using Closures Effectively

As we've seen, Rust's closures are different from closures in most other languages. The biggest difference is that in languages with GC, you can use local variables in a closure without having to think about lifetimes or ownership. Without GC, things are different. Some design patterns that are commonplace in Java, C#, and JavaScript won't work in Rust without changes.

For example, take the Model-View-Controller design pattern (MVC for short), illustrated in [Figure 14-3](#). For every element of a user interface, an MVC framework creates three objects: a *model* representing that UI element's state, a *view* that's responsible for its appearance, and a *controller* that handles user interaction. Countless variations on MVC have been implemented over the years, but the general idea is that three objects divvy up the UI responsibilities somehow.

Here's the problem. Typically, each object has a reference to one or both of the others, directly or through a callback, as shown in [Figure 14-3](#). Whenever anything happens to one of the objects, it notifies the others, so everything updates promptly. The question of which object "owns" the others never comes up.

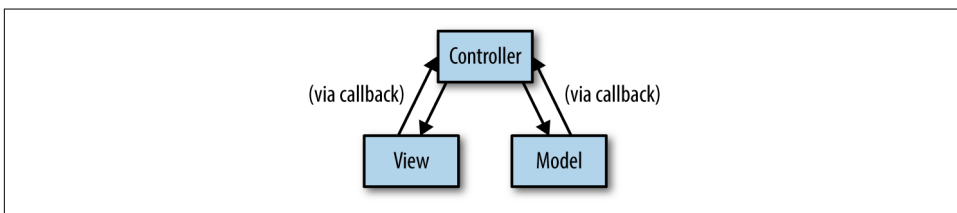

*Figure 14-3. The Model-View-Controller design pattern*

You can't implement this pattern in Rust without making some changes. Ownership must be made explicit, and reference cycles must be eliminated. The model and the controller can't have direct references to each other.

Rust’s radical wager is that good alternative designs exist. Sometimes you can fix a problem with closure ownership and lifetimes by having each closure receive the references it needs as arguments. Sometimes you can assign each thing in the system a number and pass around the numbers instead of references. Or you can implement one of the many variations on MVC where the objects don’t all have references to each other. Or model your toolkit after a non-MVC system with unidirectional data flow, like Facebook’s Flux architecture, shown in [Figure 14-4](#).

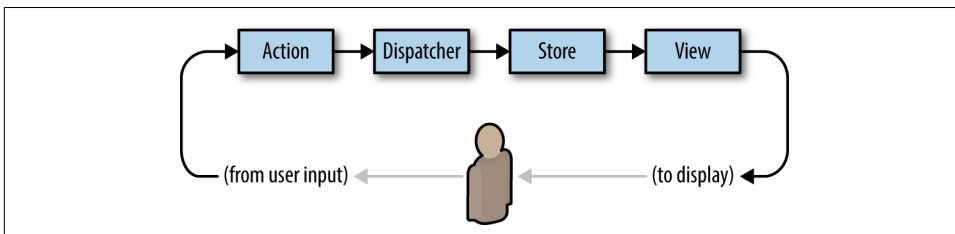

Figure 14-4. The Flux architecture, an alternative to MVC

In short, if you try to use Rust closures to make a “sea of objects,” you’re going to have a hard time. But there are alternatives. In this case, it seems software engineering as a discipline is already gravitating to the alternatives anyway, because they’re simpler.

In the next chapter, we turn to a topic where closures really shine. We’ll be writing a kind of code that takes full advantage of the concision, speed, and efficiency of Rust closures and that’s fun to write, easy to read, and eminently practical. Up next: Rust iterators.

*It was the end of a very long day.*

— Phil

An *iterator* is a value that produces a sequence of values, typically for a loop to operate on. Rust's standard library provides iterators that traverse vectors, strings, hash tables, and other collections, but also iterators to produce lines of text from an input stream, connections arriving at a network server, values received from other threads over a communications channel, and so on. And of course, you can implement iterators for your own purposes. Rust's for loop provides a natural syntax for using iterators, but iterators themselves also provide a rich set of methods for mapping, filtering, joining, collecting, and so on.

Rust's iterators are flexible, expressive, and efficient. Consider the following function, which returns the sum of the first *n* positive integers (often called the *n*th triangle number):

```
fn triangle(n: i32) -> i32 {
    let mut sum = 0;
    for i in 1..n+1 {
        sum += i;
    }
    sum
}
```

The expression `1..n+1` is a `Range<i32>` value. A `Range<i32>` is an iterator that produces the integers from its start value (inclusive) to its end value (exclusive), so you can use it as the operand of the for loop to sum the values from 1 to *n*.

But iterators also have a `fold` method, which you can use in the equivalent definition:

```
fn triangle(n: i32) -> i32 {
    (1..n+1).fold(0, |sum, item| sum + item)
}
```

Starting with 0 as the running total, `fold` takes each value that `1..n+1` produces and applies the closure `|sum, item| sum + item` to the running total and the value. The closure's return value is taken as the new running total. The last value it returns is what `fold` itself returns—in this case, the total of the entire sequence. This may look strange if you're used to `for` and `while` loops, but once you've gotten used to it, `fold` is a legible and concise alternative.

This is pretty standard fare for functional programming languages, which put a premium on expressiveness. But Rust's iterators were carefully designed to ensure that the compiler can translate them into excellent machine code as well. In a release build of the second definition shown before, Rust knows the definition of `fold`, and inlines it into `triangle`. Next, the closure `|sum, item| sum + item` is inlined into that. Finally, Rust examines the combined code and recognizes that there's a simpler way to sum the numbers from one to `n`: the sum is always equal to  $n * (n+1) / 2$ . Rust translates the entire body of `triangle`, loop, closure, and all, into a single multiplication instruction and a few other bits of arithmetic.

This example happens to involve simple arithmetic, but iterators also perform well when put to heavier use. They're another example of Rust providing flexible abstractions that impose little or no overhead in typical use.

The rest of this chapter falls into five parts:

- First we'll explain the `Iterator` and `IntoIterator` traits, which are the foundation of Rust's iterators.
- Then we'll go over the three stages of a typical iterator pipeline: creating an iterator from some sort of value source; adapting one sort of iterator into another by selecting or processing values as they go by; and then consuming the values the iterator produces.
- Finally, we'll show how to implement iterators for your own types.

There are a lot of methods, so it's fine to skim a section once you've got the general idea. But iterators are very common in idiomatic Rust, and being familiar with the tools that come with them is essential to mastering the language.

## The Iterator and IntoIterator Traits

An iterator is any value that implements the `std::iter::Iterator` trait:



```

trait Iterator {
    type Item;
    fn next(&mut self) -> Option<Self::Item>;
    ... // many default methods
}

```

Item is the type of value the iterator produces. The next method either returns Some(v), where v is the iterator's next value, or returns None to indicate the end of the sequence. Here we've omitted Iterator's many default methods; we'll cover them individually throughout the rest of this chapter.

If there's a natural way to iterate over some type, it can implement std::iter::IntoIterator, whose into\_iter method takes a value and returns an iterator over it:

```

trait IntoIterator where Self::IntoIter::Item == Self::Item {
    type Item;
    type IntoIter: Iterator;
    fn into_iter(self) -> Self::IntoIter;
}

```

IntoIter is the type of the iterator value itself, and Item is the type of value it produces. We call any type that implements IntoIterator an *iterable*, because it's something you could iterate over if you asked.

Rust's for loop brings all these parts together nicely. To iterate over a vector's elements, you can write:

```

println!("There's:");
let v = vec!["antimony", "arsenic", "aluminum", "selenium"];

for element in &v {
    println!("{}", element);
}

```

Under the hood, every for loop is just shorthand for calls to IntoIterator and Iterator methods:

```

let mut iterator = (&v).into_iter();
while let Some(element) = iterator.next() {
    println!("{}", element);
}

```

The for loop uses IntoIterator::into\_iter to convert its operand &v into an iterator, and then calls Iterator::next repeatedly. Each time that returns Some(element), the for loop executes its body; and if it returns None, the loop finishes.

Although a for loop always calls into\_iter on its operand, you can also pass iterators to for loops directly; this occurs when you loop over a Range, for example. All

iterators automatically implement `IntoIterator`, with an `into_iter` method that simply returns the iterator.

If you call an iterator's `next` method again after it has returned `None`, the `Iterator` trait doesn't specify what it should do. Most iterators will just return `None` again, but not all. (If this causes problems, the fuse adaptor covered in “fuse” on page 338 can help.)

Here's some terminology for iterators:

- As we've said, an *iterator* is any type that implements `Iterator`.
- An *iterable* is any type that implements `IntoIterator`: you can get an iterator over it by calling its `into_iter` method. The vector reference `&v` is the iterable in this case.
- An iterator *produces* values.
- The values an iterator produces are *items*. Here, the items are "antimony", "arsenic", and so on.
- The code that receives the items an iterator produces is the *consumer*. In this example, the for loop consumes the iterator's items.

## Creating Iterators

The Rust standard library documentation explains in detail what sort of iterators each type provides, but the library follows some general conventions to help you get oriented and find what you need.

### `iter` and `iter_mut` Methods

Most collection types provide `iter` and `iter_mut` methods that return the natural iterators over the type, producing a shared or mutable reference to each item. Slices like `&[T]` and `&str` have `iter` and `iter_mut` methods too. These methods are the most common way to get an iterator, if you're not going to let a for loop take care of it for you:

```
let v = vec![4, 20, 12, 8, 6];
let mut iterator = v.iter();
assert_eq!(iterator.next(), Some(&4));
assert_eq!(iterator.next(), Some(&20));
assert_eq!(iterator.next(), Some(&12));
assert_eq!(iterator.next(), Some(&8));
assert_eq!(iterator.next(), Some(&6));
assert_eq!(iterator.next(), None);
```

This iterator's item type is `&i32`: each call to `next` produces a reference to the next element, until we reach the end of the vector.

Each type is free to implement `iter` and `iter_mut` in whatever way makes the most sense for its purpose. The `iter` method on `std::path::Path` returns an iterator that produces one path component at a time:

```
use std::ffi::OsStr;
use std::path::Path;

let path = Path::new("C:/Users/JimB/Downloads/Fedora.iso");
let mut iterator = path.iter();
assert_eq!(iterator.next(), Some(OsStr::new("C:")));
assert_eq!(iterator.next(), Some(OsStr::new("Users")));
assert_eq!(iterator.next(), Some(OsStr::new("JimB")));
...

```

This iterator's item type is `&std::ffi::OsStr`, a borrowed slice of a string of the sort accepted by operating system calls.

## IntoIterator Implementations

When a type implements `IntoIterator`, you can call its `into_iter` method yourself, just as a `for` loop would:

```
// You should usually use HashSet, but its iteration order is
// nondeterministic, so BTreeSet works better in examples.
use std::collections::BTreeSet;
let mut favorites = BTreeSet::new();
favorites.insert("Lucy in the Sky With Diamonds".to_string());
favorites.insert("Liebesträume No. 3".to_string());

let mut it = favorites.into_iter();
assert_eq!(it.next(), Some("Liebesträume No. 3".to_string()));
assert_eq!(it.next(), Some("Lucy in the Sky With Diamonds".to_string()));
assert_eq!(it.next(), None);

```

Most collections actually provide several implementations of `IntoIterator`, for shared references, mutable references, and moves:

- Given a *shared reference* to the collection, `into_iter` returns an iterator that produces shared references to its items. For example, in the preceding code, `(&favorites).into_iter()` would return an iterator whose `Item` type is `&String`.
- Given a *mutable reference* to the collection, `into_iter` returns an iterator that produces mutable references to the items. For example, if `vector` is some `Vec<String>`, the call `(&mut vector).into_iter()` returns an iterator whose `Item` type is `&mut String`.

- When passed the collection *by value*, `into_iter` returns an iterator that takes ownership of the collection and returns items by value; the items' ownership moves from the collection to the consumer, and the original collection is consumed in the process. For example, the call `favorites.into_iter()` in the preceding code returns an iterator that produces each string by value; the consumer receives ownership of each string. When the iterator is dropped, any elements remaining in the `BTreeSet` are dropped too, and the set's now-empty husk is disposed of.

Since a `for` loop applies `IntoIterator::into_iter` to its operand, these three implementations are what create the following idioms for iterating over shared or mutable references to a collection, or consuming the collection and taking ownership of its elements:

```
for element in &collection { ... }
for element in &mut collection { ... }
for element in collection { ... }
```

Each of these simply results in a call to one of the `IntoIterator` implementations listed here.

Not every type provides all three implementations. For example, `HashSet`, `BTreeSet` and `BinaryHeap` don't implement `IntoIterator` on mutable references, since modifying their elements would probably violate the type's invariants: the modified value might have a different hash value, or be ordered differently with respect to its neighbors, so modifying it would leave it incorrectly placed. Other types do support mutation, but only partially. For example, `HashMap` and `BTreeMap` produce mutable reference to their entries' values, but only shared references to their keys, for similar reasons to those given earlier.

The general principle is that iteration should be efficient and predictable, so rather than providing implementations that are expensive or could exhibit surprising behavior (for example, rehashing modified `HashSet` entries, and potentially revisiting them later in the iteration), Rust omits them entirely.

Slices implement two of the three `IntoIterator` variants; since they don't own their elements, there is no "by value" case. Instead, `into_iter` for `&[T]` and `&mut [T]` returns an iterator that produces shared and mutable references to the elements. If you imagine the underlying slice type `[T]` as a collection of some sort, this fits neatly into the overall pattern.

You may have noticed that the first two `IntoIterator` variants, for shared and mutable references, are equivalent to calling `iter` or `iter_mut` on the referent. Why does Rust provide both?

`IntoIterator` is what makes for loops work, so that's obviously necessary. But when you're not using a for loop, `favorites.iter()` is clearer than `(&favorites).into_iter()`. Iteration by shared reference is something you'll need frequently, so `iter` and `iter_mut` are still valuable for their ergonomics.

`IntoIterator` can also be useful in generic code: you can use a bound like `T: IntoIterator` to restrict the type variable `T` to types that can be iterated over. Or, you can write `T: IntoIterator<Item=U>` to further require the iteration to produce a particular type `U`. For example, this function dumps values from any iterable whose items are printable with the "{:?}", format:

```
use std::fmt::Debug;

fn dump<T, U>(t: T)
  where T: IntoIterator<Item=U>,
        U: Debug
{
  for u in t {
    println!("{:?}", u);
  }
}
```

You can't write this generic function using `iter` and `iter_mut`, since they're not methods of any trait: most iterable types just happen to have methods by those names.

## drain Methods

Many collection types provide a `drain` method that takes a mutable reference to the collection and returns an iterator that passes ownership of each element to the consumer. However, unlike the `into_iter()` method, which takes the collection by value and consumes it, `drain` merely borrows a mutable reference to the collection, and when the iterator is dropped, it removes any remaining elements from the collection, and leaves it empty.

On types that can be indexed by a range, like `Strings`, `vectors`, and `VecDeque`s, the `drain` method takes a range of elements to remove, rather than draining the entire sequence:

```
use std::iter::FromIterator;

let mut outer = "Earth".to_string();
let inner = String::from_iter(outer.drain(1..4));

assert_eq!(outer, "Eh");
assert_eq!(inner, "art");
```

If you do need to drain the entire sequence, use the full range, `..`, as the argument.

## Other Iterator Sources

The previous sections are mostly concerned with collection types like vectors and `HashMap`, but there are many other types in the standard library that support iteration. [Table 15-1](#) summarizes the more interesting ones, but there are many more. We cover some of these methods in more detail in the chapters dedicated to the specific types (namely, [Chapters 16, 17, and 18](#)).

*Table 15-1. Other iterators in the standard library*

Type or trait	Expression	Notes
<code>std::ops::Range</code>	<code>1..10</code>	Endpoints must be an integer type to be iterable. Range includes start value, and excludes end value.
<code>std::ops::RangeFrom</code>	<code>1..</code>	Unbounded iteration. Start must be an integer. May panic or overflow if the value reaches the limit of the type.
<code>Option&lt;T&gt;</code>	<code>Some(10).iter()</code>	Behaves like a vector whose length is either 0 (None) or 1 (Some(v)).
<code>Result&lt;T, E&gt;</code>	<code>Ok("blah").iter()</code>	Similar to <code>Option</code> , producing <code>Ok</code> values.
<code>Vec&lt;T&gt;, &amp;[T]</code>	<code>v.windows(16)</code>	Produces every contiguous slice of the given length, from left to right. The windows overlap.
	<code>v.chunks(16)</code>	Produces nonoverlapping, contiguous slices of the given length, from left to right.
	<code>v.chunks_mut(1024)</code>	Like <code>chunks</code> , but slices are mutable.
	<code>v.split( byte  byte &amp; 1 != 0)</code>	Produces slices separated by elements that match the given predicate.
	<code>v.split_mut(...)</code>	As above, but produces mutable slices.
	<code>v.rsplit(...)</code>	Like <code>split</code> , but produces slices from right to left.
	<code>v.splitn(n, ...)</code>	Like <code>split</code> , but produces at most <code>n</code> slices.

Type or trait	Expression	Notes
String, &str	s.bytes()	Produces the bytes of the UTF-8 form.
	s.chars()	Produces the chars the UTF-8 represents.
	s.split_whitespace()	Splits string by whitespace, and produces slices of nonspace characters.
	s.lines()	Produces slices of the lines of the string.
	s.split('/')	Splits string on a given pattern, producing the slices between matches. Patterns can be many things: characters, strings, closures.
	s.matches(char::is_numeric)	Produces slices matching the given pattern.
std::collections::HashMap, std::collections::BTreeMap	map.keys(), map.values()	Produces shared references to keys or values of the map.
	map.values_mut()	Produces mutable references to entries' values.
std::collections::HashSet, std::collections::BTreeSet	set1.union(set2)	Produces shared references to elements of union of set1 and set2.
	set1.intersection(set2)	Produces shared references to elements of intersection of set1 and set2.
std::sync::mpsc::Receiver	recv.iter()	Produces values sent from another thread on the corresponding Sender.
std::io::Read	stream.bytes()	Produces bytes from an I/O stream.
	stream.chars()	Parses stream as UTF-8 and produces chars.
std::io::BufRead	bufstream.lines()	Parses stream as UTF-8, produces lines as Strings.
	bufstream.split(0)	Splits stream on given byte, produces inter-byte Vec<u8> buffers.

Type or trait	Expression	Notes
<code>std::fs::ReadDir</code>	<code>std::fs::read_dir(path)</code>	Produces directory entries.
<code>std::net::TcpListener</code>	<code>listener.incoming()</code>	Produces incoming network connections.
Free functions	<code>std::iter::empty()</code>	Returns <code>None</code> immediately.
	<code>std::iter::once(5)</code>	Produces the given value, and then ends.
	<code>std::iter::repeat("#9")</code>	Produces the given value forever.

## Iterator Adapters

Once you have an iterator in hand, the `Iterator` trait provides a broad selection of *adapter methods*, or simply *adapters*, that consume one iterator and build a new one with useful behaviors. To see how adapters work, we'll show how to use two of the most popular ones.

### map and filter

The `Iterator` trait's `map` adapter lets you transform an iterator by applying a closure to its items. The `filter` adapter lets you filter out items from an iterator, using a closure to decide which to keep and which to drop.

For example, suppose you're iterating over lines of text, and want to omit leading and trailing whitespace from each line. The standard library's `str::trim` method drops leading and trailing whitespace from a single `&str`, returning a new, trimmed `&str` that borrows from the original. You can use the `map` adapter to apply `str::trim` to each line from the iterator:

```
let text = " ponies \n giraffes\niguanas \nsquid".to_string();
let v: Vec<&str> = text.lines()
    .map(str::trim)
    .collect();
assert_eq!(v, ["ponies", "giraffes", "iguanas", "squid"]);
```

The `text.lines()` call returns an iterator that produces the string's lines. Calling `map` on that iterator returns a second iterator that applies `str::trim` to each line, and produces the results as its items. Finally, `collect` gathers those items into a vector.

The iterator `map` returns is, of course, itself a candidate for further adaptation. If you want to exclude iguanas from the result, you can write the following:

```
let text = " ponies \n giraffes\niguanas \nsquid".to_string();
let v: Vec<&str> = text.lines()
    .map(str::trim)
```



```

        .filter(|s| *s != "iguanas")
        .collect();
    assert_eq!(v, ["ponies", "giraffes", "squid"]);

```

Here, `filter` returns a third iterator that produces only those items from the `map` iterator for which the closure `|s| *s != "iguanas"` returns `true`. A chain of iterator adapters is like a pipeline in the Unix shell: each adapter has a single purpose, and it's clear how the sequence is being transformed as one reads from left to right.

These adapters' signatures are as follows:

```

fn map<B, F>(self, f: F) -> some Iterator<Item=B>
    where Self: Sized, F: FnMut(Self::Item) -> B;

fn filter<P>(self, predicate: P) -> some Iterator<Item=Self::Item>
    where Self: Sized, P: FnMut(&Self::Item) -> bool;

```

The `some Iterator<...>` notation we're using for the return types is not valid Rust.<sup>1</sup> The real return types are opaque `struct` types, which aren't informative; what matters in practice is that these methods return iterators with the given `Item` type.

Since most adapters take `self` by value, they require `Self` to be `Sized` (which all common iterators are).

A `map` iterator passes each item to its closure by value, and in turn, passes along ownership of the closure's result to its consumer. A `filter` iterator passes each item to its closure by shared reference, retaining ownership in case the item is selected to be passed on to its consumer. This is why the example must dereference `s` to compare it with `"iguanas"`: the `filter` iterator's item type is `&str`, so the type of the closure's argument `s` is `&&str`.

There are two important points to notice about iterator adapters.

First, simply calling an adapter on an iterator doesn't consume any items; it just returns a new iterator, ready to produce its own items by drawing from the first iterator as needed. In a chain of adapters, the only way to make any work actually get done is to call `next` on the final iterator.

So in our earlier example, the method call `text.lines()` itself doesn't actually parse any lines from the string; it just returns an iterator that *would* parse lines if asked. Similarly, `map` and `filter` just return new iterators that *would* map or filter if asked. No work takes place until `collect` starts calling `next` on the `filter` iterator.

---

<sup>1</sup> Rust RFC 1522 will add syntax to the language very much like our `some Iterator` notation. As of Rust 1.17, it is not yet included in the language by default.

This point is especially important if you use adapters that have side effects. For example, this code prints nothing at all:

```
["earth", "water", "air", "fire"]
  .iter().map(|elt| println!("{}", elt));
```

The `iter` call returns an iterator over the array's elements, and the `map` call returns a second iterator that applies the closure to each value the first produces. But there is nothing here that ever actually demands a value from the whole chain, so no `next` method ever runs. In fact, Rust will warn you about this:

```
warning: unused result which must be used:
iterator adaptors are lazy and do nothing unless consumed
|
387 | /           ["earth", "water", "air", "fire"]
388 | |           .iter().map(|elt| println!("{}", elt));
    | |_____^
    |
= note: #[warn(unused_must_use)] on by default
```

The term “lazy” in the error message is not a disparaging term; it's just jargon for any mechanism that puts off a computation until its value is needed. It is Rust's convention that iterators should do the minimum work necessary to satisfy each call to `next`; In the example, there are no such calls at all, so no work takes place.

The second important point is that iterator adapters are a zero-overhead abstraction. Since `map`, `filter`, and their companions are generic, applying them to an iterator specializes their code for the specific iterator type involved. This means that Rust has enough information to inline each iterator's `next` method into its consumer, and then translate the entire arrangement into machine code as a unit. So the `lines/map/filter` chain of iterators we showed before is as efficient as the code you would probably write by hand:

```
for line in text.lines() {
    let line = line.trim();
    if line != "iguanas" {
        v.push(line);
    }
}
```

The rest of this section covers the various adapters available on the `Iterator` trait.

## filter\_map and flat\_map

The `map` adapter is fine in situations where each incoming item produces one outgoing item. But what if you want to delete certain items from the iteration instead of processing them, or replace single items with zero or more items? The `filter_map` and `flat_map` adapters grant you this flexibility.

The `filter_map` adapter is similar to `map` except that it lets its closure either transform the item into a new item (as `map` does) or drop the item from the iteration. Thus, it's a bit like a combination of `filter` and `map`. Its signature is as follows:

```
fn filter_map<B, F>(self, f: F) -> some Iterator<Item=B>
    where Self: Sized, F: FnMut(Self::Item) -> Option<B>;
```

This is the same as `map`'s signature, except that here the closure returns `Option<B>`, not simply `B`. When the closure returns `None`, the item is dropped from the iteration; when it returns `Some(b)`, then `b` is the next item the `filter_map` iterator produces.

For example, suppose you want to scan a string for whitespace-separated words that can be parsed as numbers, and process the numbers, dropping the other words. You can write:

```
use std::str::FromStr;

let text = "1\nfrond .25 289\n3.1415 estuary\n";
for number in text.split_whitespace()
    .filter_map(|w| f64::from_str(w).ok()) {
    println!("{:4.2}", number.sqrt());
}
```

This prints the following:

```
1.00
0.50
17.00
1.77
```

The closure given to `filter_map` tries to parse each whitespace-separated slice using `f64::from_str`. That returns a `Result<f64, ParseFloatError>`, which `.ok()` turns into an `Option<f64>`: a parse error becomes `None`, whereas a successful parse result becomes `Some(v)`. The `filter_map` iterator drops all the `None` values, and produces the value `v` for each `Some(v)`.

But what's the point in fusing `map` and `filter` into a single operation like this, instead of just using those adapters directly? The `filter_map` adapter shows its value in situations like the one just shown, when the best way to decide whether to include the item in the iteration is to actually try to process it. You can do the same thing with only `filter` and `map`, but it's a bit ungainly:

```
text.split_whitespace()
    .map(|w| f64::from_str(w))
    .filter(|r| r.is_ok())
    .map(|r| r.unwrap())
```

You can think of the `flat_map` adapter as continuing in the same vein as `map` and `filter_map`, except that now the closure can return not just one item (as with `map`) or

zero or one items (as with `filter_map`), but a sequence of any number of items. The `flat_map` iterator produces the concatenation of the sequences the closure returns.

The signature of `flat_map` is shown here:

```
fn flat_map<U, F>(self, f: F) -> some Iterator<Item=U::Item>
  where F: FnMut(Self::Item) -> U, U: IntoIterator;
```

The closure passed to `flat_map` must return an iterable, but any sort of iterable will do.<sup>2</sup>

For example, suppose we have a table mapping countries to their major cities. Given a list of countries, how can we iterate over their major cities?

```
use std::collections::HashMap;

let mut major_cities = HashMap::new();
major_cities.insert("Japan", vec!["Tokyo", "Kyoto"]);
major_cities.insert("The United States", vec!["Portland", "Nashville"]);
major_cities.insert("Brazil", vec!["São Paulo", "Brasília"]);
major_cities.insert("Kenya", vec!["Nairobi", "Mombasa"]);
major_cities.insert("The Netherlands", vec!["Amsterdam", "Utrecht"]);

let countries = ["Japan", "Brazil", "Kenya"];

for &city in countries.iter().flat_map(|country| &major_cities[country]) {
    println!("{}", city);
}
```

This prints the following:

```
Tokyo
Kyoto
São Paulo
Brasília
Nairobi
Mombasa
```

One way to look at this would be to say that, for each country, we retrieve the vector of its cities, concatenate all the vectors together into a single sequence, and print that.

But remember that iterators are lazy: it's only the `for` loop's calls to the `flat_map` iterator's `next` method that cause work to be done. The full concatenated sequence is never constructed in memory. Instead, what we have here is a little state machine that draws from the city iterator, one item at a time, until it's exhausted, and only then produces a new city iterator for the next country. The effect is that of a nested loop, but packaged up for use as an iterator.

---

<sup>2</sup> In fact, since `Option` is an iterable behaving like a sequence of zero or one items, `iterator.filter_map(closure)` is equivalent to `iterator.flat_map(closure)`, assuming `closure` returns an `Option<T>`.

## scan

The `scan` adapter resembles `map`, except that the closure is given a mutable value it can consult, and has the option of terminating the iteration early. It takes an initial state value, and then a closure that accepts a mutable reference to the state, and the next item from the underlying iterator. The closure must return an `Option`, which the `scan` iterator takes as its next item.

For example, here's an iterator chain that squares another iterator's items, and terminates the iteration once their sum exceeds 10:

```
let iter = (0..10)
    .scan(0, |sum, item| {
        *sum += item;
        if *sum > 10 {
            None
        } else {
            Some(item * item)
        }
    });

assert_eq!(iter.collect::<Vec<i32>>(), vec![0, 1, 4, 9, 16]);
```

The closure's `sum` argument is a mutable reference to a value private to the iterator and initialized to `scan`'s first argument—in this case, `0`. The closure updates `*sum`, checks whether it has exceeded the limit, and returns the iterator's next result.

## take and take\_while

The `Iterator` trait's `take` and `take_while` adapters let you end an iteration after a certain number of items, or when a closure decides to cut things off. Their signatures are as follows:

```
fn take(self, n: usize) -> some Iterator<Item=Self::Item>
    where Self: Sized;

fn take_while<P>(self, predicate: P) -> some Iterator<Item=Self::Item>
    where Self: Sized, P: FnMut(&Self::Item) -> bool;
```

Both `take` ownership of an iterator and return a new iterator that passes along items from the first one, possibly ending the sequence earlier. The `take` iterator returns `None` after producing at most `n` items. The `take_while` iterator applies `predicate` to each item, and returns `None` in place of the first item for which `predicate` returns `false`, and on every subsequent call to `next`.

For example, given an email message with a blank line separating the headers from the message body, you can use `take_while` to iterate over only the headers:

```
let message = "To: jim\b\r\n\
              From: superego <editor@oreilly.com>\r\n\
```

```

        \r\n\
        Did you get any writing done today?\r\n\
        When will you stop wasting time plotting fractals?\r\n";
for header in message.lines().take_while(|l| !l.is_empty()) {
    println!("{}", header);
}

```

Recall from “String Literals” on page 64 that when a line in a string ends with a backslash, Rust doesn’t include the indentation of the next line in the string, so none of the lines in the string have any leading whitespace. This means that the third line of `message` is blank. The `take_while` adapter terminates the iteration as soon as it sees that blank line, so this code prints only the two lines:

```

To: jimb
From: superego <editor@oreilly.com>

```

## skip and skip\_while

The `Iterator` trait’s `skip` and `skip_while` methods are the complement of `take` and `take_while`: they drop a certain number of items from the beginning of an iteration, or drop items until a closure finds one acceptable, and then pass the remaining items through unchanged. Their signatures are as follows:

```

fn skip(self, n: usize) -> some Iterator<Item=Self::Item>
    where Self: Sized;

fn skip_while<P>(self, predicate: P) -> some Iterator<Item=Self::Item>
    where Self: Sized, P: FnMut(&Self::Item) -> bool;

```

One common use for the `skip` adapter is to skip the command name when iterating over a program’s command-line arguments. In Chapter 2, our greatest common denominator calculator used the following code to loop over its command-line arguments:

```

for arg in std::env::args().skip(1) {
    ...
}

```

The `std::env::args` function returns an iterator that produces the program’s arguments as `Strings`, the first item being the name of the program itself. That’s not a string we want to process in this loop. Calling `skip(1)` on that iterator returns a new iterator that drops the program name the first time it’s called, and then produces all the subsequent arguments.

The `skip_while` adapter uses a closure to decide how many items to drop from the beginning of the sequence. You can iterate over the body lines of the message from the previous section like this:

```

for body in message.lines()
    .skip_while(|l| !l.is_empty())

```

```

        .skip(1) {
            println!("{}", body);
        }
    }
}

```

This uses `skip_while` to skip nonblank lines, but that iterator does produce the blank line itself—after all, the closure returned `false` for that line. So we use the `skip` method as well to drop that, giving us an iterator whose first item will be the message body’s first line. Taken together with the declaration of `message` from the previous section, this code prints:

```

Did you get any writing done today?
When will you stop wasting time plotting fractals?

```

## peekable

A peekable iterator lets you peek at the next item that will be produced without actually consuming it. You can turn almost any iterator into a peekable iterator by calling the `Iterator` trait’s `peekable` method:

```

fn peekable(self) -> std::iter::Peekable<Self>
    where Self: Sized;

```

Here, `Peekable<Self>` is a struct that implements `Iterator<Item=Self::Item>`, and `Self` is the type of the underlying iterator.

A `Peekable` iterator has an additional method `peek` that returns an `Option<&Item>`: `None` if the underlying iterator is done, and otherwise `Some(r)`, where `r` is a shared reference to the next item. (Note that, if the iterator’s item type is already a reference to something, this ends up being a reference to a reference.)

Calling `peek` tries to draw the next item from the underlying iterator, and if there is one, caches it until the next call to `next`. All the other `Iterator` methods on `Peekable` know about this cache: for example, `iter.last()` on a peekable iterator `iter` knows to check the cache after exhausting the underlying iterator.

Peekable iterators are essential when you can’t decide how many items to consume from an iterator until you’ve gone too far. For example, if you’re parsing numbers from a stream of characters, you can’t decide where the number ends until you’ve seen the first non-number character following it:

```

use std::iter::Peekable;

fn parse_number<I>(tokens: &mut Peekable<I>) -> u32
    where I: Iterator<Item=char>
{
    let mut n = 0;
    loop {
        match tokens.peek() {
            Some(r) if r.is_digit(10) => {
                n = n * 10 + r.to_digit(10).unwrap();
            }
            _ => break;
        }
    }
}

```

```

    }
    _ => return n
  }
  tokens.next();
}
}

```

```

let mut chars = "226153980,1766319049".chars().peekable();
assert_eq!(parse_number(&mut chars), 226153980);
// Look, `parse_number` didn't consume the comma! So we will.
assert_eq!(chars.next(), Some(','));
assert_eq!(parse_number(&mut chars), 1766319049);
assert_eq!(chars.next(), None);

```

The `parse_number` function uses `peek` to check the next character, and consumes it only if it is a digit. If it isn't a digit or the iterator is exhausted (that is, if `peek` returns `None`), we return the number we've parsed and leave the next character in the iterator, ready to be consumed.

## fuse

Once an `Iterator` has returned `None`, the trait doesn't specify how it ought to behave if you call its `next` method again. Most iterators just return `None` again, but not all. If your code counts on that behavior, you may be in for a surprise.

The `fuse` adapter takes any iterator and turns into one that will definitely continue to return `None` once it has done so the first time:

```

struct Flaky(bool);

impl Iterator for Flaky {
  type Item = &'static str;
  fn next(&mut self) -> Option<Self::Item> {
    if self.0 {
      self.0 = false;
      Some("totally the last item")
    } else {
      self.0 = true; // D'oh!
      None
    }
  }
}

let mut flaky = Flaky(true);
assert_eq!(flaky.next(), Some("totally the last item"));
assert_eq!(flaky.next(), None);
assert_eq!(flaky.next(), Some("totally the last item"));

let mut not_flaky = Flaky(true).fuse();
assert_eq!(not_flaky.next(), Some("totally the last item"));

```



```
assert_eq!(not_flaky.next(), None);
assert_eq!(not_flaky.next(), None);
```

The fuse adapter is probably most useful in generic code that needs to work with iterators of uncertain origin. Rather than hoping that every iterator you'll have to deal with will be well-behaved, you can use fuse to make sure.

## Reversible Iterators and rev

Some iterators are able to draw items from both ends of the sequence. You can reverse such iterators by using the rev adapter. For example, an iterator over a vector could just as easily draw items from the end of the vector as from the start. Such iterators can implement the `std::iter::DoubleEndedIterator` trait, which extends `Iterator`:

```
trait DoubleEndedIterator: Iterator {
    fn next_back(&mut self) -> Option<Self::Item>;
}
```

You can think of a double-ended iterator as having two fingers marking the current front and back of the sequence. Drawing items from either end advances that finger toward the other; when the two meet, the iteration is done:

```
use std::iter::DoubleEndedIterator;

let bee_parts = ["head", "thorax", "abdomen"];

let mut iter = bee_parts.iter();
assert_eq!(iter.next(), Some(&"head"));
assert_eq!(iter.next_back(), Some(&"abdomen"));
assert_eq!(iter.next(), Some(&"thorax"));

assert_eq!(iter.next_back(), None);
assert_eq!(iter.next(), None);
```

The structure of an iterator over a slice makes this behavior easy to implement: it is literally a pair of pointers to the start and end of the range of elements we haven't yet produced; `next` and `next_back` simply draw an item from the one or the other. Iterators for ordered collections like `BTreeSet` and `BTreeMap` are double-ended too: their `next_back` method draws the greatest elements or entries first. In general, the standard library provides double-ended iteration whenever it's practical.

But not all iterators can do this so easily: an iterator producing values from other threads arriving at a channel's `Receiver` has no way to anticipate what the last value received might be. In general, you'll need to check the standard library's documentation to see which iterators implement `DoubleEndedIterator` and which don't.

If an iterator is double-ended, you can reverse it with the `rev` adapter:

```
fn rev(self) -> some Iterator<Item=Self>
    where Self: Sized + DoubleEndedIterator;
```

The returned iterator is also double-ended: its `next` and `next_back` methods are simply exchanged:

```
let meals = ["breakfast", "lunch", "dinner"];

let mut iter = meals.iter().rev();
assert_eq!(iter.next(), Some(&"dinner"));
assert_eq!(iter.next(), Some(&"lunch"));
assert_eq!(iter.next(), Some(&"breakfast"));
assert_eq!(iter.next(), None);
```

Most iterator adapters, if applied to a reversible iterator, return another reversible iterator. For example, `map` and `filter` preserve reversibility.

## inspect

The `inspect` adapter is handy for debugging pipelines of iterator adapters, but it isn't used much in production code. It simply applies a closure to a shared reference to each item, and then passes the item through. The closure can't affect the items, but it can do things like print them or make assertions about them.

This example shows a case in which converting a string to uppercase changes its length:

```
let upper_case: String = "groÙe".chars()
    .inspect(|c| println!("before: {:?}", c))
    .flat_map(|c| c.to_uppercase())
    .inspect(|c| println!(" after:   {:?}", c))
    .collect();
assert_eq!(upper_case, "GROSSE");
```

The uppercase equivalent of the lowercase German letter “ß” is “SS”, which is why `char::to_uppercase` returns an iterator over characters, not a single replacement character. The preceding code uses `flat_map` to concatenate all the sequences that `to_uppercase` returns into a single `String`, printing the following as it does so:

```
before: 'g'
after:   'G'
before: 'r'
after:   'R'
before: 'o'
after:   'O'
before: 'ß'
after:   'S'
after:   'S'
before: 'e'
after:   'E'
```

## chain

The `chain` adapter appends one iterator to another. More precisely, `i1.chain(i2)` returns an iterator that draws items from `i1` until it's exhausted, and then draws items from `i2`.

The `chain` adapter's signature is as follows:

```
fn chain<U>(self, other: U) -> some Iterator<Item=Self::Item>
    where Self: Sized, U: IntoIterator<Item=Self::Item>;
```

In other words, you can chain an iterator together with any iterable that produces the same item type.

For example:

```
let v: Vec<i32> = (1..4).chain(vec![20, 30, 40]).collect();
assert_eq!(v, [1, 2, 3, 20, 30, 40]);
```

A `chain` iterator is reversible, if both of its underlying iterators are:

```
let v: Vec<i32> = (1..4).chain(vec![20, 30, 40]).rev().collect();
assert_eq!(v, [40, 30, 20, 3, 2, 1]);
```

A `chain` iterator keeps track of whether each of the two underlying iterators has returned `None`, and directs `next` and `next_back` calls to one or the other as appropriate.

## enumerate

The `Iterator` trait's `enumerate` adapter attaches a running index to the sequence, taking an iterator that produces items `A`, `B`, `C`, ... and returning an iterator that produces pairs `(0, A)`, `(1, B)`, `(2, C)`, ... It looks trivial at first glance, but it's used surprisingly often.

Consumers can use that index to distinguish one item from another, and establish the context in which to process each one. For example, the Mandelbrot set plotter in [Chapter 2](#) splits the image into eight horizontal bands and assigns each one to a different thread. That code uses `enumerate` to tell each thread which portion of the image its band corresponds to.

Starting with a rectangular buffer of pixels:

```
let mut pixels = vec![0; columns * rows];
```

It uses `chunks_mut` to split the image into horizontal bands, one per thread:

```
let threads = 8;
let band_rows = rows / threads + 1;
...
let bands: Vec<&mut [u8]> = pixels.chunks_mut(band_rows * columns).collect();
```

And then it iterates over the bands, starting a thread for each one:

```
for (i, band) in bands.into_iter().enumerate() {
    let top = band_rows * i;
    // start a thread to render rows `top..top + band_rows`
}
```

Each iteration gets a pair `(i, band)`, where `band` is the `&mut [u8]` slice of the pixel buffer the thread should draw into, and `i` is the index of that band in the overall image, courtesy of the `enumerate` adapter. Given the boundaries of the plot and the size of the bands, this is enough information for the thread to determine which portion of the image it has been assigned, and thus what to draw into `band`.

## zip

The `zip` adapter combines two iterators into a single iterator that produces pairs holding one value from each iterator, like a zipper joining its two sides into a single seam. The zipped iterator ends when either of the two underlying iterators ends.

For example, you can get the same effect as the `enumerate` adapter by zipping the half-open range `0..` with the other iterator:

```
let v: Vec<_> = (0..).zip("ABCD".chars()).collect();
assert_eq!(v, vec![(0, 'A'), (1, 'B'), (2, 'C'), (3, 'D')]);
```

In this sense, you can think of `zip` as a generalization of `enumerate`: whereas `enumerate` attaches indices to the sequence, `zip` attaches any arbitrary iterator's items. We suggested before that `enumerate` can help provide context for processing items; `zip` is a more flexible way to do the same.

The argument to `zip` doesn't need to be an iterator itself; it can be any iterable:

```
use std::iter::repeat;

let endings = vec!["once", "twice", "chicken soup with rice"];
let rhyme: Vec<_> = repeat("going")
    .zip(endings)
    .collect();
assert_eq!(rhyme, vec![("going", "once"),
    ("going", "twice"),
    ("going", "chicken soup with rice")]);
```

## by\_ref

Throughout this section, we've been attaching adapters to iterators. Once you've done so, can you ever take the adapter off again? Usually, no: adapters take ownership of the underlying iterator, and provide no method to give it back.

An iterator's `by_ref` method borrows a mutable reference to the iterator, so that you can apply adaptors to the reference. When you're done consuming items from these adaptors, you drop them, the borrow ends, and you regain access to your original iterator.

For example, earlier in the chapter we showed how to use `take_while` and `skip_while` to process the header lines and body of a mail message. But what if you want to do both, using the same underlying iterator? Using `by_ref`, we can use `take_while` to handle the headers, and when that's done, get the underlying iterator back, which `take_while` has left exactly in position to handle the message body:

```
let message = "To: jimb\r\n\
              From: id\r\n\
              \r\n\
              Ooooooh, donuts!!\r\n";

let mut lines = message.lines();

println!("Headers:");
for header in lines.by_ref().take_while(|l| !l.is_empty()) {
    println!("{}", header);
}

println!("\nBody:");
for body in lines {
    println!("{}", body);
}
```

The call `lines.by_ref()` borrows a mutable reference to the iterator, and it is this reference that the `take_while` iterator takes ownership of. That iterator goes out of scope at the end of the first `for` loop, meaning that the borrow has ended, so you can use `lines` again in the second `for` loop. This prints the following:

```
Headers:
To: jimb
From: id

Body:
Ooooooh, donuts!!
```

The `by_ref` adapter's definition is trivial: it returns a mutable reference to the iterator. Then, the standard library includes this strange little implementation:

```
impl<'a, I: Iterator + ?Sized> Iterator for &'a mut I {
    type Item = I::Item;
    fn next(&mut self) -> Option<I::Item> {
        (**self).next()
    }
    fn size_hint(&self) -> (usize, Option<usize>) {
        (**self).size_hint()
    }
}
```

```
    }  
}
```

In other words, if `I` is some iterator type, then `&mut I` is an iterator too, whose `next` and `size_hint` methods defer to its referent. When you call an adapter on a mutable reference to an iterator, the adapter takes ownership of the *reference*, not the iterator itself. That's just a borrow that ends when the adapter goes out of scope.

## cloned

The `cloned` adapter takes an iterator that produces references, and returns an iterator that produces values cloned from those references. Naturally, the referent type must implement `Clone`. For example:

```
let a = ['1', '2', '3', '∞'];  
  
assert_eq!(a.iter().next(), Some(&'1'));  
assert_eq!(a.iter().cloned().next(), Some('1'));
```

## cycle

The `cycle` adapter returns an iterator that endlessly repeats the sequence produced by the underlying iterator. The underlying iterator must implement `std::clone::Clone`, so that `cycle` can save its initial state and reuse it each time the cycle starts again.

For example:

```
let dirs = ["North", "East", "South", "West"];  
let mut spin = dirs.iter().cycle();  
assert_eq!(spin.next(), Some(&"North"));  
assert_eq!(spin.next(), Some(&"East"));  
assert_eq!(spin.next(), Some(&"South"));  
assert_eq!(spin.next(), Some(&"West"));  
assert_eq!(spin.next(), Some(&"North"));  
assert_eq!(spin.next(), Some(&"East"));
```

Or, for a really gratuitous use of iterators:

```
use std::iter::{once, repeat};  
  
let fizzes = repeat("").take(2).chain(once("fizz")).cycle();  
let buzzes = repeat("").take(4).chain(once("buzz")).cycle();  
let fizzes_buzzes = fizzes.zip(buzzes);  
  
let fizz_buzz = (1..100).zip(fizzes_buzzes)  
    .map(|tuple|  
        match tuple {  
            (i, ("", "")) => i.to_string(),  
            (_, (fizz, buzz)) => format!("{}", fizzes_buzzes, fizz, buzz)  
        });
```

```

for line in fizz_buzz {
    println!("{}", line);
}

```

This plays a children’s word game, now sometimes used as a job interview question for coders, in which the players take turns counting, replacing any number divisible by three with the word “fizz”, and any number divisible by five with “buzz”. Numbers divisible by both become “fizzbuzz”.

## Consuming Iterators

So far we’ve covered creating iterators, and adapting them into new iterators; here we finish off the process by showing ways to consume them.

Of course, you can consume an iterator with a for loop, or call `next` explicitly, but there are many common tasks that you shouldn’t have to write out again and again. The `Iterator` trait provides a broad selection of methods to cover many of these.

### Simple Accumulation: count, sum, product

The `count` method draws items from an iterator until it returns `None`, and tells you how many it got. Here’s a short program that counts the number of lines on its standard input:

```

use std::io::prelude::*;

fn main() {
    let stdin = std::io::stdin();
    println!("{}", stdin.lock().lines().count());
}

```

The `sum` and `product` methods compute the sum or product of the iterator’s items, which must be integers or floating-point numbers:

```

fn triangle(n: u64) -> u64 {
    (1..n+1).sum()
}
assert_eq!(triangle(20), 210);

fn factorial(n: u64) -> u64 {
    (1..n+1).product()
}
assert_eq!(factorial(20), 2432902008176640000);

```

(You can extend `sum` and `product` to work with other types by implementing the `std::iter::Sum` and `std::iter::Product` traits, which we won’t describe in this book.)

## max, min

The `min` and `max` methods on `Iterator` return the least or greatest item the iterator produces. The iterator's item type must implement `std::cmp::Ord`, so that items can be compared with one another. For example:

```
assert_eq!([-2, 0, 1, 0, -2, -5].iter().max(), Some(&1));
assert_eq!([-2, 0, 1, 0, -2, -5].iter().min(), Some(&-5));
```

These methods return an `Option<Self::Item>`, so that they can return `None` if the iterator produces no items.

As explained in “Equality Tests” on page 272, Rust's floating-point types `f32` and `f64` implement only `std::cmp::PartialOrd`, not `std::cmp::Ord`, so you can't use the `min` and `max` methods to compute the least or greatest of a sequence of floating-point numbers. This is not a popular aspect of Rust's design, but it is deliberate: it's not clear what such functions should do with IEEE NaN values. Simply ignoring them would risk masking more serious problems in the code.

If you know how you would like to handle NaN values, you can use the `max_by` and `min_by` iterator methods instead, which let you supply your own comparison function.

## max\_by, min\_by

The `max_by` and `min_by` methods return the maximum or minimum item the iterator produces, as determined by a comparison function you provide:

```
use std::cmp::{PartialOrd, Ordering};

// Compare two f64 values. Panic if given a NaN.
fn cmp(lhs: &&f64, rhs: &&f64) -> Ordering {
    lhs.partial_cmp(rhs).unwrap()
}

let numbers = [1.0, 4.0, 2.0];
assert_eq!(numbers.iter().max_by(cmp), Some(&4.0));
assert_eq!(numbers.iter().min_by(cmp), Some(&1.0));

let numbers = [1.0, 4.0, std::f64::NAN, 2.0];
assert_eq!(numbers.iter().max_by(cmp), Some(&4.0)); // panics
```

(The double references in `cmp`'s parameters arise because `numbers.iter()` produces references to the elements, and then `max_by` and `min_by` pass the closure references to the iterator's items.)



## max\_by\_key, min\_by\_key

The `max_by_key` and `min_by_key` methods on `Iterator` let you select the maximum or minimum item as determined by a closure applied to each item. The closure can select some field of the item, or perform a computation on the items. Since you're often interested in data associated with some minimum or maximum, not just the extremum itself, these functions are often more useful than `min` and `max`. Their signatures are as follows:

```
fn min_by_key<B: Ord, F>(self, f: F) -> Option<Self::Item>
    where Self: Sized, F: FnMut(&Self::Item) -> B;

fn max_by_key<B: Ord, F>(self, f: F) -> Option<Self::Item>
    where Self: Sized, F: FnMut(&Self::Item) -> B;
```

That is, given a closure that takes an item and returns any ordered type `B`, return the item for which the closure returned the maximum or minimum `B`, or `None` if no items were produced.

For example, if you need to scan a hash table of cities to find the cities with the largest and smallest populations, you could write:

```
use std::collections::HashMap;

let mut populations = HashMap::new();
populations.insert("Portland", 583_776);
populations.insert("Fossil", 449);
populations.insert("Greenhorn", 2);
populations.insert("Boring", 7_762);
populations.insert("The Dalles", 15_340);

assert_eq!(populations.iter().max_by_key(|&(_name, pop)| pop),
           Some((&"Portland", &583_776)));
assert_eq!(populations.iter().min_by_key(|&(_name, pop)| pop),
           Some((&"Greenhorn", &2)));
```

The closure `|&(_name, pop)| pop` gets applied to each item the iterator produces, and returns the value to use for comparison—in this case, the city's population. The value returned is the entire item, not just the value the closure returns. (Naturally, if you were making queries like this often, you'd probably want to arrange for a more efficient way to find the entries than making a linear search through the table.)

## Comparing Item Sequences

You can use the `<` and `==` operators to compare strings, vectors, and slices, assuming their individual elements can be compared. Although iterators do not support Rust's comparison operators, they do provide methods like `eq` and `lt` that do the same job, drawing pairs of items from the iterators and comparing them until a decision can be reached. For example:

```

let packed = "Helen of Troy";
let spaced = "Helen  of  Troy";
let obscure = "Helen of Sandusky"; // nice person, just not famous

assert!(packed != spaced);
assert!(packed.split_whitespace().eq(spaced.split_whitespace()));

// This is true because ' ' < 'o'.
assert!(spaced < obscure);

// This is true because 'Troy' > 'Sandusky'.
assert!(spaced.split_whitespace().gt(obscure.split_whitespace()));

```

The calls to `split_whitespace` return iterators over the whitespace-separated words of the string. Using the `eq` and `gt` methods on these iterators performs a word-by-word comparison, instead of a character-by-character comparison. These are all possible because `&str` implements `PartialOrd` and `PartialEq`.

Iterators provide the `eq` and `ne` methods for equality comparisons, and `lt`, `le`, `gt`, and `ge` methods for ordered comparisons. The `cmp` and `partial_cmp` methods behave like the corresponding methods of the `Ord` and `PartialOrd` traits.

## any and all

The `any` and `all` methods apply a closure to each item the iterator produces, and return `true` if the closure returns `true` for any item, or for all the items:

```

let id = "Iterator";

assert!(id.chars().any(char::is_uppercase));
assert!(!id.chars().all(char::is_uppercase));

```

These methods consume only as many items as they need to determine the answer. For example, if the closure ever returns `true` for a given item, then `any` returns `true` immediately, without drawing any more items from the iterator.

## position, rposition, and ExactSizeIterator

The `position` method applies a closure to each item from the iterator and returns the index of the first item for which the closure returns `true`. More precisely, it returns an `Option` of the index: if the closure returns `true` for no item, `position` returns `None`. It stops drawing items as soon as the closure returns `true`. For example:

```

let text = "Xerxes";
assert_eq!(text.chars().position(|c| c == 'e'), Some(1));
assert_eq!(text.chars().position(|c| c == 'z'), None);

```

The `rposition` method is the same, except that it searches from the right. For example:

```

let bytes = b"Xerxes";
assert_eq!(bytes.iter().rposition(|&c| c == b'e'), Some(4));
assert_eq!(bytes.iter().rposition(|&c| c == b'X'), Some(0));

```

The `rposition` method requires a reversible iterator, so that it can draw items from the right end of the sequence. It also requires an exact-size iterator, so that it can assign indices the same way `position` would, starting with 0 at the left. An exact-size iterator is one that implements the `std::iter::ExactSizeIterator` trait:

```

pub trait ExactSizeIterator: Iterator {
    fn len(&self) -> usize { ... }
    fn is_empty(&self) -> bool { ... }
}

```

The `len` method returns the number of items remaining, and the `is_empty` method returns true if iteration is complete.

Naturally, not every iterator knows how many items it will produce in advance; in the preceding examples, the `chars` iterator on `&str` does not (UTF-8 is a variable-width encoding), so you can't use `rposition` on strings. But an iterator over an array of bytes certainly knows the array's length, so it can implement `ExactSizeIterator`.

## fold

The `fold` method is a very general tool for accumulating some sort of result over the entire sequence of items an iterator produces. Given an initial value, which we'll call the *accumulator*, and a closure, `fold` repeatedly applies the closure to the current accumulator and the next item from the iterator. The value the closure returns is taken as the new accumulator, to be passed to the closure with the next item. The final accumulator value is what `fold` itself returns. If the sequence is empty, `fold` simply returns the initial accumulator.

Many of the other methods for consuming an iterator's values can be written as uses of `fold`:

```

let a = [5, 6, 7, 8, 9, 10];

assert_eq!(a.iter().fold(0, |n, _| n+1), 6);           // count
assert_eq!(a.iter().fold(0, |n, i| n+i), 45);        // sum
assert_eq!(a.iter().fold(1, |n, i| n*i), 151200);    // product

// max
assert_eq!(a.iter().fold(i32::min_value(), |m, &i| std::cmp::max(m, i)),
           10);

```

The `fold` method's signature is as follows:

```

fn fold<A, F>(self, init: A, f: F) -> A
    where Self: Sized, F: FnMut(A, Self::Item) -> A;

```

Here, `A` is the accumulator type. The `init` argument is an `A`, as is the closure's first argument and return value, and the return value of `fold` itself.

Note that the accumulator values are moved into and out of the closure, so you can use `fold` with non-Copy accumulator types:

```
let a = ["Pack ", "my ", "box ", "with ",
        "five ", "dozen ", "liquor ", "jugs"];

let pangram = a.iter().fold(String::new(),
                          |mut s, &w| { s.push_str(w); s });
assert_eq!(pangram, "Pack my box with five dozen liquor jugs");
```

## nth

The `nth` method takes an index `n`, skips that many items from the iterator, and returns the next item, or `None` if the sequence ends before that point. Calling `.nth(0)` is equivalent to `.next()`.

It doesn't take ownership of the iterator the way an adapter would, so you can call it many times.

```
let mut squares = (0..10).map(|i| i*i);

assert_eq!(squares.nth(4), Some(16));
assert_eq!(squares.nth(0), Some(25));
assert_eq!(squares.nth(6), None);
```

Its signature is shown here:

```
fn nth(&mut self, n: usize) -> Option<Self::Item>
    where Self: Sized;
```

## last

The `last` method consumes items until the iterator returns `None`, and then returns the last item. If the iterator produces no items, then `last` returns `None`. Its signature is as follows:

```
fn last(self) -> Option<Self::Item>;
```

For example:

```
let squares = (0..10).map(|i| i*i);
assert_eq!(squares.last(), Some(81));
```

This consumes all the iterator's items starting from the front, even if the iterator is reversible. If you have a reversible iterator and don't need to consume all its items, you should instead just write `iter.rev().next()`.

## find

The `find` method draws items from an iterator, returning the first item for which the given closure returns `true`, or `None` if the sequence ends before a suitable item is found. Its signature is:

```
fn find<P>(&mut self, predicate: P) -> Option<Self::Item>
    where Self: Sized,
          P: FnMut(&Self::Item) -> bool;
```

For example, using the table of cities and populations from “`max_by_key`, `min_by_key`” on page 347, you could write:

```
assert_eq!(populations.iter().find(|&(_name, &pop)| pop > 1_000_000),
           None);
assert_eq!(populations.iter().find(|&(_name, &pop)| pop > 500_000),
           Some((&"Portland", &583_776)));
```

None of the cities in the table have a population above a million, but there is one city with half a million people.

## Building Collections: collect and FromIterator

Throughout the book, we’ve been using the `collect` method to build vectors holding an iterator’s items. For example, in [Chapter 2](#), we called `std::env::args()` to get an iterator over the program’s command-line arguments, and then called that iterator’s `collect` method to gather them into a vector:

```
let args: Vec<String> = std::env::args().collect();
```

But `collect` isn’t specific to vectors: in fact, it can build any kind of collection from Rust’s standard library, as long as the iterator produces a suitable item type:

```
use std::collections::{HashSet, BTreeSet, LinkedList, HashMap, BTreeMap};
```

```
let args: HashSet<String> = std::env::args().collect();
let args: BTreeSet<String> = std::env::args().collect();
let args: LinkedList<String> = std::env::args().collect();
```

```
// Collecting a map requires (key, value) pairs, so for this example,
// zip the sequence of strings with a sequence of integers.
let args: HashMap<String, usize> = std::env::args().zip(0..).collect();
let args: BTreeMap<String, usize> = std::env::args().zip(0..).collect();
```

```
// and so on
```

Naturally, `collect` itself doesn’t know how to construct all these types. Rather, when some collection type like `Vec` or `HashMap` knows how to construct itself from an iterator, it implements the `std::iter::FromIterator` trait, for which `collect` is just a convenient veneer:

```

trait FromIterator<A>: Sized {
    fn from_iter<T: IntoIterator<Item=A>>(iter: T) -> Self;
}

```

If a collection type implements `FromIterator<A>`, then its static method `from_iter` builds a value of that type from an iterable producing items of type `A`.

In the simplest case, the implementation could simply construct an empty collection, and then add the items from the iterator one by one. For example, `std::collections::LinkedList`'s implementation of `FromIterator` works this way.

However, some types can do better than that. For example, constructing a vector from some iterator `iter` could be as simple as:

```

let mut vec = Vec::new();
for item in iter {
    vec.push(item)
}
vec

```

But this isn't ideal: as the vector grows, it may need to expand its buffer, requiring a call to the heap allocator and a copy of the extant elements. Vectors do take algorithmic measures to keep this overhead low, but if there were some way to simply allocate an initial buffer of the right size to begin with, there would be no need to resize at all.

This is where the `Iterator` trait's `size_hint` method comes in:

```

trait Iterator {
    ...
    fn size_hint(&self) -> (usize, Option<usize>) {
        (0, None)
    }
}

```

This method returns a lower bound and optional upper bound on the number of items the iterator will produce. The default definition returns zero as the lower bound and declines to name an upper bound, saying, in effect, "I have no idea," but many iterators can do better than this. An iterator over a `Range`, for example, knows exactly how many items it will produce, as does an iterator over a `Vec` or `HashMap`. Such iterators provide their own specialized definitions for `size_hint`.

These bounds are exactly the information that `Vec`'s implementation of `FromIterator` needs to size the new vector's buffer correctly from the start. Insertions still check that the buffer is large enough, so even if the hint is incorrect, only performance is affected, not safety. Other types can take similar steps: for example, `HashSet` and `HashMap` also use `Iterator::size_hint` to choose an appropriate initial size for their hash table.

One note about type inference: at the top of this section, it's a bit strange to see the same call, `std::env::args().collect()`, produce four different kinds of collections

depending on its context. The return type of `collect` is its type parameter, so the first two calls are equivalent to the following:

```
let args = std::env::args().collect::<String>();
let args = std::env::args().collect::<HashSet<String>>();
```

But as long as there's only one type that could possibly work as `collect`'s argument, Rust's type inference will supply it for you. When you spell out the type of `args`, you ensure this is the case.

## The Extend Trait

If a type implements the `std::iter::Extend` trait, then its `extend` method adds an iterable's items to the collection:

```
let mut v: Vec<i32> = (0..5).map(|i| 1 << i).collect();
v.extend(&[31, 57, 99, 163]);
assert_eq!(v, &[1, 2, 4, 8, 16, 31, 57, 99, 163]);
```

All of the standard collections implement `Extend`, so they all have this method; so does `String`. Arrays and slices, which have a fixed length, do not.

The trait's definition is as follows:

```
trait Extend<A> {
    fn extend<T>(&mut self, iter: T)
        where T: IntoIterator<Item=A>;
}
```

Obviously, this is very similar to `std::iter::FromIterator`: that creates a new collection, whereas `Extend` extends an existing collection. In fact, several implementations of `FromIterator` in the standard library simply create a new empty collection, and then call `extend` to populate it. For example, the implementation of `FromIterator` for `std::collections::LinkedList` works this way:

```
impl<T> FromIterator<T> for LinkedList<T> {
    fn from_iter<I: IntoIterator<Item = T>>(iter: I) -> Self {
        let mut list = Self::new();
        list.extend(iter);
        list
    }
}
```

## partition

The `partition` method divides an iterator's items among two collections, using a closure to decide where each item belongs:

```
let things = ["doorknob", "mushroom", "noodle", "giraffe", "grapefruit"];

// Amazing fact: the name of a living thing always starts with an
```

```

// odd-numbered letter.
let (living, nonliving): (Vec<&str>, _)
    = things.iter().partition(|name| name.as_bytes()[0] & 1 != 0);

assert_eq!(living,    vec!["mushroom", "giraffe", "grapefruit"]);
assert_eq!(nonliving, vec!["doorknob", "noodle"]);

```

Like `collect`, `partition` can make any sort of collection you like (although both must be of the same type). And like `collect`, you'll need to specify the return type: the preceding example writes out the type of `living` and `nonliving`, and lets type inference choose the right type parameters for the call.

The signature of `partition` is as follows:

```

fn partition<B, F>(self, f: F) -> (B, B)
    where Self: Sized,
           B: Default + Extend<Self::Item>,
           F: FnMut(&Self::Item) -> bool;

```

Whereas `collect` requires its result type to implement `FromIterator`, `partition` instead requires `std::default::Default`, which all Rust collections implement by returning an empty collection, and `std::default::Extend`.

Why doesn't `partition` just split the iterator into two iterators, instead of building two collections? One reason is that items drawn from the underlying iterator but not yet drawn from the appropriate partitioned iterator would need to be buffered somewhere; you would end up building a collection of some sort internally, anyway. But the more fundamental reason has to do with safety. Partitioning one iterator into two would require the two partitions to share the same underlying iterator. Iterators must be mutable to be used; so the underlying iterator would necessarily be shared, mutable state, which Rust's safety depends on avoiding.

## Implementing Your Own Iterators

You can implement the `IntoIterator` and `Iterator` traits for your own types, making all the adapters and consumers shown in this chapter available for use, along with lots of other library and crate code written to work with the standard iterator interface. In this section, we'll show a simple iterator over a range type, and then a more complex iterator over a binary tree type.

Suppose we have the following range type (simplified from the standard library's `std::ops::Range<T>` type):

```

struct I32Range {
    start: i32,
    end: i32
}

```



Iterating over an `I32Range` requires two pieces of state: the current value, and the limit at which the iteration should end. This happens to be a nice fit for the `I32Range` type itself, using `start` as the next value, and `end` as the limit. So you can implement `Iterator` like so:

```
impl Iterator for I32Range {
    type Item = i32;
    fn next(&mut self) -> Option<i32> {
        if self.start >= self.end {
            return None;
        }
        let result = Some(self.start);
        self.start += 1;
        result
    }
}
```

This iterator produces `i32` items, so that's the `Item` type. If the iteration is complete, `next` returns `None`; otherwise, it produces the next value, and updates its state to prepare for the next call.

Of course, a `for` loop uses `IntoIterator::into_iter` to convert its operand into an iterator. But the standard library provides a blanket implementation of `IntoIterator` for every type that implements `Iterator`, so `I32Range` is ready for use:

```
let mut pi = 0.0;
let mut numerator = 1.0;

for k in (I32Range { start: 0, end: 14 }) {
    pi += numerator / (2*k + 1) as f64;
    numerator /= -3.0;
}

pi *= f64::sqrt(12.0);

// IEEE 754 specifies this result exactly.
assert_eq!(pi as f32, std::f32::consts::PI);
```

But `I32Range` is a special case, in that the iterable and iterator are the same type. Many cases aren't so simple. For example, here's the binary tree type from [Chapter 10](#):

```
enum BinaryTree<T> {
    Empty,
    NonEmpty(Box<TreeNode<T>>)
}

struct TreeNode<T> {
    element: T,
    left: BinaryTree<T>,
    right: BinaryTree<T>
}
```

The classic way to walk a binary tree is to recurse, using the stack of function calls to keep track of your place in the tree and the nodes yet to be visited. But when implementing `Iterator` for `BinaryTree<T>`, each call to `next` must produce exactly one value and return. To keep track of the tree nodes it has yet to produce, the iterator must maintain its own stack. Here's one possible iterator type for `BinaryTree`:

```
use self::BinaryTree::*;

// The state of an in-order traversal of a `BinaryTree`.
struct TreeIter<'a, T: 'a> {
    // A stack of references to tree nodes. Since we use `Vec`'s
    // `push` and `pop` methods, the top of the stack is the end of the
    // vector.
    //
    // The node the iterator will visit next is at the top of the stack,
    // with those ancestors still unvisited below it. If the stack is empty,
    // the iteration is over.
    unvisited: Vec<&'a TreeNode<T>>
}

```

It turns out that pushing the nodes running down the left edge of a subtree is a common operation, so we'll define a method on `TreeIter` to do that:

```
impl<'a, T: 'a> TreeIter<'a, T> {
    fn push_left_edge(&mut self, mut tree: &'a BinaryTree<T>) {
        while let NonEmpty(ref node) = *tree {
            self.unvisited.push(node);
            tree = &node.left;
        }
    }
}

```

With this helper method in place, we can give `BinaryTree` an `iter` method that returns an iterator over the tree:

```
impl<T> BinaryTree<T> {
    fn iter(&self) -> TreeIter<T> {
        let mut iter = TreeIter { unvisited: Vec::new() };
        iter.push_left_edge(self);
        iter
    }
}

```

The `iter` method constructs an empty `TreeIter`, and then calls `push_left_edge` to set up the initial stack. The leftmost node ends up on the top, as required by the `unvisited` stack's rules.

Following the standard library's practices, we can then implement `IntoIterator` on a shared reference to a tree with a call to `BinaryTree::iter`:

```
impl<'a, T: 'a> IntoIterator for &'a BinaryTree<T> {
    type Item = &'a T;
}

```

```

    type IntoIter = TreeIter<'a, T>;
    fn into_iter(self) -> Self::IntoIter {
        self.iter()
    }
}

```

The IntoIter definition establishes TreeIter as the iterator type for a &BinaryTree.

Finally, in the Iterator implementation, we get to actually walk the tree. Like BinaryTree's iter method, the iterator's next method is guided by the stack's rules:

```

impl<'a, T> Iterator for TreeIter<'a, T> {
    type Item = &'a T;
    fn next(&mut self) -> Option<&'a T> {
        // Find the node this iteration must produce,
        // or finish the iteration.
        let node = match self.unvisited.pop() {
            None => return None,
            Some(n) => n
        };

        // The next node after this one is the leftmost child of
        // this node's right child, so push the path from here down.
        self.push_left_edge(&node.right);

        // Produce a reference to this node's value.
        Some(&node.element)
    }
}

```

If the stack is empty, the iteration is complete. Otherwise, node is a reference to the node to visit now; this call will return a reference to its element field. But first, we must advance the iterator's state to the next node. If this node has a right subtree, the next node to visit is the subtree's leftmost node, and we can use push\_left\_edge to push it, and its unvisited ancestors, onto the stack. But if this node has no right subtree, push\_left\_edge has no effect, which is just what we want: we can count on the new top of the stack to be node's first unvisited ancestor, if any.

With IntoIterator and Iterator implementations in place, we can finally use a for loop to iterate over a BinaryTree by reference:

```

fn make_node<T>(left: BinaryTree<T>, element: T, right: BinaryTree<T>)
    -> BinaryTree<T>
{
    NonEmpty(Box::new(TreeNode { left, element, right }))
}

// Build a small tree.
let subtree_l = make_node(Empty, "mecha", Empty);
let subtree_rl = make_node(Empty, "droid", Empty);
let subtree_r = make_node(subtree_rl, "robot", Empty);

```

```

let tree = make_node(subtree_l, "Jaeger", subtree_r);

// Iterate over it.
let mut v = Vec::new();
for kind in &tree {
    v.push(*kind);
}
assert_eq!(v, ["mecha", "Jaeger", "droid", "robot"]);

```

Figure 15-1 shows how the unvisited stack behaves as we iterate through a sample tree. At every step, the next node to be visited is at the top of the stack, with all its unvisited ancestors below it.

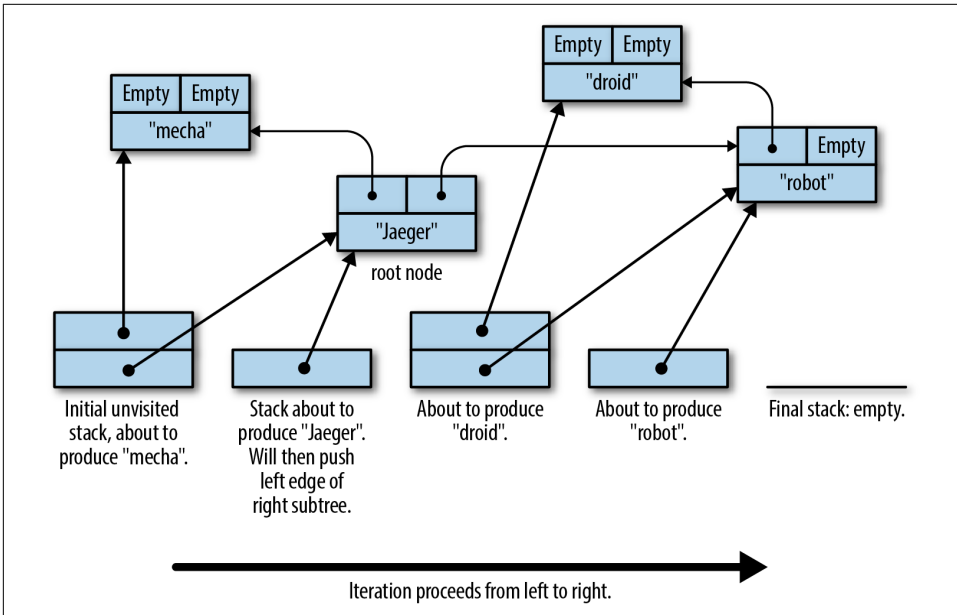

Figure 15-1. Iterating over a binary tree

All the usual iterator adapters and consumers are ready for use on our trees:

```

assert_eq!(tree.iter()
    .map(|name| format!("mega-{}", name))
    .collect:::<Vec<_>>(),
    vec!["mega-mecha", "mega-Jaeger",
        "mega-droid", "mega-robot"]);

```

---

# Collections

*We all behave like Maxwell's demon. Organisms organize. In everyday experience lies the reason sober physicists across two centuries kept this cartoon fantasy alive. We sort the mail, build sand castles, solve jigsaw puzzles, separate wheat from chaff, rearrange chess pieces, collect stamps, alphabetize books, create symmetry, compose sonnets and sonatas, and put our rooms in order, and all this we do requires no great energy, as long as we can apply intelligence.*

—James Gleick, *The Information: A History, a Theory, a Flood*

The Rust standard library contains several *collections*, generic types for storing data in memory. We've already been using collections, such as `Vec` and `HashMap`, throughout this book. In this chapter, we'll cover the methods of these two types in detail, along with the other half-dozen standard collections. Before we begin, let's address a few systematic differences between Rust's collections and those in other languages.

First, moves and borrowing are everywhere. Rust uses moves to avoid deep-copying values. That's why the method `Vec<T>::push(item)` takes its argument by value, not by reference. The value is moved into the vector. The diagrams in [Chapter 4](#) show how this works out in practice: pushing a Rust `String` to a `Vec<String>` is quick, because Rust doesn't have to copy the string's character data, and ownership of the string is always clear.

Second, Rust doesn't have invalidation errors—the kind of dangling-pointer bug where a collection is resized, or otherwise changed, while the program is holding a pointer to data inside it. Invalidation errors are another source of undefined behavior in C++, and they cause the occasional `ConcurrentModificationException` even in memory-safe languages. Rust's borrow checker rules them out at compile time.

Finally, Rust does not have `null`, so we'll see `Options` in places where other languages would use `null`.

Apart from these differences, Rust’s collections are about what you’d expect. If you’re an experienced programmer in a hurry, you can skim here, but don’t miss “[Entries](#)” on page 381.

## Overview

**Table 16-1** shows Rust’s eight standard collections. All of them are generic types.

*Table 16-1. Summary of the standard collections*

Collection	Description	Similar collection type in...		
		C++	Java	Python
<code>Vec&lt;T&gt;</code>	Growable array	<code>vector</code>	<code>ArrayList</code>	<code>list</code>
<code>VecDeque&lt;T&gt;</code>	Double-ended queue (growable ring buffer)	<code>deque</code>	<code>ArrayDeque</code>	<code>collections.deque</code>
<code>LinkedList&lt;T&gt;</code>	Doubly linked list	<code>list</code>	<code>LinkedList</code>	—
<code>BinaryHeap&lt;T&gt;</code> where <code>T: Ord</code>	Max heap	<code>priority_queue</code>	<code>PriorityQueue</code>	<code>heapq</code>
<code>HashMap&lt;K, V&gt;</code> where <code>K: Eq + Hash</code>	Key-value hash table	<code>unordered_map</code>	<code>HashMap</code>	<code>dict</code>
<code>BTreeMap&lt;K, V&gt;</code> where <code>K: Ord</code>	Sorted key-value table	<code>map</code>	<code>TreeMap</code>	—
<code>HashSet&lt;T&gt;</code> where <code>T: Eq + Hash</code>	Hash table	<code>unordered_set</code>	<code>HashSet</code>	<code>set</code>
<code>BTreeSet&lt;T&gt;</code> where <code>T: Ord</code>	Sorted set	<code>set</code>	<code>TreeSet</code>	—

`Vec<T>`, `HashMap<K, V>`, and `HashSet<T>` are the most generally useful collection types. The rest have niche uses. This chapter discusses each collection type in turn:

- `Vec<T>` is a growable, heap-allocated array of values of type `T`. About half of this chapter is dedicated to `Vec` and its many useful methods.
- `VecDeque<T>` is like `Vec<T>`, but better for use as a first-in-first-out queue. It supports efficiently adding and removing values at the front of the list as well as the back. This comes at the cost of making all other operations slightly slower.
- `LinkedList<T>` supports fast access to the front and back of the list, like `VecDeque<T>`, and adds fast concatenation. However, in general, `LinkedList<T>` is slower than `Vec<T>` and `VecDeque<T>`.

- `BinaryHeap<T>` is a priority queue. The values in a `BinaryHeap` are organized so that it's always efficient to find and remove the maximum value.
- `HashMap<K, V>` is a table of key-value pairs. Looking up a value by its key is fast. The entries are stored in an arbitrary order.
- `BTreeMap<K, V>` is like `HashMap<K, V>`, but it keeps the entries sorted by key. A `BTreeMap<String, i32>` stores its entries in `String` comparison order. Unless you need the entries to stay sorted, a `HashMap` is faster.
- `HashSet<T>` is a set of values of type `T`. Adding and removing values is fast, and it's fast to ask whether a given value is in the set or not.
- `BTreeSet<T>` is like `HashSet<T>`, but it keeps the elements sorted by value. Again, unless you need the data sorted, a `HashSet` is faster.

## Vec<T>

We'll assume some familiarity with `Vec`, since we've been using it throughout the book. For an introduction, see [“Vectors” on page 59](#). Here we'll finally describe its methods and its inner workings in depth.

The easiest way to create a vector is to use the `vec!` macro:

```
// Create an empty vector
let mut numbers: Vec<i32> = vec![];

// Create a vector with given contents
let words = vec!["step", "on", "no", "pets"];
let mut buffer = vec![0u8; 1024]; // 1024 zeroed-out bytes
```

As described in [Chapter 4](#), a vector has three fields: the length, the capacity, and a pointer to a heap allocation where the elements are stored. [Figure 16-1](#) shows how the vectors created above would appear in memory. The empty vector, `numbers`, initially has a capacity of 0. No heap memory is allocated for it until the first element is added.

Like all collections, `Vec` implements `std::iter::FromIterator`, so you can create a vector from any iterator using the iterator's `.collect()` method, as described in [“Building Collections: collect and FromIterator” on page 351](#):

```
// Convert another collection to a vector.
let my_vec = my_set.into_iter().collect::<Vec<String>>();
```

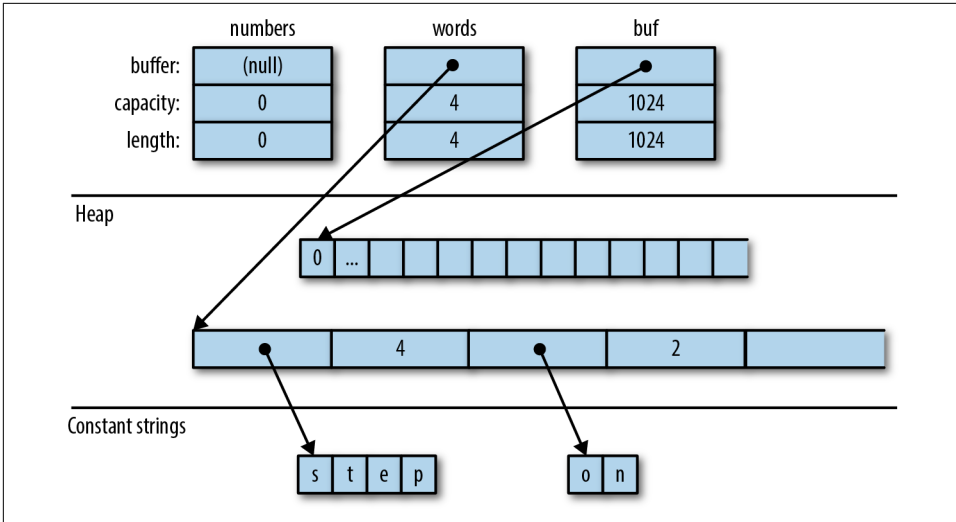

Figure 16-1. Vector layout in memory. Each element of `words` is a `&str` value consisting of a pointer and a length.

## Accessing Elements

Getting elements of an array, slice, or vector by index is straightforward:

```
// Get a reference to an element
let first_line = &lines[0];

// Get a copy of an element
let fifth_number = numbers[4]; // requires Copy
let second_line = lines[1].clone(); // requires Clone

// Get a reference to a slice
let my_ref = &buffer[4..12];

// Get a copy of a slice
let my_copy = buffer[4..12].to_vec(); // requires Clone
```

All of these forms panic if an index is out of bounds.

Rust is picky about numeric types, and it makes no exceptions for vectors. Vector lengths and indices are of type `usize`. Trying to use a `u32`, `u64`, or `isize` as a vector index is an error. You can use an `n` as `usize` cast to convert as needed; see “[Type Casts](#)” on page 139.



Several methods provide easy access to particular elements of a vector or slice (note that all slice methods are available on arrays and vectors too):

- **slice.first()** returns a reference to the first element of slice, if any.

The return type is `Option<T>`, so the return value is `None` if slice is empty and `Some(&slice[0])` if it's not empty.

```
if let Some(item) = v.first() {
    println!("We got one! {}", item);
}
```

- **slice.last()** is similar but returns a reference to the last element.
- **slice.get(index)** returns `Some` reference to `slice[index]`, if it exists. If slice has fewer than `index+1` elements, this returns `None`.

```
let slice = [0, 1, 2, 3];
assert_eq!(slice.get(2), Some(&2));
assert_eq!(slice.get(4), None);
```

- **slice.first\_mut()**, **slice.last\_mut()**, and **slice.get\_mut(index)** are variations of these that borrow `mut` references.

```
let mut slice = [0, 1, 2, 3];
{
    let last = slice.last_mut().unwrap(); // type of last: &mut i32
    assert_eq!(*last, 3);
    *last = 100;
}
assert_eq!(slice, [0, 1, 2, 100]);
```

Because returning a `T` by value would mean moving it, methods that access elements in place typically return those elements by reference.

An exception is the `.to_vec()` method, which makes copies:

- **slice.to\_vec()** clones a whole slice, returning a new vector.

```
let v = [1, 2, 3, 4, 5, 6, 7, 8, 9];
assert_eq!(v.to_vec(),
           vec![1, 2, 3, 4, 5, 6, 7, 8, 9]);
assert_eq!(v[0..6].to_vec(),
           vec![1, 2, 3, 4, 5, 6]);
```

This method is available only if the elements are cloneable, that is, where `T: Clone`.

## Iteration

Vectors and slices are iterable, either by value or by reference, following the pattern described in “[IntoIterator Implementations](#)” on page 325:

- Iterating over a `Vec<T>` produces items of type `T`. The elements are moved out of the vector one by one, consuming it.
- Iterating over a value of type `&[T; N]`, `&[T]`, or `&Vec<T>`—that is, a reference to an array, slice, or vector—produces items of type `&T`, references to the individual elements, which are not moved.
- Iterating over a value of type `&mut [T; N]`, `&mut [T]`, or `&mut Vec<T>` produces items of type `&mut T`.

Arrays, slices, and vectors also have `.iter()` and `.iter_mut()` methods (described in “[iter and iter\\_mut Methods](#)” on page 324) for creating iterators that produce references to their elements.

We’ll cover some fancier ways to iterate over a slice in “[Splitting](#)” on page 368.

## Growing and Shrinking Vectors

The *length* of an array, slice, or vector is the number of elements it contains.

- `slice.len()` returns a slice’s length, as a `usize`.
- `slice.is_empty()` is true if `slice` contains no elements (that is, `slice.len() == 0`).

The remaining methods in this section are about growing and shrinking vectors. They are not present on arrays and slices, which can’t be resized once created.

All of a vector’s elements are stored in a contiguous, heap-allocated chunk of memory. The *capacity* of a vector is the maximum number of elements that would fit in this chunk. `Vec` normally manages the capacity for you, automatically allocating a larger buffer and moving the elements into it when more space is needed. There are also a few methods for managing capacity explicitly:

- `Vec::with_capacity(n)` creates a new, empty vector with capacity `n`.
- `vec.capacity()` returns `vec`’s capacity, as a `usize`. It’s always true that `vec.capacity() >= vec.len()`.
- `vec.reserve(n)` makes sure the vector has at least enough spare capacity for `n` more elements: that is, `vec.capacity()` is at least `vec.len() + n`. If there’s already enough room, this does nothing. If not, this allocates a larger buffer and moves the vector’s contents into it.

- **vec.reserve\_exact(n)** is like `vec.reserve(n)`, but tells `vec` not to allocate any extra capacity for future growth, beyond `n`. Afterward, `vec.capacity()` is exactly `vec.len() + n`.
- **vec.shrink\_to\_fit()** tries to free up the extra memory if `vec.capacity()` is greater than `vec.len()`.

`Vec<T>` has many methods that add or remove elements, changing the vector's length. Each of these takes its `self` argument by `mut` reference.

These two methods add or remove a single value at the end of a vector:

- **vec.push(value)** adds the given `value` to the end of `vec`.
- **vec.pop()** removes and returns the last element. The return type is `Option<T>`. This returns `Some(x)` if the popped element is `x` and `None` if the vector was already empty.

Note that `.push()` takes its argument by value, not by reference. Likewise, `.pop()` returns the popped value, not a reference. The same is true of most of the remaining methods in this section. They move values in and out of vectors.

These two methods add or remove a value anywhere in a vector:

- **vec.insert(index, value)** inserts the given `value` at `vec[index]`, sliding any existing values in `vec[index..]` one spot to the right to make room.  
Panics if `index > vec.len()`.
- **vec.remove(index)** removes and returns `vec[index]`, sliding any existing values in `vec[index+1..]` one spot to the left to close the gap.  
Panics if `index >= vec.len()`, since in that case there is no element `vec[index]` to remove.  
The longer the vector, the slower this operation gets. If you find yourself doing `vec.remove(0)` a lot, consider using a `VecDeque` (explained in [“VecDeque<T>” on page 374](#)) instead of a `Vec`.

Both `.insert()` and `.remove()` are slower the more elements have to be shifted.

Three methods change the length of a vector to a specific value:

- **vec.resize(new\_len, value)** sets `vec`'s length to `new_len`. If this increases `vec`'s length, copies of `value` are added to fill the new space. The element type must implement the `Clone` trait.
- **vec.truncate(new\_len)** reduces the length of `vec` to `new_len`, dropping any elements that were in the range `vec[new_len..]`.

If `vec.len()` is already less than or equal to `new_len`, nothing happens.

- **`vec.clear()`** removes all elements from `vec`. It's the same as `vec.truncate(0)`.

Four methods add or remove many values at once:

- **`vec.extend(iterable)`** adds all items from the given `iterable` value at the end of `vec`, in order. It's like a multivalue version of `.push()`. The `iterable` argument can be anything that implements `IntoIterator<Item=T>`.

This method is so useful that there's a standard trait for it, the `Extend` trait, which all standard collections implement. Unfortunately, this causes `rustdoc` to lump `.extend()` with other trait methods in a big pile at the bottom of the generated HTML, so it's hard to find when you need it. You just have to remember it's there! See [“The Extend Trait” on page 353](#) for more.

- **`vec.split_off(index)`** is like `vec.truncate(index)`, except that it returns a `Vec<T>` containing the values removed from the end of `vec`. It's like a multivalue version of `.pop()`.

- **`vec.append(&mut vec2)`**, where `vec2` is another vector of type `Vec<T>`, moves all elements from `vec2` into `vec`. Afterward, `vec2` is empty.

This is like `vec.extend(vec2)` except that `vec2` still exists afterward, with its capacity unaffected.

- **`vec.drain(range)`**, where `range` is a range value, like `..` or `0..4`, removes the range `vec[range]` from `vec` and returns an iterator over the removed elements.

There are also a few oddball methods for selectively removing some of a vector's elements:

- **`vec.retain(test)`** removes all elements that don't pass the given `test`. The `test` argument is a function or closure that implements `FnMut(&T) -> bool`. For each element of `vec`, this calls `test(&element)`, and if it returns `false`, the element is removed from the vector and dropped.

Apart from performance, this is like writing:

```
vec = vec.into_iter().filter(test).collect();
```

- **`vec.dedup()`** drops repeated elements. It's like the Unix `uniq` shell utility. It scans `vec` for places where adjacent elements are equal and drops the extra equal values, so that only one is left:

```
let mut byte_vec = b"Misssssssissippi".to_vec();
byte_vec.dedup();
assert_eq!(&byte_vec, b"Misisipi");
```

Note that there are still two 's's in the output. This method only removes *adjacent* duplicates. To eliminate all duplicates, you have three options: sort the vector before calling `.dedup()`; move the data into a set; or (to keep the elements in their original order) use this `.retain()` trick:

```
let mut byte_vec = b"Misssssssissippi".to_vec();

let mut seen = HashSet::new();
byte_vec.retain(|r| seen.insert(*r));

assert_eq!(&byte_vec, b"Missp");
```

This works because `.insert()` returns `false` when the set already contains the item we're inserting.

- **`vec.dedup_by(same)`** is the same as `vec.dedup()`, but it uses the function or closure `same(&mut elem1, &mut elem2)`, instead of the `==` operator, to check whether two elements should be considered equal.
- **`vec.dedup_by_key(key)`** is the same as `vec.dedup()`, but it treats two elements as equal if `key(&mut elem1) == key(&mut elem2)`.

For example, if `errors` is a `Vec<Box<Error>>`, you can write:

```
// Remove errors with redundant messages.
errors.dedup_by_key(|err| err.description().to_string());
```

Of all the methods covered in this section, only `.resize()` ever clones values. The others work by moving values from one place to another.

## Joining

Two methods work on *arrays of arrays*, by which we mean any array, slice, or vector whose elements are themselves arrays, slices, or vectors.

- **`lices.concat()`** returns a new vector made by concatenating all the slices.

```
assert_eq!([[1, 2], [3, 4], [5, 6]].concat(),
            vec![1, 2, 3, 4, 5, 6]);
```

- **`lices.join(&separator)`** is the same, except a copy of the value `separator` is inserted between slices:

```
assert_eq!([[1, 2], [3, 4], [5, 6]].join(&0),
            vec![1, 2, 0, 3, 4, 0, 5, 6]);
```

## Splitting

It's easy to get many non-`mut` references into an array, slice, or vector at once:

```
let v = vec![0, 1, 2, 3];
let a = &v[i];
let b = &v[j];

let mid = v.len() / 2;
let front_half = &v[..mid];
let back_half = &v[mid..];
```

Getting multiple `mut` references is not so easy:

```
let mut v = vec![0, 1, 2, 3];
let a = &mut v[i];
let b = &mut v[j]; // error: cannot borrow `v` as mutable
                  //           more than once at a time
```

Rust forbids this because if `i == j`, then `a` and `b` would be two `mut` references to the same integer, in violation of Rust's safety rules. (See [“Sharing Versus Mutation” on page 114](#).)

Rust has several methods that can borrow `mut` references to two or more parts of an array, slice, or vector at once. Unlike the code above, these methods are safe, because by design, they split the data into *nonoverlapping* regions. Many of these methods are also handy for working with non-`mut` slices, so there are `mut` and non-`mut` versions of each.

[Figure 16-2](#) illustrates these methods. None of them directly modify an array, slice, or vector; they merely return new references to parts of the data inside.

- `slice.iter()` and `slice.iter_mut()` produce a reference to each element of slice. We covered them in [“Iteration” on page 364](#).
- `slice.split_at(index)` and `slice.split_at_mut(index)` break a slice in two, returning a pair. `slice.split_at(index)` is equivalent to `(&slice[..index], &slice[index..])`. These methods panic if `index` is out of bounds.
- `slice.split_first()` and `slice.split_first_mut()` also return a pair: a reference to the first element (`slice[0]`) and a slice reference to all the rest (`slice[1..]`).

The return type of `.split_first()` is `Option<(&T, &[T])>`; the result is `None` if slice is empty.

- `slice.split_last()` and `slice.split_last_mut()` are analogous but split off the last element rather than the first.

The return type of `.split_last()` is `Option<(&[T], &T)>`.

- `slice.split(is_sep)` and `slice.split_mut(is_sep)` split `slice` into one or more subslices, using the function or closure `is_sep` to figure out where to split. They return an iterator over the subslices.

As you consume the iterator, it calls `is_sep(&element)` for each element in the slice. If `is_sep(&element)` is true, the element is a separator. Separators are not included in any output subslice.

The output always contains at least one subslice, plus one per separator. Empty subslices are included whenever separators appear adjacent to each other or to the ends of `slice`.

- `slice.splitn(n, is_sep)` and `slice.splitn_mut(n, is_sep)` are the same, but they produce at most `n` subslices. After the first `n-1` slices are found, `is_sep` is not called again. The last subslice contains all the remaining elements.
- `slice.rsplitn(n, is_sep)` and `slice.rsplitn_mut(n, is_sep)` are just like `.splitn()` and `.splitn_mut()` except that the slice is scanned in reverse order. That is, these methods split on the *last* `n-1` separators in the slice, rather than the first, and the subslices are produced starting from the end.
- `slice.chunks(n)` and `slice.chunks_mut(n)` return an iterator over non-overlapping subslices of length `n`.

If `slice.len()` is not a multiple of `n`, then the last subslice will have a length less than `n`.

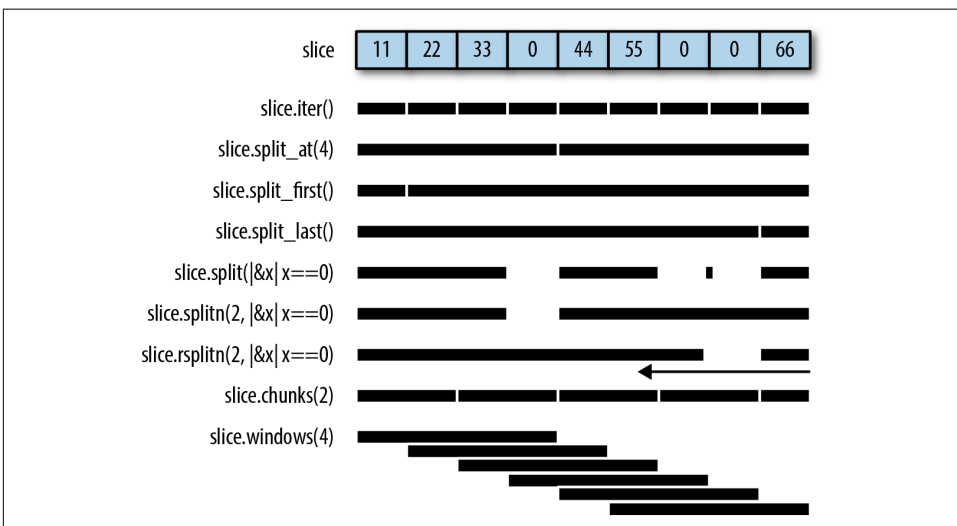

Figure 16-2. Splitting methods illustrated. The little rectangle in the output of `slice.split()` is an empty slice, caused by the two adjacent separators. Also note that `rsplitn` produces its output in end-to-start order, unlike all the others.

There's one more method for iterating over subslices:

- **slice.windows(n)** returns an iterator that behaves like a “sliding window” over the data in `slice`. It produces subslices that span `n` consecutive elements of `slice`. The first value produced is `&slice[0..n]`; the second is `&slice[1..n+1]`; and so on.

If `n` is greater than the length of `slice`, then no slices are produced. If `n` is 0, the method panics.

For example, if `days.len() == 31`, then we can produce all seven-day spans in `days` by calling `days.windows(7)`.

A sliding window of size 2 is handy for exploring how a data series changes from one data point to the next:

```
let changes = daily_high_temperatures
    .windows(2) // get adjacent days' temps
    .map(|w| w[1] - w[0]) // how much did it change?
    .collect::<Vec<_>>();
```

Because the subslices overlap, there is no variation of this method that returns `mut` references.

## Swapping

There's a convenience method for swapping two elements:

- **slice.swap(i, j)** swaps the two elements `slice[i]` and `slice[j]`.

Vectors have a related method for efficiently removing any element:

- **vec.swap\_remove(i)** removes and returns `vec[i]`. This is like `vec.remove(i)` except that instead of sliding the rest of the vector's elements over to close the gap, it simply moves `vec`'s last element into the gap. It's useful when you don't care about the order of the items left in the vector.

## Sorting and Searching

Slices offer three methods for sorting:

- **slice.sort()** sorts the elements into increasing order. This method is present only when the element type implements `Ord`.
- **slice.sort\_by(cmp)** sorts the elements of `slice` using a function or closure `cmp` to specify the sort order. `cmp` must implement `Fn(&T, &T) -> std::cmp::Ordering`.



Hand-implementing `cmp` is a pain, unless you delegate to a `.cmp()` method:

```
students.sort_by(|a, b| a.last_name.cmp(&b.last_name));
```

To sort by one field, using a second field as a tiebreaker, compare tuples:

```
students.sort_by(|a, b| {  
    let a_key = (&a.last_name, &a.first_name);  
    let b_key = (&b.last_name, &b.first_name);  
    a_key.cmp(&b_key)  
});
```

- **`slice.sort_by_key(key)`** sorts the elements of `slice` into increasing order by a sort key, given by the function or closure `key`. The type of `key` must implement `Fn(&T) -> K` where `K: Ord`.

This is useful when `T` contains one or more ordered fields, so that it could be sorted multiple ways.

```
// Sort by grade point average, lowest first.  
students.sort_by_key(|s| s.grade_point_average());
```

Note that these sort-key values are not cached during sorting, so the key function may be called more than  $n$  times.

For technical reasons, `key(element)` can't return any references borrowed from the element. This won't work:

```
students.sort_by_key(|s| &s.last_name); // error: can't infer lifetime
```

Rust can't figure out the lifetimes. But in these cases, it's easy enough to fall back on `.sort_by()`.

All three methods perform a stable sort.

To sort in reverse order, you can use `sort_by` with a `cmp` closure that swaps the two arguments. Taking arguments `|b, a|` rather than `|a, b|` effectively produces the opposite order. Or, you can just call the `.reverse()` method after sorting:

- **`slice.reverse()`** reverses a slice in place.

Once a slice is sorted, it can be efficiently searched:

- **`slice.binary_search(&value)`**, **`slice.binary_search_by(&value, cmp)`**, and **`slice.binary_search_by_key(&value, key)`** all search for `value` in the given sorted `slice`. Note that `value` is passed by reference.

The return type of these methods is `Result<usize, usize>`. They return `Ok(index)` if `slice[index]` equals `value` under the specified sort order. If there

is no such index, then they return `Err(insertion_point)` such that inserting value at `insertion_point` would preserve the order.

Of course, a binary search only works if the slice is in fact sorted in the specified order. Otherwise, the results are arbitrary—garbage in, garbage out.

Since `f32` and `f64` have NaN values, they do not implement `Ord`, and can't be used directly as keys with the sorting and binary search methods. To get similar methods that work on floating-point data, use the `ord_subset` crate.

There's one method for searching a vector that is not sorted:

- **`slice.contains(&value)`** returns `true` if any element of `slice` is equal to `value`. This simply checks each element of the slice until a match is found. Again, `value` is passed by reference.

To find the location of a value in a slice, like `array.indexOf(value)` in JavaScript, use an iterator:

```
slice.iter().position(|x| *x == value)
```

This returns an `Option<usize>`.

## Comparing Slices

If a type `T` supports the `==` and `!=` operators (the `PartialEq` trait, described in “Equality Tests” on page 272), then arrays `[T; N]`, slices `[T]`, and vectors `Vec<T>` support them too. Two slices are equal if they're the same length and their corresponding elements are equal. The same goes for arrays and vectors.

If `T` supports the operators `<`, `<=`, `>`, and `>=` (the `PartialOrd` trait, described in “Ordered Comparisons” on page 275), then arrays, slices, and vectors of `T` do too. Slice comparisons are lexicographical.

Two convenience methods perform common slice comparisons:

- **`slice.starts_with(other)`** returns `true` if `slice` starts with a sequence of values that are equal to the elements of the slice `other`:

```
assert_eq!([1, 2, 3, 4].starts_with(&[1, 2]), true);  
assert_eq!([1, 2, 3, 4].starts_with(&[2, 3]), false);
```

- **`slice.ends_with(other)`** is similar but checks the end of `slice`:

```
assert_eq!([1, 2, 3, 4].ends_with(&[3, 4]), true);
```

## Random Elements

Random numbers are not built into the Rust standard library. The `rand` crate, which provides them, offers these two methods for getting random output from an array, slice, or vector:

- `rng.choose(slice)` returns a reference to a random element of a slice. Like `slice.first()` and `slice.last()`, this returns an `Option<T>` that is `None` only if the slice is empty.
- `rng.shuffle(slice)` randomly reorders the elements of a slice in place. The slice must be passed by `mut` reference.

These are methods of the `rand::Rng` trait, so you need a `Rng`, a random number generator, in order to call them. Fortunately it's easy to get one by calling `rand::thread_rng()`. To shuffle the vector `my_vec`, we can write:

```
use rand::{Rng, thread_rng};

thread_rng().shuffle(&mut my_vec);
```

## Rust Rules Out Invalidation Errors

Most mainstream programming languages have collections and iterators, and they all have some variation on this rule: don't modify a collection while you're iterating over it. For example, the Python equivalent of a vector is a list:

```
my_list = [1, 3, 5, 7, 9]
```

Suppose we try to remove all values greater than 4 from `my_list`:

```
for index, val in enumerate(my_list):
    if val > 4:
        del my_list[index] # bug: modifying list while iterating

print(my_list)
```

(The `enumerate` function is Python's equivalent of Rust's `.enumerate()` method, described in [“enumerate” on page 341](#).)

This program, surprisingly, prints `[1, 3, 7]`. But seven is greater than four. How did that slip through? This is an invalidation error: the program modifies data while iterating over it, *invalidating* the iterator. In Java, the result would be an exception; in C++, undefined behavior. In Python, while the behavior is well-defined, it's unintuitive: the iterator skips an element. `val` is never 7.

Let's try to reproduce this bug in Rust:

```
fn main() {
    let mut my_vec = vec![1, 3, 5, 7, 9];
```

```

    for (index, &val) in my_vec.iter().enumerate() {
        if val > 4 {
            my_vec.remove(index); // error: can't borrow `my_vec` as mutable
        }
    }
    println!("{:?}", my_vec);
}

```

Naturally, Rust rejects this program at compile time. When we call `my_vec.iter()`, it borrows a shared (non-mut) reference to the vector. The reference lives as long as the iterator, to the end of the `for` loop. We can't modify the vector by calling `my_vec.remove(index)` while a non-mut reference exists.

Having an error pointed out to you is nice, but of course, you still need to find a way to get the desired behavior! The easiest fix here is to write:

```
my_vec.retain(|&val| val <= 4);
```

Or, you can do what you'd do in Python or any other language: create a new vector using a filter.

## VecDeque<T>

`Vec` supports efficiently adding and removing elements only at the end. When a program needs a place to store values that are “waiting in line,” `Vec` can be slow.

Rust's `std::collections::VecDeque<T>` is a *deque* (pronounced “deck”), a double-ended queue. It supports efficient add and remove operations at both the front and the back.

- `deque.push_front(value)` adds a value at the front of the queue.
- `deque.push_back(value)` adds a value at the end. (This method is used much more than `.push_front()`, because the usual convention for queues is that values are added at the back and removed at the front, like people waiting in a line.)
- `deque.pop_front()` removes and returns the front value of the queue, returning an `Option<T>` that is `None` if the queue is empty, like `vec.pop()`.
- `deque.pop_back()` removes and returns the value at the back, again returning an `Option<T>`.
- `deque.front()` and `deque.back()` work like `vec.first()` and `vec.last()`. They return a reference to the front or back element of the queue. The return value is an `Option<&T>` that is `None` if the queue is empty.
- `deque.front_mut()` and `deque.back_mut()` work like `vec.first_mut()` and `vec.last_mut()`, returning `Option<&mut T>`.

The implementation of `VecDeque` is a ring buffer, as shown in [Figure 16-3](#).

Like a `Vec`, it has a single heap allocation where elements are stored. Unlike `Vec`, the data does not always start at the beginning of this region, and it can “wrap around” the end, as shown. The elements of this deque, in order, are `['A', 'B', 'C', 'D', 'E']`. `VecDeque` has private fields, labeled `start` and `stop` in the figure, that it uses to remember where in the buffer the data begins and ends.

Adding a value to the queue, on either end, means claiming one of the unused slots, shown in dark gray, wrapping around or allocating a bigger chunk of memory if needed.

`VecDeque` manages wrapping, so you don’t have to think about it. [Figure 16-3](#) is a behind-the-scenes view of how Rust makes `.pop_front()` fast.

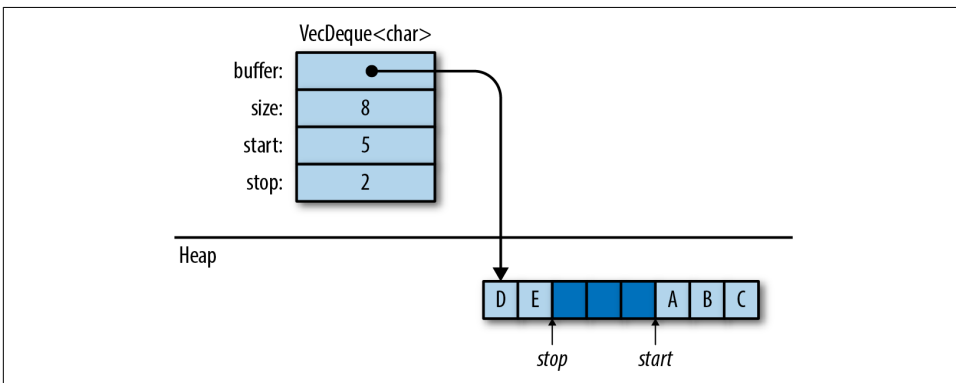

*Figure 16-3. How a `VecDeque` is stored in memory*

Often, when you need a deque, `.push_back()` and `.pop_front()` are the only two methods you need. The static methods `VecDeque::new()` and `VecDeque::with_capacity(n)`, for creating queues, are just like their counterparts in `Vec`. Many `Vec` methods are also implemented for `VecDeque`: `.len()` and `.is_empty()`, `.insert(index, value)` and `.remove(index)`, `.extend(iterable)`, and so on.

Deques, like vectors, can be iterated by value, by shared reference, or by `mut` reference. They have the three iterator methods `.into_iter()`, `.iter()`, and `.iter_mut()`. They can be indexed in the usual way: `deque[index]`.

However, because deques don’t store their elements contiguously in memory, they don’t inherit all the methods of slices. One way to perform vector and slice operations on deque data is to convert the `VecDeque` to a `Vec`, do the operation, and then change it back:

- `Vec<T>` implements `From<VecDeque<T>>`, so `Vec::from(deque)` turns a deque into a vector. This costs  $O(n)$  time, since it may require rearranging the elements.
- `VecDeque<T>` implements `From<Vec<T>>`, so `VecDeque::from(vec)` turns a vector into a deque. This is also  $O(n)$ , but it's usually fast, even if the vector is large, because the vector's heap allocation can simply be moved to the new deque.

This method makes it easy to create a deque with specified elements, even though there is no standard `vec_deque![]` macro:

```
use std::collections::VecDeque;

let v = VecDeque::from(vec![1, 2, 3, 4]);
```

## LinkedList<T>

A *linked list* is another way to store a sequence of values. Each value is stored in a separate heap allocation, as shown in [Figure 16-4](#).

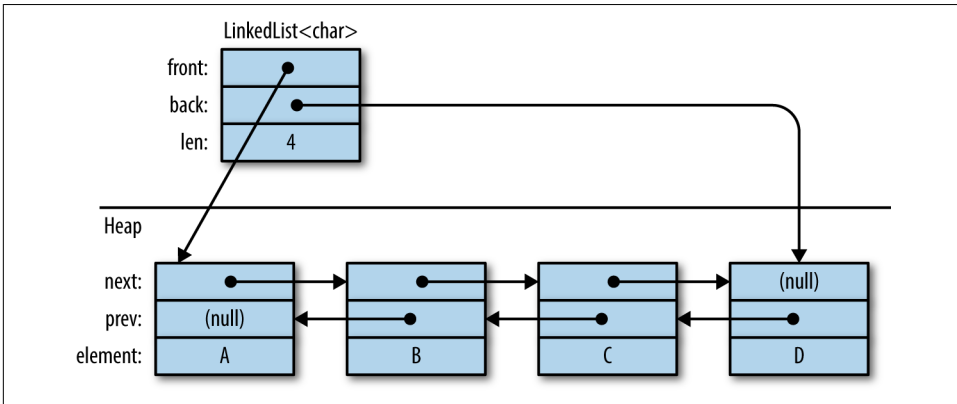

Figure 16-4. A `LinkedList<char>` in memory

`std::collections::LinkedList<T>` is a doubly linked list for Rust. It supports a subset of `VecDeque`'s methods. The methods that operate on the front and back of the sequence are all there; so are iterator methods, `LinkedList::new()`, and a few others. Methods that access elements by index, though, are generally omitted, since it's inherently inefficient to access linked list elements by index.

As of Rust 1.17, Rust's `LinkedList` type has no methods for removing a range of elements from a list or inserting elements at specific locations in a list. The API seems incomplete.

For now, the main advantage of `LinkedList` over `VecDeque` is that combining two lists is very fast. `list.append(&mut list2)`, the method that moves all elements from one list to another, only involves changing a few pointers, which can be done in constant time. The `append` methods of `Vec` and `VecDeque` sometimes have to move many values from one heap array to another.

## BinaryHeap<T>

A `BinaryHeap` is a collection whose elements are kept loosely organized so that the greatest value always bubbles up to the front of the queue. Here are the three most commonly used `BinaryHeap` methods:

- `heap.push(value)` adds a value to the heap.
- `heap.pop()` removes and returns the greatest value from the heap. It returns an `Option<T>` that is `None` if the heap was empty.
- `heap.peek()` returns a reference to the greatest value in the heap. The return type is `Option<&T>`.

`BinaryHeap` also supports a subset of the methods on `Vec`, including `BinaryHeap::new()`, `.len()`, `.is_empty()`, `.capacity()`, `.clear()`, and `.append(&mut heap2)`.

For example, if we populate a `BinaryHeap` with a bunch of numbers:

```
use std::collections::BinaryHeap;

let mut heap = BinaryHeap::from(vec![2, 3, 8, 6, 9, 5, 4]);
```

then the value 9 is at the top of the heap:

```
assert_eq!(heap.peek(), Some(&9));
assert_eq!(heap.pop(), Some(9));
```

Removing the value 9 also rearranges the other elements slightly so that 8 is now at the front, and so on:

```
assert_eq!(heap.pop(), Some(8));
assert_eq!(heap.pop(), Some(6));
assert_eq!(heap.pop(), Some(5));
...
```

Of course, `BinaryHeap` is not limited to numbers. It can hold any type of value that implements the `Ord` built-in trait.

This makes `BinaryHeap` useful as a work queue. You can define a task struct that implements `Ord` on the basis of priority, so that higher-priority tasks are `Greater` than lower-priority tasks. Then, create a `BinaryHeap` to hold all pending tasks. Its `.pop()`

method will always return the most important item, the task your program should work on next.

Note: `BinaryHeap` is iterable, and it has an `.iter()` method, but the iterators produce the heap's elements in an arbitrary order, not from greatest to least. To consume values from a `BinaryHeap` in order of priority, use a `while` loop:

```
while let Some(task) = heap.pop() {
    handle(task);
}
```

## HashMap<K, V> and BTreeMap<K, V>

A *map* is a collection of key-value pairs (called *entries*). No two entries have the same key, and the entries are kept organized so that if you have a key, you can efficiently look up the corresponding value in a map. In short, a map is a lookup table.

Rust offers two map types: `HashMap<K, V>` and `BTreeMap<K, V>`. The two share many of the same methods; the difference is in how the two keep entries arranged for fast lookup.

A `HashMap` stores the keys and values in a hash table, so it requires a key type `K` that implements `Hash` and `Eq`, the standard traits for hashing and equality.

Figure 16-5 shows how a `HashMap` is arranged in memory. Dark gray regions are unused. All keys, values, and cached hash codes are stored in a single heap-allocated table. Adding entries eventually forces the `HashMap` to allocate a larger table and move all the data into it.

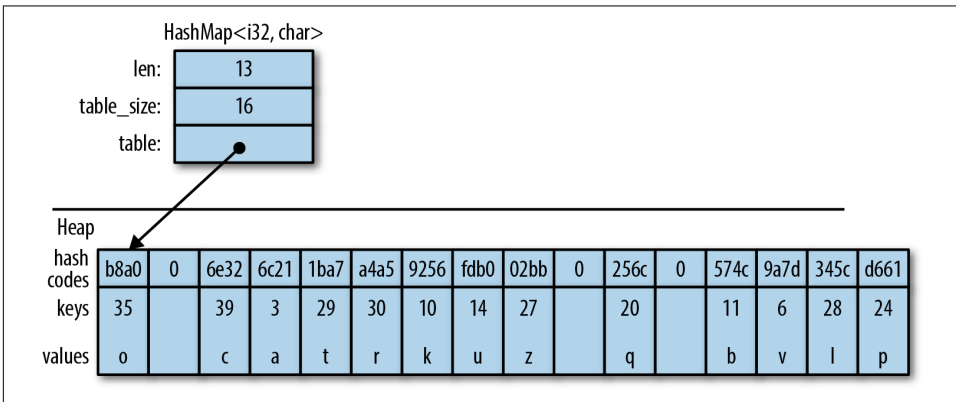

Figure 16-5. A `HashMap` in memory



A `BTreeMap` stores the entries in order by key, in a tree structure, so it requires a key type `K` that implements `Ord`. [Figure 16-6](#) shows a `BTreeMap`. Again, dark gray regions are unused spare capacity.

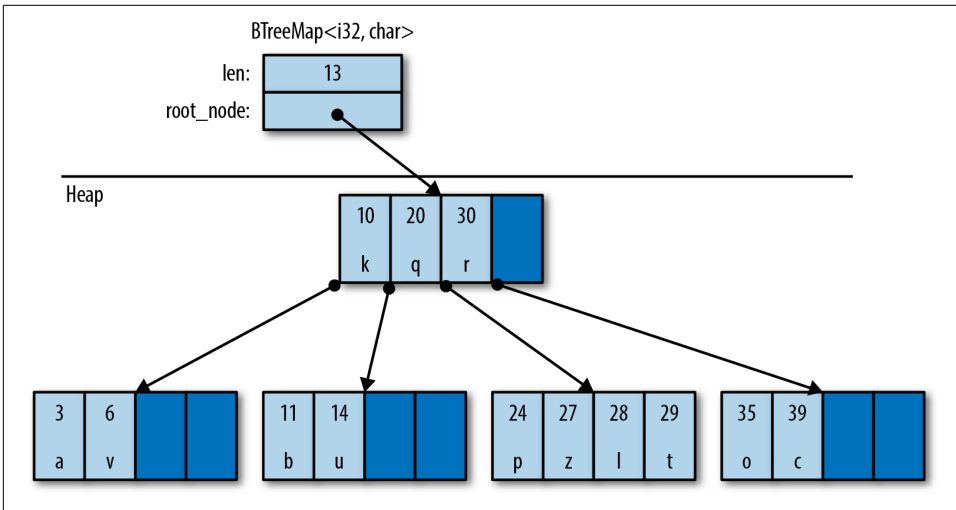

Figure 16-6. A `BTreeMap` in memory

A `BTreeMap` stores its entries in *nodes*. Most nodes in a `BTreeMap` contain only key-value pairs. Nonleaf nodes, like the root node shown in this figure, also have room for pointers to child nodes. The pointer between (20, 'q') and (30, 'r') points to a child node containing keys between 20 and 30. Adding entries often requires sliding some of a node's existing entries to the right, to keep them sorted, and occasionally involves allocating new nodes.

This picture is a bit simplified to fit on the page. For example, real `BTreeMap` nodes have room for 11 entries, not 4.

The Rust standard library uses B-trees rather than balanced binary trees because B-trees are faster on modern hardware. A binary tree may use fewer comparisons per search than a B-tree, but searching a B-tree has better *locality*—that is, the memory accesses are grouped together rather than scattered across the whole heap. This makes CPU cache misses rarer. It's a significant speed boost.

There are several ways to create a map:

- `HashMap::new()` and `BTreeMap::new()` create new, empty maps.
- `iter.collect()` can be used to create and populate a new `HashMap` or `BTreeMap` from key-value pairs. `iter` must be an `Iterator<Item=(K, V)>`.

- **HashMap::with\_capacity(n)** creates a new, empty hash map with room for at least *n* entries. HashMaps, like vectors, store their data in a single heap allocation, so they have a capacity and the related methods `hash_map.capacity()`, `hash_map.reserve(additional)`, and `hash_map.shrink_to_fit()`. BTreeMaps do not.

HashMaps and BTreeMaps have the same core methods for working with keys and values:

- **map.len()** returns the number of entries.
- **map.is\_empty()** returns true if `map` has no entries.
- **map.contains\_key(&key)** returns true if the map has an entry for the given key.
- **map.get(&key)** searches `map` for an entry with the given key. If a matching entry is found, this returns `Some(r)`, where *r* is a reference to the corresponding value. Otherwise, this returns `None`.

- **map.get\_mut(&key)** is similar, but it returns a `mut` reference to the value.

In general, maps let you have `mut` access to the values stored inside them, but not the keys. The values are yours to modify however you like. The keys belong to the map itself; it needs to ensure that they don't change, because the entries are organized by their keys. Modifying a key in-place would be a bug.

- **map.insert(key, value)** inserts the entry (`key`, `value`) into `map`. If there's already an entry for `key` in the map, the newly inserted `value` overwrites the old one.

Returns the old value, if any. The return type is `Option<V>`.

- **map.extend(iterable)** iterates over the (*K*, *V*) items of `iterable` and inserts each of those key-value pairs into `map`.
- **map.append(&mut map2)** moves all entries from `map2` into `map`. Afterward, `map2` is empty.
- **map.remove(&key)** finds and removes any entry with the given key from `map`.

Returns the removed value, if any. The return type is `Option<V>`.

- **map.clear()** removes all entries.

A map can also be queried using square brackets: `map[&key]`. That is, maps implement the `Index` built-in trait. However, this panics if there is not already an entry for the given key, like an out-of-bounds array access, so use this syntax only if the entry you're looking up is sure to be populated.

The key argument to `.contains_key()`, `.get()`, `.get_mut()`, and `.remove()` does not have to have the exact type `&K`. These methods are generic over types that can be borrowed from `K`. It's OK to call `fish_map.contains_key("conger")` on a `HashMap<String, Fish>`, even though "conger" isn't exactly a `String`, because `String` implements `Borrow<&str>`. For details, see [“Borrow and BorrowMut” on page 296](#).

Because a `BTreeMap<K, V>` keeps its entries sorted by key, it supports an additional operation:

- `btree_map.split_at(&key)` splits `btree_map` in two. Entries with keys less than `key` are left in `btree_map`. Returns a new `BTreeMap<K, V>` containing the other entries.

## Entries

Both `HashMap` and `BTreeMap` have a corresponding `Entry` type. The point of entries is to eliminate redundant map lookups. For example, here's some code to get or create a student record:

```
// Do we already have a record for this student?
if !student_map.contains_key(name) {
    // No: create one.
    student_map.insert(name.to_string(), Student::new());
}
// Now a record definitely exists.
let record = student_map.get_mut(name).unwrap();
...
```

This works fine, but it accesses `student_map` two or three times, doing the same lookup each time.

The idea with entries is that we do the lookup just once, producing an `Entry` value that is then used for all subsequent operations. This one-liner is equivalent to all the code above, except that it only does the lookup once:

```
let record = student_map.entry(name.to_string()).or_insert_with(Student::new);
```

The `Entry` value returned by `student_map.entry(name.to_string())` acts like a mutable reference to a place within the map that's either *occupied* by a key-value pair, or *vacant*, meaning there's no entry there yet. If vacant, the entry's `.or_insert_with()` method inserts a new `Student`. Most uses of entries are like this: short and sweet.

All Entry values are created by the same method:

- **map.entry(key)** returns an Entry for the given key. If there's no such key in the map, this returns a vacant Entry.

This method takes its `self` argument by `mut` reference and returns an Entry with a matching lifetime:

```
pub fn entry<'a>(&'a mut self, key: K) -> Entry<'a, K, V>
```

The Entry type has a lifetime parameter `'a` because it's effectively a fancy kind of borrowed `mut` reference to the map. As long as the Entry exists, it has exclusive access to the map.

Back in “Structs Containing References” on page 109, we saw how to store references in a type, and how that affects lifetimes. Now we're seeing what that looks like from a user's perspective. That's what's going on with Entry.

Unfortunately, it is not possible to pass a reference of type `&str` to this method if the map has `String` keys. The `.entry()` method, in that case, requires a real `String`.

Entry values provide two methods for filling in vacant entries:

- **map.entry(key).or\_insert(value)** ensures that `map` contains an entry with the given key, inserting a new entry with the given default `value` if needed. It returns a `mut` reference to the new or existing value.

Suppose we need to count votes. We can write:

```
let mut vote_counts: HashMap<String, usize> = HashMap::new();
for name in ballots {
    let count = vote_counts.entry(name).or_insert(0);
    *count += 1;
}
```

`.or_insert()` returns a `mut` reference, so the type of `count` is `&mut usize`.

- **map.entry(key).or\_insert\_with(default\_fn)** is the same, except that if it needs to create a new entry, it calls `default_fn()` to produce the default value. If there's already an entry for `key` in the `map`, then `default_fn` is not used.

Suppose we want to know which words appear in which files. We can write:

```
// This map contains, for each word, the set of files it appears in.
let mut word_occurrence: HashMap<String, HashSet<String>> =
    HashMap::new();
for file in files {
    for word in read_words(file)? {
        let set = word_occurrence
            .entry(word)
```

```

        .or_insert_with(HashSet::new);
    set.insert(file.clone());
    }
}

```

The `Entry` type is an enum, defined like this for `HashMap` (and similarly for `BTreeMap`):

```

// (in std::collections::hash_map)
pub enum Entry<'a, K: 'a, V: 'a> {
    Occupied(OccupiedEntry<'a, K, V>),
    Vacant(VacantEntry<'a, K, V>)
}

```

The `OccupiedEntry` and `VacantEntry` types have methods for inserting, removing, and accessing entries without repeating the initial lookup. You can find them in the online documentation. The extra methods can occasionally be used to eliminate a redundant lookup or two, but `.or_insert()` and `.or_insert_with()` cover the common cases.

## Map Iteration

There are several ways to iterate over a map:

- Iterating by value (“for (k, v) in map”) produces (K, V) pairs. This consumes the map.
- Iterating over a shared reference (“for (k, v) in &map”) produces (&K, &V) pairs.
- Iterating over a mut reference (“for (k, v) in &mut map”) produces (&K, &mut V) pairs. (Again, there’s no way to get mut access to keys stored in a map, because the entries are organized by their keys.)

Like vectors, maps have `.iter()` and `.iter_mut()` methods which return by-reference iterators, just like iterating over `&map` or `&mut map`. In addition:

- `map.keys()` returns an iterator over just the keys, by reference.
- `map.values()` returns an iterator over the values, by reference.
- `map.values_mut()` returns an iterator over the values, by mut reference.

All `HashMap` iterators visit the map’s entries in an arbitrary order. `BTreeMap` iterators visit them in order by key.

## HashSet<T> and BTreeSet<T>

Sets are collections of values arranged for fast membership testing.

```
let b1 = large_vector.contains("needle"); // slow, checks every element
let b2 = large_hash_set.contains("needle"); // fast, hash lookup
```

A set never contains multiple copies of the same value.

Maps and sets have different methods, but behind the scenes, a set is like a map with only keys, rather than key-value pairs. In fact, Rust's two set types, `HashSet<T>` and `BTreeSet<T>`, are implemented as thin wrappers around `HashMap<T, ()>` and `BTreeMap<T, ()>`.

- `HashSet::new()` and `BTreeSet::new()` create new sets.
- `iter.collect()` can be used to create a new set from any iterator. If `iter` produces any values more than once, the duplicates are dropped.
- `HashSet::with_capacity(n)` creates an empty `HashSet` with room for at least `n` values.

`HashSet<T>` and `BTreeSet<T>` have all the basic methods in common:

- `set.len()` returns the number of values in `set`.
- `set.is_empty()` returns `true` if the set contains no elements.
- `set.contains(&value)` returns `true` if the set contains the given `value`.
- `set.insert(value)` adds a `value` to the set. Returns `true` if a `value` was added, `false` if it was already a member of the set.
- `set.remove(&value)` removes a `value` from the set. Returns `true` if a `value` was removed, `false` if it already wasn't a member of the set.

As with maps, the methods that look up a value by reference are generic over types that can be borrowed from `T`. For details, see [“Borrow and BorrowMut” on page 296](#).

## Set Iteration

There are two ways to iterate over sets:

- Iterating by value (“`for v in set`”) produces the members of the set (and consumes the set).
- Iterating by shared reference (“`for v in &set`”) produces shared references to the members of the set.

Iterating over a set by `mut` reference is not supported. There's no way to get a `mut` reference to a value stored in a set.

- `set.iter()` returns an iterator over the members of `set` by reference.

`HashSet` iterators, like `HashMap` iterators, produce their values in an arbitrary order. `BTreeSet` iterators produce values in order, like a sorted vector.

## When Equal Values Are Different

Sets have a few odd methods that you need to use only if you care about differences between “equal” values.

Such differences do often exist. Two identical `String` values, for example, store their characters in different locations in memory:

```
let s1 = "hello".to_string();
let s2 = "hello".to_string();
println!("{:p}", &s1 as &str); // 0x7f8b32060008
println!("{:p}", &s2 as &str); // 0x7f8b32060010
```

Usually, we don't care.

But in case you ever do, you can get access to the actual values stored inside a set by using the following methods. Each one returns an `Option` that's `None` if `set` did not contain a matching value.

- `set.get(&value)` returns a shared reference to the member of `set` that's equal to `value`, if any. Returns an `Option<T>`.
- `set.take(&value)` is like `set.remove(&value)`, but it returns the removed value, if any. Returns an `Option<T>`.
- `set.replace(value)` is like `set.insert(value)`, but if `set` already contains a value that's equal to `value`, this replaces and returns the old value. Returns an `Option<T>`.

## Whole-Set Operations

So far, most of the set methods we've seen are focused on a single value in a single set. Sets also have methods that operate on whole sets.

- `set1.intersection(&set2)` returns an iterator over all values that are in both `set1` and `set2`.

For example, if we want to print the names of all students who are taking both brain surgery and rocket science classes, we could write:

```

for student in brain_class {
    if rocket_class.contains(&student) {
        println!("{}", student);
    }
}

```

Or, shorter:

```

for student in brain_class.intersection(&rocket_class) {
    println!("{}", student);
}

```

Amazingly, there's an operator for this.

**&set1 & &set2** returns a new set that's the intersection of **set1** and **set2**. This is the binary bitwise AND operator, applied to two references. This finds values that are in both **set1** AND **set2**.

```
let overachievers = &brain_class & &rocket_class;
```

- **set1.union(&set2)** returns an iterator over values that are in either **set1** or **set2**, or both.

**&set1 | &set2** returns a new set containing all those values. It finds values that are in either **set1** OR **set2**.

- **set1.difference(&set2)** returns an iterator over values that are in **set1** but not in **set2**.

**&set1 - &set2** returns a new set containing all those values.

- **set1.symmetric\_difference(&set2)** returns an iterator over values that are in either **set1** or **set2**, but not both.

**&set1 ^ &set2** returns a new set containing all those values.

And there are three methods for testing relationships between sets:

- **set1.is\_disjoint(set2)** is true if **set1** and **set2** have no values in common—the intersection between them is empty.
- **set1.is\_subset(set2)** is true if **set1** is a subset of **set2**—that is, all values in **set1** are also in **set2**.
- **set1.is\_superset(set2)** is the reverse: it's true if **set1** is a superset of **set2**.

Sets also support equality testing with **==** and **!=**; two sets are equal if they contain the same values.



# Hashing

`std::hash::Hash` is the standard library trait for hashable types. `HashMap` keys and `HashSet` elements must implement both `Hash` and `Eq`.

Most built-in types that implement `Eq` also implement `Hash`. The integer types, `char`, and `String` are all hashable; so are tuples, arrays, slices, and vectors, as long as their elements are hashable.

One principle of the standard library is that a value should have the same hash code regardless of where you store it or how you point to it. Therefore, a reference has the same hash code as the value it refers to, and a `Box` has the same hash code as the boxed value. A vector `vec` has the same hash code as the slice containing all its data, `&vec[..]`. A `String` has the same hash code as a `&str` with the same characters.

Structs and enums don't implement `Hash` by default, but an implementation can be derived:

```
/// The ID number for an object in the British Museum's collection.
#[derive(Clone, PartialEq, Eq, Hash)]
enum MuseumNumber {
    ...
}
```

This works as long as the type's fields are all hashable.

If you implement `PartialEq` by hand for a type, you should also implement `Hash` by hand. For example, suppose we have a type that represents priceless historical treasures:

```
struct Artifact {
    id: MuseumNumber,
    name: String,
    cultures: Vec<Culture>,
    date: RoughTime,
    ...
}
```

Two `Artifact`s are considered equal if they have the same ID:

```
impl PartialEq for Artifact {
    fn eq(&self, other: &Artifact) -> bool {
        self.id == other.id
    }
}

impl Eq for Artifact {}
```

Since we compare artifacts purely on the basis of their ID, we must hash them the same way:

```

impl Hash for Artifact {
    fn hash<H: Hasher>(&self, hasher: &mut H) {
        // Delegate hashing to the MuseumNumber.
        self.id.hash(hasher);
    }
}

```

(Otherwise, `HashSet<Artifact>` would not work properly; like all hash tables, it requires that `hash(a) == hash(b)` if `a == b`.)

This allows us to create a `HashSet` of `Artifact`s:

```

let mut collection = HashSet::<Artifact>::new();

```

As this code shows, even when you implement `Hash` by hand, you don't need to know anything about hashing algorithms. `.hash()` receives a reference to a `Hasher`, which represents the hashing algorithm. You simply feed this `Hasher` all the data that's relevant to the `==` operator. The `Hasher` computes a hash code from whatever you give it.

## Using a Custom Hashing Algorithm

The `hash` method is generic, so the `Hash` implementations shown above can feed data to any type that implements `Hasher`. This is how Rust supports pluggable hashing algorithms. `Hash` and `Hasher` are buddy traits, as explained in [“Buddy Traits \(or How `rand::random\(\)` Works\)” on page 258](#).

A third trait, `std::hash::BuildHasher`, is the trait for types that represent the initial state of a hashing algorithm. Each `Hasher` is single-use, like an iterator: you use it once and throw it away. A `BuildHasher` is reusable.

Every `HashMap` contains a `BuildHasher` that it uses each time it needs to compute a hash code. The `BuildHasher` value contains the key, initial state, or other parameters that the hashing algorithm needs every time it runs.

The complete protocol for computing a hash code looks like this:

```

use std::hash::{Hash, Hasher, BuildHasher};

fn compute_hash<B, T>(builder: &B, value: &T) -> u64
    where B: BuildHasher, T: Hash
{
    let mut hasher = builder.build_hasher(); // 1. start the algorithm
    value.hash(&mut hasher);                // 2. feed it data
    hasher.finish()                          // 3. finish, producing a u64
}

```

`HashMap` calls these three methods every time it needs to compute a hash code. All the methods are inlineable, so it's very fast.

Rust's default hashing algorithm is a well-known algorithm called SipHash-1-3. SipHash is fast, and it's very good at minimizing hash collisions. In fact, it's a cryptographic algorithm: there's no known efficient way to generate SipHash-1-3 collisions. As long as a different, unpredictable key is used for each hash table, Rust is secure against a kind of denial-of-service attack called HashDoS, where attackers deliberately use hash collisions to trigger worst-case performance in a server.

But perhaps you don't need that for your application. If you're storing many small keys, such as integers or very short strings, it is possible to implement a faster hash function, at the expense of HashDoS security. The `fnv` crate implements one such algorithm, the Fowler-Noll-Vo hash. To try it out, add this line to your `Cargo.toml`:

```
[dependencies]
fnv = "1.0"
```

Then import the map and set types from `fnv`:

```
extern crate fnv;

use fnv::{FnvHashMap, FnvHashSet};
```

You can use these two types as drop-in replacements for `HashMap` and `HashSet`. A peek inside the `fnv` source code reveals how they're defined:

```
/// A `HashMap` using a default FNV hasher.
pub type FnvHashMap<K, V> = HashMap<K, V, FnvBuildHasher>;

/// A `HashSet` using a default FNV hasher.
pub type FnvHashSet<T> = HashSet<T, FnvBuildHasher>;
```

The standard `HashMap` and `HashSet` collections accept an optional extra type parameter specifying the hashing algorithm; `FnvHashMap` and `FnvHashSet` are generic type aliases for `HashMap` and `HashSet`, specifying an FNV hasher for that parameter.

## Beyond the Standard Collections

Creating a new, custom collection type in Rust is much the same as in any other language. You arrange data by combining the parts the language provides: structs and enums, standard collections, `Options`, `Boxes`, and so on. For an example, see the `BinaryTree<T>` type defined in “[Generic Enums](#)” on page 218.

If you're used to implementing data structures in C++, using raw pointers, manual memory management, placement `new`, and explicit destructor calls to get the best possible performance, you'll undoubtedly find safe Rust rather limiting. All of those tools are inherently unsafe. They are available in Rust, but only if you opt in to unsafe code. [Chapter 21](#) shows how; it includes an example that uses some unsafe code to implement a safe custom collection.

For now, we'll just bask in the warm glow of the standard collections and their safe, efficient APIs. Like much of the Rust standard library, they're designed to ensure that the need to write "unsafe" is as rare as possible.

---

# Strings and Text

*The string is a stark data structure and everywhere it is passed there is much duplication of process. It is a perfect vehicle for hiding information.*

— Alan Perlis, epigram #34

We’ve been using Rust’s main textual types, `String`, `str`, and `char`, throughout the book. In [“String Types” on page 64](#), we described the syntax for character and string literals, and showed how strings are represented in memory. In this chapter, we cover text handling in more detail.

In this chapter:

- We give you some background on Unicode that should help you make sense of the standard library’s design.
- We describe the `char` type, representing a single Unicode code point.
- We describe the `String` and `str` types, representing owned and borrowed sequences of Unicode characters. These have a broad variety of methods for building, searching, modifying, and iterating over their contents.
- We cover Rust’s string formatting facilities, like the `println!` and `format!` macros. You can write your own macros that work with formatting strings, and extend them to support your own types.
- We give an overview of Rust’s regular expression support.
- Finally, we talk about why Unicode normalization matters, and show how to do it in Rust.

# Some Unicode Background

This book is about Rust, not Unicode, which has entire books devoted to it already. But Rust's character and string types are designed around Unicode. Here are a few bits of Unicode that help explain Rust.

## ASCII, Latin-1, and Unicode

Unicode and ASCII match for all of ASCII's code points, from 0 to 0x7f: for example, both assign the character '\*' the code point 42. Similarly, Unicode assigns 0 through 0xff to the same characters as the ISO/IEC 8859-1 character set, an eight-bit superset of ASCII for use with Western European languages. Unicode calls this range of code points *the Latin-1 code block*, so we'll refer to ISO/IEC 8859-1 by the more evocative name *Latin-1*.

Since Unicode is a superset of Latin-1, converting Latin-1 to Unicode doesn't even require a table:

```
fn latin1_to_char(latin1: u8) -> char {  
    latin1 as char  
}
```

The reverse conversion is trivial as well, assuming the code points fall in the Latin-1 range:

```
fn char_to_latin1(c: char) -> Option<u8> {  
    if c as u32 <= 0xff {  
        Some(c as u8)  
    } else {  
        None  
    }  
}
```

## UTF-8

The Rust `String` and `str` types represent text using the UTF-8 encoding form. UTF-8 encodes a character as a sequence of one to four bytes (Figure 17-1).

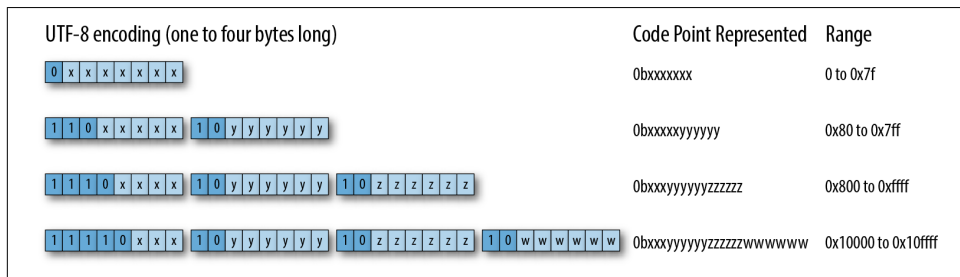

Figure 17-1. The UTF-8 encoding

There are two restrictions on well-formed UTF-8 sequences. First, only the shortest encoding for any given code point is considered well-formed; you can't spend four bytes encoding a code point that would fit in three. This rule ensures that there is exactly one UTF-8 encoding for a given code point. Second, well-formed UTF-8 must not encode numbers from 0xd800 through 0xdfff or beyond 0x10ffff: those are either reserved for noncharacter purposes, or outside Unicode's range entirely.

Figure 17-2 shows some examples.

UTF-8 encoding (one to four bytes long)	Code Point Represented	Range
0 0 1 0 1 0 1 0	0b0101010 == 0x2a	'*' (ASCII)
1 1 0 0 1 1 1 0 1 0 1 1 1 1 0 0	0b01110_111100 == 0x3bc	'µ' (ASCII)
1 1 1 0 1 0 0 1 1 0 0 0 1 1 1 0 0 1 0 0 0 0 1 1 1 0	0b1001_001100_000110 == 0x9306	'寂' (sabi: rust)
1 1 1 1 0 0 0 0 1 0 0 1 1 1 1 1 1 0 1 0 0 1 1 1 0 1 0 0 0 0 0 0 0 0	0b000_011111_100110_000000 == 0x1f980	'🦀' (crab emoji)

Figure 17-2. UTF-8 examples

Note that, even though the crab emoji has an encoding whose leading byte contributes only zeros to the code point, it still needs a four-byte encoding: three-byte UTF-8 encodings can only convey 16-bit code points, and 0x1f980 is 17 bits long.

Here's a quick example of a string containing characters with encodings of varying lengths:

```
assert_eq!("うどん: udon".as_bytes(),
    &[0xe3, 0x81, 0x86, // う
      0xe3, 0x81, 0xa9, // ど
      0xe3, 0x82, 0x93, // ん
      0x3a, 0x20, 0x75, 0x64, 0x6f, 0x6e // : udon
    ]);
```

The diagram shows some very helpful properties of UTF-8:

- Since UTF-8 encodes code points 0 through 0x7f as nothing more than the bytes 0 through 0x7f, a range of bytes holding ASCII text is valid UTF-8. And if a string of UTF-8 includes only characters from ASCII, the reverse is also true: the UTF-8 encoding is valid ASCII.

The same is not true for Latin-1: for example, Latin-1 encodes 'é' as the byte 0xe9, which UTF-8 would interpret as the first byte of a three-byte encoding.

- From looking at any byte's upper bits, you can immediately tell whether it is the start of some character's UTF-8 encoding, or a byte from the midst of one.

- An encoding's first byte alone tells you the encoding's full length, via its leading bits.
- Since no encoding is longer than four bytes, UTF-8 processing never requires unbounded loops, which is nice when working with untrusted data.
- In well-formed UTF-8, you can always tell unambiguously where characters' encodings begin and end, even if you start from a random point in the midst of the bytes. UTF-8 first bytes and following bytes are always distinct, so one encoding cannot start in the midst of another. The first byte determines the encoding's total length, so no encoding can be a prefix of another. This has a lot of nice consequences. For example, searching a UTF-8 string for an ASCII delimiter character requires only a simple scan for the delimiter's byte. It can never appear as any part of a multibyte encoding, so there's no need to keep track of the UTF-8 structure at all. Similarly, algorithms that search for one byte string in another will work without modification on UTF-8 strings, even though some don't even examine every byte of the text being searched.

Although variable-width encodings are more complicated than fixed-width encodings, these characteristics make UTF-8 more comfortable to work with than you might expect. The standard library handles most aspects for you.

## Text Directionality

Whereas scripts like Latin, Cyrillic, and Thai are written from left to right, other scripts like Hebrew and Arabic are written from right to left. Unicode stores characters in the order in which they would normally be written or read, so the initial bytes of a string holding, say, Hebrew text encode the character that would be written at the right:

```
assert_eq!("ערב טוב".chars().next(), Some('ע'));
```

A few method names in the standard library use the terms `left` and `right` to mean the start and end of the text. When we describe such functions, we'll spell out what they actually do.

## Characters (`char`)

A Rust `char` is a 32-bit value holding a Unicode code point. A `char` is guaranteed to fall in the range from `0` to `0xd7ff`, or in the range `0xe000` to `0x10ffff`; all the methods for creating and manipulating `char` values ensure that this is true. The `char` type implements `Copy` and `Clone`, along with all the usual traits for comparison, hashing, and formatting.

In the descriptions that follow, the variable `ch` is always of type `char`.



## Classifying Characters

The `char` type has methods for classifying characters into a few common categories. These all draw their definitions from Unicode, as shown in [Table 17-0](#).

Method	Description	Examples
<code>ch.is_numeric()</code>	A numeric character. This includes the Unicode general categories “Number; digit” and “Number; letter”, but not “Number; other”.	<code>'4'.is_numeric()</code> <code>'↑'.is_numeric()</code> <code>!'@'.is_numeric()</code>
<code>ch.is_alphabetic()</code>	An alphabetic character: Unicode’s “Alphabetic” derived property.	<code>'q'.is_alphabetic()</code> <code>'七'.is_alphabetic()</code>
<code>ch.is_alphanumeric()</code>	Either numeric or alphabetic, as defined above.	<code>'9'.is_alphanumeric()</code> <code>'饅'.is_alphanumeric()</code> <code>!'*.is_alphanumeric()</code>
<code>ch.is_whitespace()</code>	A whitespace character: Unicode character property “WSpace=Y”.	<code>' '.is_whitespace()</code> <code>'\n'.is_whitespace()</code> <code>'\u{A0}'.is_whitespace()</code>
<code>ch.is_control()</code>	A control character: Unicode’s “Other, control” general category.	<code>'\n'.is_control()</code> <code>'\u{85}'.is_control()</code>

## Handling Digits

For handling digits, you can use the following methods:

- **`ch.to_digit(radix)`** decides whether `ch` is a digit in base `radix`. If it is, it returns `Some(num)`, where `num` is a `u32`. Otherwise, it returns `None`. This recognizes only ASCII digits, not the broader class of characters covered by `char::is_numeric`. The `radix` parameter can range from 2 to 36. For radices larger than 10, ASCII letters of either case are considered digits with values from 10 through 35.
- The free function **`std::char::from_digit(num, radix)`** converts the `u32` digit value `num` to a `char` if possible. If `num` can be represented as a single digit in `radix`, `from_digit` returns `Some(ch)`, where `ch` is the digit. When `radix` is greater than 10, `ch` may be a lowercase letter. Otherwise, it returns `None`.

This is the reverse of `to_digit`. If `std::char::from_digit(num, radix)` is `Some(ch)`, then `ch.to_digit(radix)` is `Some(num)`. If `ch` is an ASCII digit or lowercase letter, the converse holds as well.

- **`ch.is_digit(radix)`** returns `true` if `ch` is an ASCII digit in base `radix`. This is equivalent to `ch.to_digit(radix) != None`.

So, for example:

```
assert_eq!('F'.to_digit(16), Some(15));
assert_eq!(std::char::from_digit(15, 16), Some('f'));
assert!(char::is_digit('f', 16));
```

## Case Conversion for Characters

For handling character case:

- `ch.is_lowercase()` and `ch.is_uppercase()` indicate whether `ch` is a lower- or uppercase alphabetic character. These follow Unicode’s Lowercase and Uppercase derived properties, so they cover non-Latin alphabets like Greek and Cyrillic, and give the expected results for ASCII as well.
- `ch.to_lowercase()` and `ch.to_uppercase()` return iterators that produce the characters of the lower- and uppercase equivalents of `ch`, according to the Unicode Default Case Conversion algorithms:

```
let mut upper = 's'.to_uppercase();
assert_eq!(upper.next(), Some('S'));
assert_eq!(upper.next(), None);
```

These methods return an iterator instead of a single character because case conversion in Unicode isn’t always a one-to-one process:

```
// The uppercase form of the German letter "sharp S" is "SS":
let mut upper = 'ß'.to_uppercase();
assert_eq!(upper.next(), Some('S'));
assert_eq!(upper.next(), Some('S'));
assert_eq!(upper.next(), None);

// Unicode says to lowercase Turkish dotted capital 'İ' to 'i'
// followed by '\u{307}', COMBINING DOT ABOVE, so that a
// subsequent conversion back to uppercase preserves the dot.
let ch = 'İ'; // '\u{130}'
let mut lower = ch.to_lowercase();
assert_eq!(lower.next(), Some('i'));
assert_eq!(lower.next(), Some('\u{307}'));
assert_eq!(lower.next(), None);
```

As a convenience, these iterators implement the `std::fmt::Display` trait, so you can pass them directly to a `println!` or `write!` macro.

## Conversions to and from Integers

Rust’s `as` operator will convert a `char` to any integer type, silently masking off any upper bits:

```
assert_eq!('B' as u32, 66);
assert_eq!('𨮩' as u8, 66); // upper bits truncated
assert_eq!('二' as i8, -116); // same
```

The `as` operator will convert any `u8` value to a `char`, and `char` implements `From<u8>` as well, but wider integer types can represent invalid code points, so for those you must use `std::char::from_u32`, which returns `Option<char>`:

```
assert_eq!(char::from(66), 'B');
assert_eq!(std::char::from_u32(0x9942), Some('饅'));
assert_eq!(std::char::from_u32(0xd800), None); // reserved for UTF-16
```

## String and str

Rust's `String` and `str` types are guaranteed to hold only well-formed UTF-8. The library ensures this by restricting the ways you can create `String` and `str` values and the operations you can perform on them, such that the values are well-formed when introduced, and remain so as you work with them. All their methods protect this guarantee: no safe operation on them can introduce ill-formed UTF-8. This simplifies code that works with the text.

Rust places text-handling methods on either `str` and `String` depending on whether the method needs a resizable buffer, or is happy just using the text in place. Since `String` dereferences to `&str`, every method defined on `str` is directly available on `String` as well. This section presents methods from both types, grouped by rough function.

These methods index text by byte offsets, and measure its length in bytes, rather than characters. In practice, given the nature of Unicode, indexing by character is not as useful as it may seem, and byte offsets are faster and simpler. If you try to use a byte offset that lands in the midst of some character's UTF-8 encoding, the method panics, so you can't introduce ill-formed UTF-8 this way.

A `String` is implemented as a wrapper around a `Vec<u8>` that ensures the vector's contents are always well-formed UTF-8. Rust will never change `String` to use a more complicated representation, so you can assume that `String` shares `Vec`'s performance characteristics.

In these explanations, the following variables have the given types:

Variable	Presumed type
<code>string</code>	<code>String</code>
<code>slice</code>	<code>&amp;str</code> or something that dereferences to one, like <code>String</code> or <code>Rc&lt;String&gt;</code>
<code>ch</code>	<code>char</code>
<code>n</code>	<code>usize</code> , a length
<code>i, j</code>	<code>usize</code> , a byte offset
<code>range</code>	A range of <code>usize</code> byte offsets, either fully bounded like <code>i..j</code> , or partly bounded like <code>i..</code> , <code>..j</code> , or <code>..</code>
<code>pattern</code>	Any pattern type: <code>char</code> , <code>String</code> , <code>&amp;str</code> , <code>&amp;[char]</code> , or <code>FnMut(char) -&gt; bool</code>

We describe pattern types in “Patterns for Searching Text” on page 402.

## Creating String Values

There are a few common ways to create `String` values:

- `String::new()` returns a fresh, empty string. This has no heap-allocated buffer, but will allocate one as needed.
- `String::with_capacity(n)` returns a fresh, empty string with a buffer pre-allocated to hold at least `n` bytes. If you know the length of the string you’re building in advance, this constructor lets you get the buffer sized correctly from the start, instead of resizing the buffer as you build the string. The string will still grow its buffer as needed if its length exceeds `n` bytes. Like vectors, strings have `capacity`, `reserve`, and `shrink_to_fit` methods, but usually the default allocation logic is fine.
- `slice.to_string()` allocates a fresh `String` whose contents are a copy of `slice`. We’ve been using expressions like `"literal text".to_string()` throughout the book to make `Strings` from string literals.
- `iter.collect()` constructs a string by concatenating an iterator’s items, which can be `char`, `&str`, or `String` values. For example, to remove all spaces from a string, you can write:

```
let spacey = "man hat tan";
let spaceless: String =
    spacey.chars().filter(|c| !c.is_whitespace()).collect();
assert_eq!(spaceless, "manhattan");
```

Using `collect` this way takes advantage of `String`’s implementation of the `std::iter::FromIterator` trait.

- The `&str` type cannot implement `Clone`: the trait requires `clone` on a `&T` to return a `T` value, but `str` is unsized. However, `&str` does implement `ToOwned`, which lets the implementer specify its owned equivalent, so `slice.to_owned()` returns a copy of `slice` as a freshly allocated `String`.

## Simple Inspection

These methods get basic information from string slices:

- `slice.len()` is the length of `slice`, in bytes.
- `slice.is_empty()` is true if `slice.len() == 0`.
- `slice[range]` returns a slice borrowing the given portion of `slice`. Partially bounded and unbounded ranges are OK: For example:

```
let full = "bookkeeping";
assert_eq!(&full[..4], "book");
assert_eq!(&full[5..], "eeping");
assert_eq!(&full[2..4], "ok");
assert_eq!(full[..].len(), 11);
assert_eq!(full[5..].contains("boo"), false);
```

- You cannot index a string slice with a single position, like `slice[i]`. Fetching a single character at a given byte offset is a bit clumsy: you must produce a `chars` iterator over the slice, and ask it to parse one character’s UTF-8:

```
let parenthesized = "Rust (餠)";
assert_eq!(parenthesized[6..].chars().next(), Some('餠'));
```

However, you should rarely need to do this. Rust has much nicer ways to iterate over slices, which we describe in “Iterating over Text” on page 403.

- `slice.split_at(i)` returns a tuple of two shared slices borrowed from `slice`: the portion up to byte offset `i`, and the portion after it. In other words, this returns `(slice[..i], slice[i..])`.
- `slice.is_char_boundary(i)` is true if the byte offset `i` falls between character boundaries, and is thus suitable as an offset into `slice`.

Naturally, slices can be compared for equality, ordered, and hashed. Ordered comparison simply treats the string as a sequence of Unicode code points and compares them in lexicographic order.

## Appending and Inserting Text

The following methods add text to a `String`:

- `string.push(ch)` appends the character `ch` to the end `string`.
- `string.push_str(slice)` appends the full contents of `slice`.
- `string.extend(iter)` appends the items produced by the iterator `iter` to the string. The iterator can produce `char`, `str`, or `String` values. These are `String`’s implementations of `std::iter::Extend`:

```
let mut also_spaceless = "con".to_string();
also_spaceless.extend("tri but ion".split_whitespace());
assert_eq!(also_spaceless, "contribution");
```

- `string.insert(i, ch)` inserts the single character `ch` at byte offset `i` in `string`. This entails shifting over any characters after `i` to make room for `ch`, so building up a string this way can require time quadratic in the length of the string.
- `string.insert_str(i, slice)` does the same for `slice`, with the same performance caveat.

String implements `std::fmt::Write`, meaning that the `write!` and `writeln!` macros can append formatted text to Strings:

```
use std::fmt::Write;

let mut letter = String::new();
writeln!(letter, "Whose {} these are I think I know", "rutabagas");
writeln!(letter, "His house is in the village though;");
assert_eq!(letter, "Whose rutabagas these are I think I know\n\
    His house is in the village though;\n");
```

Since `write!` and `writeln!` are designed for writing to output streams, they return a `Result`, which Rust complains if you ignore. This code uses the `?` operator to handle it, but writing to a `String` is actually infallible, so in this case calling `.unwrap()` would be OK too.

Since `String` implements `Add<&str>` and `AddAssign<&str>`, you can write code like this:

```
let left = "partners".to_string();
let mut right = "crime".to_string();
assert_eq!(left + " in " + &right, "partners in crime");

right += " doesn't pay";
assert_eq!(right, "crime doesn't pay");
```

When applied to strings, the `+` operator takes its left operand by value, so it can actually reuse that `String` as the result of the addition. As a consequence, if the left operand's buffer is large enough to hold the result, no allocation is needed.

In an unfortunate lack of symmetry, the left operand of `+` cannot be a `&str`, so you cannot write:

```
let parenthetical = "(" + string + "');
```

You must instead write:

```
let parenthetical = "(" + string.to_string() + "');
```

However, this restriction does discourage building up strings from the end backward. This approach performs poorly because the text must be repeatedly shifted toward the end of the buffer.

Building strings from beginning to end by appending small pieces, however, is efficient. A `String` behaves the way a vector does, always at least doubling its buffer's size when it needs more capacity. As explained in [“Building Vectors Element by Element” on page 62](#), this keeps copying overhead proportional to the final size. Even so, using `String::with_capacity` to create strings with the right buffer size to begin with avoids resizing at all, and can reduce the number of calls to the heap allocator.

## Removing Text

String has a few methods for removing text (these do not affect the string's capacity; use `shrink_to_fit` if you need to free memory):

- **`string.clear()`** resets `string` to the empty string.
- **`string.truncate(n)`** discards all characters after the byte offset `n`, leaving `string` with a length of at most `n`. If `string` is shorter than `n` bytes, this has no effect.
- **`string.pop()`** removes the last character from `string`, if any, and returns it as an `Option<char>`.
- **`string.remove(i)`** removes the character at byte offset `i` from `string` and returns it, shifting any following characters toward the front. This takes time linear in the number of following characters.
- **`string.drain(range)`** returns an iterator over the given range of byte indices, and removes the characters once the iterator is dropped. Characters after the range are shifted toward the front:

```
let mut choco = "chocolate".to_string();
assert_eq!(choco.drain(3..6).collect:::<String>(), "col");
assert_eq!(choco, "choate");
```

If you just want to remove the range, you can just drop the iterator immediately, without drawing any items from it:

```
let mut winston = "Churchill".to_string();
winston.drain(2..6);
assert_eq!(winston, "Chill");
```

## Conventions for Searching and Iterating

Rust's standard library functions for searching text and iterating over text follow some naming conventions to make them easier to remember:

- Most operations process text from start to end, but operations with names starting with **`r`** work from end to start. For example, `rsplit` is the end-to-start version of `split`. In some cases changing direction can affect not only the order in which values are produced but also the values themselves. See the diagram in [Figure 17-3](#) for an example of this.
- Iterators with names ending in **`n`** limit themselves to a given number of matches.
- Iterators with names ending in **`_indices`** produce, together with their usual iteration values, the byte offsets in the slice at which they appear.

The standard library doesn't provide all combinations for every operation. For example, many operations don't need an `n` variant, as it's easy enough to simply end the iteration early.

## Patterns for Searching Text

When a standard library function needs to search, match, split, or trim text, it accepts several different types to represent what to look for:

```
let haystack = "One fine day, in the middle of the night";

assert_eq!(haystack.find(','), Some(12));
assert_eq!(haystack.find("night"), Some(35));
assert_eq!(haystack.find(char::is_whitespace), Some(3));
```

These types are called *patterns*, and most operations support them:

```
assert_eq!("## Elephants"
    .trim_left_matches(|ch: char| ch == '#' || ch.is_whitespace()),
    "Elephants");
```

The standard library supports four main kinds of patterns:

- A `char` as a pattern matches that character.
- A `String` or `&str` or `&&str` as a pattern matches a substring equal to the pattern.
- A `FnMut(char) -> bool` closure as a pattern matches a single character for which the closure returns true.
- A `&[char]` as a pattern (not a `&str`, but a slice of `char` values) matches any single character that appears in the list. Note that if you write out the list as an array literal, you may need to use an `as` expression to get the type right:

```
let code = "\t    function noodle() { ";
assert_eq!(code.trim_left_matches(&[' ', '\t'] as &[char]),
    "function noodle() { ");
// Shorter equivalent: &[' ', '\t'][..]
```

Otherwise, Rust will be confused by the fixed-size array type `&[char; 2]`, which is unfortunately not a pattern type.

In the library's own code, a pattern is any type that implements the `std::str::Pattern` trait. The details of `Pattern` are not yet stable, so you can't implement it for your own types in stable Rust, but the door is open to permit regular expressions and other sophisticated patterns in the future. Rust does guarantee that the pattern types supported now will continue to work in the future.



## Searching and Replacing

Rust has a few methods for searching for patterns in slices and possibly replacing them with new text:

- `slice.contains(pattern)` returns true if `slice` contains a match for `pattern`.
- `slice.starts_with(pattern)` and `slice.ends_with(pattern)` return true if `slice`'s initial or final text matches `pattern`:

```
assert!("2017".starts_with(char::is_numeric));
```

- `slice.find(pattern)` and `slice.rfind(pattern)` return `Some(i)` if `slice` contains a match for `pattern`, where `i` is the byte offset at which the pattern appears. The `find` method returns the first match, `rfind` the last:

```
let quip = "We also know there are known unknowns";
assert_eq!(quip.find("know"), Some(8));
assert_eq!(quip.rfind("know"), Some(31));
assert_eq!(quip.find("ya know"), None);
assert_eq!(quip.rfind(char::is_uppercase), Some(0));
```

- `slice.replace(pattern, replacement)` returns a new `String` formed by replacing all matches for `pattern` with `replacement`:

```
assert_eq!("The only thing we have to fear is fear itself"
    .replace("fear", "spin"),
    "The only thing we have to spin is spin itself");
```

```
assert_eq!("`Borrow` and `BorrowMut`"
    .replace(|ch:char| !ch.is_alphanumeric(), ""),
    "BorrowandBorrowMut");
```

- `slice.replacen(pattern, replacement, n)` does the same, but replaces at most the first `n` matches.

## Iterating over Text

The standard library provides several ways to iterate over a slice's text. [Figure 17-3](#) shows examples of some.

You can think of the `split` and `match` families as being complements of each other: splits are the ranges between matches.

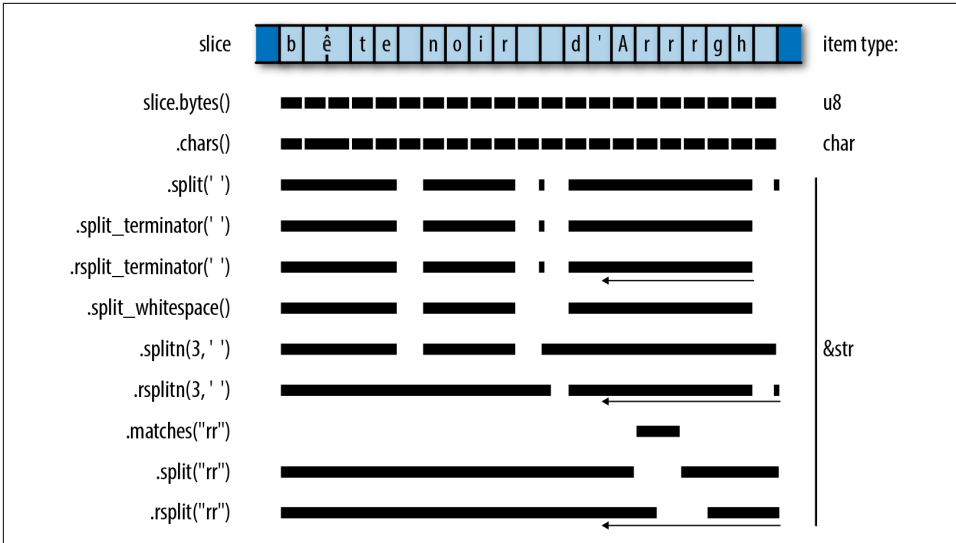

Figure 17-3. Some ways to iterate over a slice

For some kinds of patterns, working from end to start can change the values produced; for an example, see the splits on the pattern "rr" in the figure. Patterns that always match a single character can't behave this way. When an iterator would produce the same set of items in either direction (that is, when only the order is affected), the iterator is a `DoubleEndedIterator`, meaning that you can apply its `rev` method to iterate in the other order, and draw items from either end:

- `slice.chars()` returns an iterator over `slice`'s characters.
- `slice.char_indices()` returns an iterator over `slice`'s characters and their byte offsets:

```
assert_eq!("élan".char_indices().collect:::<Vec<_>>(),
          vec![(0, 'é'), // has a two-byte UTF-8 encoding
              (2, 'l'),
              (3, 'a'),
              (4, 'n')]);
```

Note that this is not equivalent to `.chars().enumerate()`, since it supplies each character's byte offset within the slice, instead of just numbering the characters.

- `slice.bytes()` returns an iterator over the individual bytes of `slice`, exposing the UTF-8 encoding:

```
assert_eq!("élan".bytes().collect:::<Vec<_>>(),
          vec![195, 169, b'l', b'a', b'n']);
```

- `slice.lines()` returns an iterator over the lines of `slice`. Lines are terminated by `"\n"` or `"\r\n"`. Each item produced is a `&str` borrowing from `slice`. The items do not include the lines' terminating characters.
- `slice.split(pattern)` returns an iterator over the portions of `slice` separated by matches of `pattern`. This produces empty strings between immediately adjacent matches, as well as for matches at the beginning and end of `slice`.
- The `slice.rsplit(pattern)` method is the same, but scans `slice` from end to start, producing matches in that order.
- `slice.split_terminator(pattern)` and `slice.rsplit_terminator(pattern)` are similar, except that the pattern is treated as a terminator, not a separator: if `pattern` matches at the right end of `slice`, the iterators do not produce an empty slice representing the empty string between that match and the end of the slice, as `split` and `rsplit` do. For example:

```
// The ':' characters are separators here. Note the final "".
assert_eq!("jimb:1000:Jim Blandy:".split(':').collect::<Vec<_>>(),
           vec!["jimb", "1000", "Jim Blandy", ""]);

// The '\n' characters are terminators here.
assert_eq!("127.0.0.1 localhost\n
127.0.0.1 www.reddit.com\n"
           .split_terminator('\n').collect::<Vec<_>>(),
           vec!["127.0.0.1 localhost",
                "127.0.0.1 www.reddit.com"]);
// Note, no final ""!
```

- The `slice.splitn(n, pattern)` and `slice.rsplitn(n, pattern)` are like `split` and `rsplit`, except that they split the string into at most `n` slices, at the first or last `n-1` matches for `pattern`.
- `slice.split_whitespace()` returns an iterator over the whitespace-separated portions of `slice`. A run of multiple whitespace characters is considered a single separator. Trailing whitespace is ignored. This uses the same definition of *whitespace* as `char::is_whitespace`:

```
let poem = "This is just to say\n
I have eaten\n
the plums\n
again\n";

assert_eq!(poem.split_whitespace().collect::<Vec<_>>(),
           vec!["This", "is", "just", "to", "say",
                "I", "have", "eaten", "the", "plums",
                "again"]);
```

- `slice.matches(pattern)` returns an iterator over the matches for `pattern` in `slice`. `slice.rmatches(pattern)` is the same, but iterates from end to start.

- `slice.match_indices(pattern)` and `slice.rmatch_indices(pattern)` are similar, except that the items produced are (offset, match) pairs, where offset is the byte offset at which the match begins, and match is the matching slice.

## Trimming

To *trim* a string is to remove text, usually whitespace, from the beginning or end of the string. It's often useful in cleaning up input read from a file where the user might have indented text for legibility, or accidentally left trailing whitespace on a line.

- `slice.trim()` returns a subslice of `slice` that omits any leading and trailing whitespace. `slice.trim_left()` omits only leading whitespace, `slice.trim_right()` only trailing whitespace:

```
assert_eq!("\t*.rs ".trim(), "*.rs");
assert_eq!("\t*.rs ".trim_left(), "*.rs ");
assert_eq!("\t*.rs ".trim_right(), "\t*.rs");
```

- `slice.trim_matches(pattern)` returns a subslice of `slice` that omits all matches of `pattern` from the beginning and end. The `trim_left_matches` and `trim_right_matches` methods do the same for only leading or trailing matches:

```
assert_eq!("001990".trim_left_matches('0'), "1990");
```

Note that the terms `left` and `right` in these methods' names always refer to the start and end of the slice, respectively, regardless of the directionality of the text they hold.

## Case Conversion for Strings

The methods `slice.to_uppercase()` and `slice.to_lowercase()` return a freshly allocated string holding the text of `slice` converted to uppercase or lowercase. The result may not be the same length as `slice`; see “[Case Conversion for Characters](#)” on [page 396](#) for details.

## Parsing Other Types from Strings

Rust provides standard traits for both parsing values from strings and producing textual representations of values.

If a type implements the `std::str::FromStr` trait, then it provides a standard way to parse a value from a string slice:

```
pub trait FromStr: Sized {
    type Err;
    fn from_str(s: &str) -> Result<Self, Self::Err>;
}
```

All the usual machine types implement `FromStr`:

```
use std::str::FromStr;

assert_eq!(usize::from_str("3628800"), Ok(3628800));
assert_eq!(f64::from_str("128.5625"), Ok(128.5625));
assert_eq!(bool::from_str("true"), Ok(true));

assert!(f64::from_str("not a float at all").is_err());
assert!(bool::from_str("TRUE").is_err());
```

The `std::net::IpAddr` type, an enum holding either an IPv4 or an IPv6 internet address, implements `FromStr` too:

```
use std::net::IpAddr;

let address = IpAddr::from_str("fe80::0000:3ea9:f4ff:fe34:7a50")?;
assert_eq!(address,
           IpAddr::from([0xfe80, 0, 0, 0, 0x3ea9, 0xf4ff, 0xfe34, 0x7a50]));
```

String slices have a `parse` method that parses the slice into whatever type you like, assuming it implements `FromStr`. As with `Iterator::collect`, you will sometimes need to spell out which type you want, so `parse` is not always much more legible than calling `from_str` directly:

```
let address = "fe80::0000:3ea9:f4ff:fe34:7a50".parse::<IpAddr>()?;
```

## Converting Other Types to Strings

There are three main ways to convert nontextual values to strings:

- Types that have a natural human-readable printed form can implement the `std::fmt::Display` trait, which lets you use the `{}` format specifier in the `format!` macro:

```
assert_eq!(format!("{}", wow, "doge"), "doge, wow");
assert_eq!(format!("{}", true), "true");
assert_eq!(format!("{:.3}, {:.3}", 0.5, f64::sqrt(3.0)/2.0),
           "(0.500, 0.866)");

// Using `address` from above.
let formatted_addr: String = format!("{}", address);
assert_eq!(formatted_addr, "fe80::3ea9:f4ff:fe34:7a50");
```

All Rust's machine numeric types implement `Display`, as do characters, strings, and slices. The smart pointer types `Box<T>`, `Rc<T>`, and `Arc<T>` implement `Display` if `T` itself does: their displayed form is simply that of their referent. Containers like `Vec` and `HashMap` do not implement `Display`, as there's no single natural human-readable form for those types.

- If a type implements `Display`, the standard library automatically implements the `std::str::ToString` trait for it, whose sole method `to_string` can be more convenient when you don't need the flexibility of `format!`:

```
// Continued from above.
assert_eq!(address.to_string(), "fe80::3ea9:f4ff:fe34:7a50");
```

The `ToString` trait predates the introduction of `Display` and is less flexible. For your own types, you should generally implement `Display` instead of `ToString`.

- Every public type in the standard library implements `std::fmt::Debug`, which takes a value and formats it as a string in a way helpful to programmers. The easiest way to use `Debug` to produce a string is via the `format!` macro's `{:?}` format specifier:

```
// Continued from above.
let addresses = vec![address,
                    IpAddr::from_str("192.168.0.1")?];
assert_eq!(format!("{:?}", addresses),
           "[V6(fe80::3ea9:f4ff:fe34:7a50), V4(192.168.0.1)]");
```

This takes advantage of a blanket implementation of `Debug` for `Vec<T>`, for any `T` that itself implements `Debug`. All of Rust's collection types have such implementations.

You should implement `Debug` for your own types, too. Usually it's best to let Rust derive an implementation, as we did for the `Complex` type earlier in the book:

```
#[derive(Copy, Clone, Debug)]
struct Complex { r: f64, i: f64 }
```

The `Display` and `Debug` formatting traits are just two among several that the `format!` macro and its relatives use to format values as text. We'll cover the others, and explain how to implement them all, in [“Formatting Values” on page 413](#).

## Borrowing as Other Text-Like Types

You can borrow a slice's contents in several different ways:

- Slices and strings implement `AsRef<str>`, `AsRef<[u8]>`, `AsRef<Path>`, and `AsRef<OsStr>`. Many standard library functions use these traits as bounds on their parameter types, so you can pass slices and strings to them directly, even when what they really want is some other type. See [“AsRef and AsMut” on page 294](#) for a more detailed explanation.
- Slices and strings also implement the `std::borrow::Borrow<str>` trait. `HashMap` and `BTreeMap` use `Borrow` to make strings work nicely as keys in a table, as do

functions like `[T>::binary_search`. See “[Borrow and BorrowMut](#)” on page 296 for details.

## Accessing Text as UTF-8

There are two main ways to get at the bytes representing text, depending on whether you want to take ownership of the bytes or just borrow them:

- `slice.as_bytes()` borrows `slice`’s bytes as a `&[u8]`. Since this is not a mutable reference, `slice` can assume its bytes will remain well-formed UTF-8.
- `string.into_bytes()` takes ownership of `string` and returns a `Vec<u8>` of the string’s bytes by value. This is a cheap conversion, as it simply hands over the `Vec<u8>` that the string had been using as its buffer. Since `string` no longer exists, there’s no need for the bytes to continue to be well-formed UTF-8, and the caller is free to modify the `Vec<u8>` as it pleases.

## Producing Text from UTF-8 Data

If you have a block of bytes that you believe contains UTF-8 data, you have a few options for converting them into `Strings` or slices, depending on how you want to handle errors:

- `str::from_utf8(byte_slice)` takes a `&[u8]` slice of bytes and returns a `Result`: either `Ok(&str)` if `byte_slice` contains well-formed UTF-8, or an error otherwise.
- `String::from_utf8(vec)` tries to construct a string from a `Vec<u8>` passed by value. If `vec` holds well-formed UTF-8, `from_utf8` returns `Ok(string)`, where `string` has taken ownership of `vec` for use as its buffer. No heap allocation or copying of the text takes place.

If the bytes are not valid UTF-8, this returns `Err(e)`, where `e` is a `FromUtf8Error` error value. The call `e.into_bytes()` gives you back the original vector `vec`, so it is not lost when the conversion fails:

```
let good_utf8: Vec<u8> = vec![0xe9, 0x8c, 0x86];
assert_eq!(String::from_utf8(good_utf8).ok(), Some("鏄".to_string()));

let bad_utf8: Vec<u8> = vec![0x9f, 0xf0, 0xa6, 0x80];
let result = String::from_utf8(bad_utf8);
assert!(result.is_err());
// Since String::from_utf8 failed, it didn't consume the original
// vector, and the error value hands it back to us unharmed.
```

```
assert_eq!(result.unwrap_err().into_bytes(),
           vec![0x9f, 0xf0, 0xa6, 0x80]);
```

- **String::from\_utf8\_lossy(byte\_slice)** tries to construct a `String` or `&str` from a `&[u8]` shared slice of bytes. This conversion always succeeds, replacing any ill-formed UTF-8 with Unicode replacement characters. The return value is a `Cow<str>` that either borrows a `&str` directly from `byte_slice` if it contains well-formed UTF-8, or owns a freshly allocated `String` with replacement characters substituted for the ill-formed bytes. Hence, when `byte_slice` is well-formed, no heap allocation or copying takes place. We discuss `Cow<str>` in more detail in [“Putting Off Allocation” on page 410](#).
- If you know for a fact that your `Vec<u8>` contains well-formed UTF-8, then you can call the unsafe function **String::from\_utf8\_unchecked**. This simply wraps the `Vec<u8>` up as a `String` and returns it, without examining the bytes at all. You are responsible for making sure you haven’t introduced ill-formed UTF-8 into the system, which is why this function is marked `unsafe`.
- Similarly, **str::from\_utf8\_unchecked** takes a `&[u8]` and returns it as a `&str`, without checking to see if it holds well-formed UTF-8. As with `String::from_utf8_unchecked`, you are responsible for making sure this is safe.

## Putting Off Allocation

Suppose you want your program to greet the user. On Unix, you could write:

```
fn get_name() -> String {
    std::env::var("USER") // Windows uses "USERNAME"
        .unwrap_or("whoever you are".to_string())
}

println!("Greetings, {}!", get_name());
```

For Unix users, this greets them by username. For Windows users and the tragically unnamed, it provides alternative stock text.

The `std::env::var` function returns a `String`—and has good reasons to do so that we won’t go into here. But that means the alternative stock text must also be returned as a `String`. This is disappointing: when `get_name` returns a static string, no allocation should be necessary at all.

The nub of the problem is that sometimes the return value of `name` should be an owned `String`, sometimes it should be a `&'static str`, and we can’t know which one it will be until we run the program. This dynamic character is the hint to consider using `std::borrow::Cow`, the clone-on-write type that can hold either owned or borrowed data.



As explained in “[Borrow and ToOwned at Work: The Humble Cow](#)” on page 300, `Cow<'a, T>` is an enum with two variants: `Owned` and `Borrowed`. `Borrowed` holds a reference `&'a T`, and `Owned` holds the owning version of `&T`: `String` for `&str`, `Vec<i32>` for `&[i32]`, and so on. Whether `Owned` or `Borrowed`, a `Cow<'a, T>` can always produce a `&T` for you to use. In fact, `Cow<'a, T>` dereferences to `&T`, behaving as a kind of smart pointer.

Changing `get_name` to return a `Cow` results in the following:

```
use std::borrow::Cow;

fn get_name() -> Cow<'static, str> {
    std::env::var("USER")
        .map(|v| Cow::Owned(v))
        .unwrap_or(Cow::Borrowed("whoever you are"))
}
```

If this succeeds in reading the "USER" environment variable, the `map` returns the resulting `String` as a `Cow::Owned`. If it fails, the `unwrap_or` returns its static `&str` as a `Cow::Borrowed`. The caller can remain unchanged:

```
println!("Greetings, {}!", get_name());
```

As long as `T` implements the `std::fmt::Display` trait, displaying a `Cow<'a, T>` produces the same results as displaying a `T`.

`Cow` is also useful when you may or may not need to modify some text you've borrowed. When no changes are necessary, you can continue to borrow it. But `Cow`'s namesake clone-on-write behavior can give you an owned, mutable copy of the value on demand. `Cow`'s `to_mut` method makes sure the `Cow` is `Cow::Owned`, applying the value's `ToOwned` implementation if necessary, and then returns a mutable reference to the value.

So if you find that some of your users, but not all, have titles by which they would prefer to be addressed, you can say:

```
fn get_title() -> Option<&'static str> { ... }

let mut name = get_name();
if let Some(title) = get_title() {
    name.to_mut().push_str(", ");
    name.to_mut().push_str(title);
}

println!("Greetings, {}!", name);
```

This might produce output like the following:

```
$ cargo run
Greetings, jimb, Esq.!
$
```

What's nice here is that, if `get_name()` returns a static string and `get_title` returns `None`, the `Cow` simply carries the static string all the way through to the `println!`. You've managed to put off allocation unless it's really necessary, while still writing straightforward code.

Since `Cow` is frequently used for strings, the standard library has some special support for `Cow<'a, str>`. It provides `From` and `Into` conversions from both `String` and `&str`, so you can write `get_name` more tersely:

```
fn get_name() -> Cow<'static, str> {
    std::env::var("USER")
        .map(|v| v.into())
        .unwrap_or("whoever you are".into())
}
```

`Cow<'a, str>` also implements `std::ops::Add` and `std::ops::AddAssign`, so to add the title to the name, you could write:

```
if let Some(title) = get_title() {
    name += ", ";
    name += title;
}
```

Or, since a `String` can be a `write!` macro's destination:

```
use std::fmt::Write;

if let Some(title) = get_title() {
    write!(name.to_mut(), ", {}", title).unwrap();
}
```

As before, no allocation occurs until you try to modify the `Cow`.

Keep in mind that not every `Cow<..., str>` must be `'static`: you can use `Cow` to borrow previously computed text until the moment a copy becomes necessary.

## Strings as Generic Collections

`String` implements both `std::default::Default` and `std::iter::Extend`: `default` returns an empty string, and `extend` can append characters, string slices, or strings to the end of a string. This is the same combination of traits implemented by Rust's other collection types like `Vec` and `HashMap` for generic construction patterns such as `collect` and `partition`.

The `&str` type also implements `Default`, returning an empty slice. This is handy in some corner cases; for example, it lets you derive `Default` for structures containing string slices.

# Formatting Values

Throughout the book, we've been using text formatting macros like `println!`:

```
println!("{:.3}µs: relocated {} at {:#x} to {:#x}, {} bytes",
         0.84391, "object",
         140737488346304_usize, 6299664_usize, 64);
```

That call produces the following output:

```
0.844µs: relocated object at 0x7fffffffddc0 to 0x602010, 64 bytes
```

The string literal serves as a template for the output: each `{...}` in the template gets replaced by the formatted form of one of the following arguments. The template string must be a constant, so that Rust can check it against the types of the arguments at compile time. Each argument must be used; Rust reports a compile-time error otherwise.

Several standard library features share this little language for formatting strings:

- The `format!` macro uses it to build `Strings`.
- The `println!` and `print!` macros write formatted text to the standard output stream.
- The `writeln!` and `write!` macros write it to a designated output stream.
- The `panic!` macro uses it to build a (hopefully informative) expression of terminal dismay.

Rust's formatting facilities are designed to be open-ended. You can extend these macros to support your own types by implementing the `std::fmt` module's formatting traits. And you can use the `format_args!` macro and the `std::fmt::Arguments` type to make your own functions and macros support the formatting language.

Formatting macros always borrow shared references to their arguments; they never take ownership of them or mutate them.

The template's `{...}` forms are called *format parameters*, and have the form `{which:how}`. Both parts are optional; `{}` is frequently used.

The *which* value selects which argument following the template should take the parameter's place. You can select arguments by index or by name. Parameters with no *which* value are simply paired with arguments from left to right.

The *how* value says how the argument should be formatted: how much padding, to which precision, in which numeric radix, and so on. If *how* is present, the colon before it is required.

Here are some examples:

Template string	Argument list	Result
"number of {}: {}"	"elephants", 19	"number of elephants: 19"
"from {1} to {0}"	"the grave", "the cradle"	"from the cradle to the grave"
"v = {:?}"	vec![0,1,2,5,12,29]	"v = [0, 1, 2, 5, 12, 29]"
"name = {:?}"	"Nemo"	"name = \"Nemo\""
"{:8.2} km/s"	11.186	" 11.19 km/s"
"{:20} {:02x} {:02x}"	"adc #42", 105, 42	"adc #42 69 2a"
"{:1:02x} {:2:02x} {0}"	"adc #42", 105, 42	"69 2a adc #42"
"{:lsb:02x} {:msb:02x} {insn}"	insn="adc #42", lsb=105, msb=42	"69 2a adc #42"

If you want to include '{' or '}' characters in your output, double the characters in the template:

```
assert_eq!(format!("{}", c) < format!("{}", b, c)),  
           "a, c < a, b, c");
```

## Formatting Text Values

When formatting a textual type like `&str` or `String` (`char` is treated like a single-character string), the *how* value of a parameter has several parts, all optional.

- A *text length limit*. Rust truncates your argument if it is longer than this. If you specify no limit, Rust uses the full text.
- A *minimum field width*. After any truncation, if your argument is shorter than this, Rust pads it on the right (by default) with spaces (by default) to make a field of this width. If omitted, Rust doesn't pad your argument.
- An *alignment*. If your argument needs to be padded to meet the minimum field width, this says where your text should be placed within the field. `<`, `^`, and `>` put your text at the start, middle, and end, respectively.
- A *padding* character to use in this padding process. If omitted, Rust uses spaces. If you specify the padding character, you must also specify the alignment.

Here are some examples showing how to write things out, and their effects. All are using the same eight-character argument, "bookends":

Features in use	Template string	Result
Default	"{}"	"bookends"
Minimum field width	"{:4}"	"bookends"
	"{:12}"	"bookends  "

Features in use	Template string	Result
Text length limit	"{: .4}"	"book"
	"{: .12}"	"bookends"
Field width, length limit	"{:12.20}"	"bookends "
	"{:4.20}"	"bookends"
	"{:4.6}"	"booken"
	"{:6.4}"	"book "
Aligned left, width	"{:<12}"	"bookends "
Centered, width	"{: ^12}"	" bookends "
Aligned right, width	"{: >12}"	" bookends"
Pad with '=', centered, width	"{: = ^12}"	"==bookends=="
Pad '*', aligned right, width, limit	"{: * >12.4}"	"*****book"

Rust's formatter has a naïve understanding of width: it assumes each character occupies one column, with no regard for combining characters, half-width katakana, zero-width spaces, or the other messy realities of Unicode. For example:

```
assert_eq!(format!("{:4}", "th\u{e9}"), "th\u{e9} ");
assert_eq!(format!("{:4}", "the\u{301}"), "the\u{301}");
```

Although Unicode says these strings are both equivalent to "thé", Rust's formatter doesn't know that characters like '\u{301}', COMBINING ACUTE ACCENT, need special treatment. It pads the first string correctly, but assumes the second is four columns wide and adds no padding. Although it's easy to see how Rust could improve in this specific case, true multilingual text formatting for all of Unicode's scripts is a monumental task, best handled by relying on your platform's user interface toolkits, or perhaps by generating HTML and CSS and making a web browser sort it all out.

Along with `&str` and `String`, you can also pass formatting macros smart pointer types with textual referents, like `Rc<String>` or `Cow<'a, str>`, without ceremony.

Since filename paths are not necessarily well-formed UTF-8, `std::path::Path` isn't quite a textual type; you can't pass a `std::path::Path` directly to a formatting macro. However, a `Path`'s `display` method returns a value you can format that sorts things out in a platform-appropriate way:

```
println!("processing file: {}", path.display());
```

## Formatting Numbers

When the formatting argument has a numeric type like `usize` or `f64`, the parameter's *how* value has the following parts, all optional:

- A *padding* and *alignment*, which work as they do with textual types.

- A `+` character, requesting that the number's sign always be shown, even when the argument is positive.
- A `#` character, requesting an explicit radix prefix like `0x` or `0b`. See the “notation” bullet point that concludes this list.
- A `0` character, requesting that the minimum field width be satisfied by including leading zeros in the number, instead of the usual padding approach.
- A *minimum field width*. If the formatted number is not at least this wide, Rust pads it on the left (by default) with spaces (by default) to make a field of the given width.
- A *precision* for floating-point arguments, indicating how many digits Rust should include after the decimal point. Rust rounds or zero-extends as necessary to produce exactly this many fractional digits. If the precision is omitted, Rust tries to accurately represent the value using as few digits as possible. For arguments of integer type, the precision is ignored.
- A *notation*. For integer types, this can be `b` for binary, `o` for octal, or `x` or `X` for hexadecimal with lower- or uppercase letters. If you included the `#` character, these include an explicit Rust-style radix prefix, `0b`, `0o`, `0x`, or `0X`. For floating-point types, a radix of `e` or `E` requests scientific notation, with a normalized coefficient, using `e` or `E` for the exponent. If you don't specify any notation, Rust formats numbers in decimal.

Some examples of formatting the `i32` value `1234`:

Features in use	Template string	Result
Default	<code>"{}"</code>	<code>"1234"</code>
Forced sign	<code>"{:+}"</code>	<code>"+1234"</code>
Minimum field width	<code>"{:12}"</code>	<code>"1234"</code>
	<code>"{:2}"</code>	<code>"1234"</code>
Sign, width	<code>"{:+12}"</code>	<code>"1234"</code>
Leading zeros, width	<code>"{:012}"</code>	<code>"000000001234"</code>
Sign, zeros, width	<code>"{:+012}"</code>	<code>"+000000001234"</code>
Aligned left, width	<code>"{:&lt;12}"</code>	<code>"1234"</code>
Centered, width	<code>"{: ^12}"</code>	<code>"1234"</code>
Aligned right, width	<code>"{:&gt;12}"</code>	<code>"1234"</code>
Aligned left, sign, width	<code>"{:&lt;+12}"</code>	<code>"1234"</code>
Centered, sign, width	<code>"{: ^+12}"</code>	<code>"1234"</code>
Aligned right, sign, width	<code>"{:&gt;+12}"</code>	<code>"1234"</code>
Padded with <code>'='</code> , centered, width	<code>"{: =^12}"</code>	<code>"====1234===="</code>
Binary notation	<code>"{:b}"</code>	<code>"10011010010"</code>
Width, octal notation	<code>"{:12o}"</code>	<code>"2322"</code>

Features in use	Template string	Result
Sign, width, hexadecimal notation	"{:+12x}"	" +4d2"
Sign, width, hex with capital digits	"{:+12X}"	" +4D2"
Sign, explicit radix prefix, width, hex	"{:+#12x}"	" +0x4d2"
Sign, radix, zeros, width, hex	"{:+#012x}"	" +0x0000004d2"
	"{:+#06x}"	" +0x4d2"

As the last two examples show, the minimum field width applies to the entire number, sign, radix prefix, and all.

Negative numbers always include their sign. The results are like those shown in the “forced sign” examples.

When you request leading zeros, alignment and padding characters are simply ignored, since the zeros expand the number to fill the entire field.

Using the argument `1234.5678`, we can show effects specific to floating-point types:

Features in use	Template string	Result
Default	"{}"	"1234.5678"
Precision	"{: .2}"	"1234.57"
	"{: .6}"	"1234.567800"
Minimum field width	"{:12}"	" 1234.5678"
Minimum, precision	"{:12.2}"	" 1234.57"
	"{:12.6}"	" 1234.567800"
Leading zeros, minimum, precision	"{:012.6}"	"01234.567800"
Scientific	"{:e}"	"1.2345678e3"
Scientific, precision	"{: .3e}"	"1.235e3"
Scientific, minimum, precision	"{:12.3e}"	" 1.235e3"
	"{:12.3E}"	" 1.235E3"

## Formatting Other Types

Beyond strings and numbers, you can format several other standard library types:

- Error types can all be formatted directly, making it easy to include them in error messages. Every error type should implement the `std::error::Error` trait, which extends the default formatting trait `std::fmt::Display`. As a consequence, any type that implements `Error` is ready to format.
- You can format internet protocol address types like `std::net::IpAddr` and `std::net::SocketAddr`.

- The Boolean `true` and `false` values can be formatted, although these are usually not the best strings to present directly to end users.

You should use the same sorts of format parameters that you would for strings. Length limit, field width, and alignment controls work as expected.

## Formatting Values for Debugging

To help with debugging and logging, the `{:?}` parameter formats any public type in the Rust standard library in a way meant to be helpful to programmers. You can use this to inspect vectors, slices, tuples, hash tables, threads, and hundreds of other types.

For example, you can write the following:

```
use std::collections::HashMap;
let mut map = HashMap::new();
map.insert("Portland", (45.5237606, -122.6819273));
map.insert("Taipei", (25.0375167, 121.5637));
println!("{:?}", map);
```

This prints:

```
{"Taipei": (25.0375167, 121.5637), "Portland": (45.5237606, -122.6819273)}
```

The `HashMap` and `(f64, f64)` types already know how to format themselves, with no effort required on your part.

If you include the `#` character in the format parameter, Rust will pretty-print the value. Changing this code to say `println!("{:#?}", map)` leads to this output:

```
{
  "Taipei": (
    25.0375167,
    121.5637
  ),
  "Portland": (
    45.5237606,
    -122.6819273
  )
}
```

These exact forms aren't guaranteed, and do sometimes change from one Rust release to the next.

As we've mentioned, you can use the `#[derive(Debug)]` syntax to make your own types work with `{:?}`:

```
#[derive(Copy, Clone, Debug)]
struct Complex { r: f64, i: f64 }
```

With this definition in place, we can use a `{:?}` format to print `Complex` values:



```
let third = Complex { r: -0.5, i: f64::sqrt(0.75) };
println!("{:?}", third);
```

This prints:

```
Complex { r: -0.5, i: 0.8660254037844386 }
```

This is fine for debugging, but it might be nice if `{}` could print them in a more traditional form, like `-0.5 + 0.8660254037844386i`. In [“Formatting Your Own Types” on page 421](#), we’ll show how to do exactly that.

## Formatting Pointers for Debugging

Normally, if you pass any sort of pointer to a formatting macro—a reference, a `Box`, an `Rc`—the macro simply follows the pointer and formats its referent; the pointer itself is not of interest. But when you’re debugging, it’s sometimes helpful to see the pointer: an address can serve as a rough “name” for an individual value, which can be illuminating when examining structures with cycles or sharing.

The `{:p}` notation formats references, boxes, and other pointer-like types as addresses:

```
use std::rc::Rc;
let original = Rc::new("mazurka".to_string());
let cloned = original.clone();
let impostor = Rc::new("mazurka".to_string());
println!("text:      {}, {}, {}", original, cloned, impostor);
println!("pointers: {:p}, {:p}, {:p}", original, cloned, impostor);
```

This code prints:

```
text:      mazurka, mazurka, mazurka
pointers: 0x7f99af80e000, 0x7f99af80e000, 0x7f99af80e030
```

Of course, the specific pointer values will vary from run to run, but even so, comparing the addresses makes it clear that the first two are references to the same `String`, whereas the third points to a distinct value.

Addresses do tend to look like hexadecimal soup, so more refined visualizations can be worthwhile, but the `{:p}` style can still be an effective quick-and-dirty solution.

## Referring to Arguments by Index or Name

A format parameter can explicitly select which argument it uses. For example:

```
assert_eq!(format!("{1},{0},{2}", "zeroth", "first", "second"),
           "first,zeroth,second");
```

You can include format parameters after a colon:

```
assert_eq!(format!("{2:#06x},{1:b},{0:=>10}", "first", 10, 100),
           "0x0064,1010,====first");
```

You can also select arguments by name. This makes complex templates with many parameters much more legible. For example:

```
assert_eq!(format!("{description:.<25}{quantity:2} @ {price:5.2}",
                  price=3.25,
                  quantity=3,
                  description="Maple Turmeric Latte"),
          "Maple Turmeric Latte..... 3 @ 3.25");
```

(The named arguments here resemble keyword arguments in Python, but this is just a special feature of the formatting macros, not part of Rust's function call syntax.)

You can mix indexed, named, and positional (that is, no index or name) parameters together in a single formatting macro use. The positional parameters are paired with arguments from left to right as if the indexed and named parameters weren't there:

```
assert_eq!(format!("{mode} {2} {} {}",
                  "people", "eater", "purple", mode="flying"),
          "flying purple people eater");
```

Named arguments must appear at the end of the list.

## Dynamic Widths and Precisions

A parameter's minimum field width, text length limit, and numeric precision need not always be fixed values; you can choose them at runtime.

We've been looking at cases like this expression, which gives you the string content right-justified in a field 20 characters wide:

```
format!("{:>20}", content)
```

But if you'd like to choose the field width at runtime, you can write:

```
format!("{:>1$}", content, get_width())
```

Writing `1$` for the minimum field width tells `format!` to use the value of the second argument as the width. The cited argument must be a `usize`. You can also refer to the argument by name:

```
format!("{:>width$}", content, width=get_width())
```

The same approach works for the text length limit as well:

```
format!("{:>width$.limit$}", content,
        width=get_width(), limit=get_limit())
```

In place of the text length limit or floating-point precision, you can also write `*`, which says to take the next positional argument as the precision. The following clips content to at most `get_limit()` characters:

```
format!("{:.*$}", get_limit(), content)
```

The argument taken as the precision must be a `usize`. There is no corresponding syntax for the field width.

## Formatting Your Own Types

The formatting macros use a set of traits defined in the `std::fmt` module to convert values to text. You can make Rust's formatting macros format your own types by implementing one or more of these traits yourself.

The notation of a format parameter indicates which trait its argument's type must implement:

Notation	Example	Trait	purpose
none	{}	<code>std::fmt::Display</code>	Text, numbers, errors: the catch-all trait
b	{bits:#b}	<code>std::fmt::Binary</code>	Numbers in binary
o	{:#5o}	<code>std::fmt::Octal</code>	Numbers in octal
x	{:4x}	<code>std::fmt::LowerHex</code>	Numbers in hexadecimal, lower-case digits
X	{:016X}	<code>std::fmt::UpperHex</code>	Numbers in hexadecimal, upper-case digits
e	{:.3e}	<code>std::fmt::LowerExp</code>	Floating-point numbers in scientific notation
E	{:.3E}	<code>std::fmt::UpperExp</code>	Same, upper-case E
?	{:#?}	<code>std::fmt::Debug</code>	Debugging view, for developers
p	{:p}	<code>std::fmt::Pointer</code>	Pointer as address, for developers

When you put the `#[derive(Debug)]` attribute on a type definition so that you can use the `{:#?}` format parameter, you are simply asking Rust to implement the `std::fmt::Debug` trait for you.

The formatting traits all have the same structure, differing only in their names. We'll use `std::fmt::Display` as a representative:

```
trait Display {
    fn fmt(&self, dest: &mut std::fmt::Formatter)
        -> std::fmt::Result;
}
```

The `fmt` method's job is to produce a properly formatted representation of `self` and write its characters to `dest`. In addition to serving as an output stream, the `dest` argument also carries details parsed from the format parameter, like the alignment and minimum field width.

For example, earlier in this chapter we suggested that it would be nice if `Complex` values printed themselves in the usual `a + bi` form. Here's a `Display` implementation that does that:

```
use std::fmt;
```

```

impl fmt::Display for Complex {
    fn fmt(&self, dest: &mut fmt::Formatter) -> fmt::Result {
        let i_sign = if self.i < 0.0 { '-' } else { '+' };
        write!(dest, "{} {} {}i", self.r, i_sign, f64::abs(self.i))
    }
}

```

This takes advantage of the fact that `Formatter` is itself an output stream, so the `write!` macro can do most of the work for us. With this implementation in place, we can write the following:

```

let one_twenty = Complex { r: -0.5, i: 0.866 };
assert_eq!(format!("{}", one_twenty),
           "-0.5 + 0.866i");

let two_forty = Complex { r: -0.5, i: -0.866 };
assert_eq!(format!("{}", two_forty),
           "-0.5 - 0.866i");

```

It's sometimes helpful to display complex numbers in polar form: if you imagine a line drawn on the complex plane from the origin to the number, the polar form gives the line's length, and its clockwise angle to the positive x-axis. The `#` character in a format parameter typically selects some alternate display form; the `Display` implementation could treat it as a request to use polar form:

```

impl fmt::Display for Complex {
    fn fmt(&self, dest: &mut fmt::Formatter) -> fmt::Result {
        let (r, i) = (self.r, self.i);
        if dest.alternate() {
            let abs = f64::sqrt(r * r + i * i);
            let angle = f64::atan2(i, r) / std::f64::consts::PI * 180.0;
            write!(dest, "{} ∠ {}°", abs, angle)
        } else {
            let i_sign = if i < 0.0 { '-' } else { '+' };
            write!(dest, "{} {} {}i", r, i_sign, f64::abs(i))
        }
    }
}

```

Using this implementation:

```

let ninety = Complex { r: 0.0, i: 2.0 };
assert_eq!(format!("{}", ninety),
           "0 + 2i");
assert_eq!(format!("{:#}", ninety),
           "2 ∠ 90°");

```

Although the formatting traits' `fmt` methods return a `fmt::Result` value (a typical module-specific `Result` type), you should propagate failures only from operations on the `Formatter`, as the `fmt::Display` implementation does with its calls to `write!`; your formatting functions must never originate errors themselves. This allows mac-

ros like `format!` to simply return a `String` instead of a `Result<String, ...>`, since appending the formatted text to a `String` never fails. It also ensures that any errors you do get from `write!` or `writeln!` reflect real problems from the underlying I/O stream, not formatting issues.

`Formatter` has plenty of other helpful methods, including some for handling structured data like maps, lists, and so on, which we won't cover here; consult the online documentation for the full details.

## Using the Formatting Language in Your Own Code

You can write your own functions and macros that accept format templates and arguments by using Rust's `format_args!` macro and the `std::fmt::Arguments` type. For example, suppose your program needs to log status messages as it runs, and you'd like to use Rust's text formatting language to produce them. The following would be a start:

```
fn logging_enabled() -> bool {
    ...
}

use std::fs::OpenOptions;
use std::io::Write;

fn write_log_entry(entry: std::fmt::Arguments) {
    if logging_enabled() {
        // Keep things simple for now, and just
        // open the file every time.
        let mut log_file = OpenOptions::new()
            .append(true)
            .create(true)
            .open("log-file-name")
            .expect("failed to open log file");

        log_file.write_fmt(entry)
            .expect("failed to write to log");
    }
}
```

You can call `write_log_entry` like so:

```
write_log_entry(format_args!("Hark! {:?}\n", mysterious_value));
```

At compile time, the `format_args!` macro parses the template string and checks it against the arguments' types, reporting an error if there are any problems. At runtime, it evaluates the arguments and builds an `Arguments` value carrying all the information necessary to format the text: a pre-parsed form of the template, along with shared references to the argument values.

Constructing an `Arguments` value is cheap: it's just gathering up some pointers. No formatting work takes place yet, only the collection of the information needed to do so later. This can be important: if logging is not enabled, any time spent converting numbers to decimal, padding values, and so on would be wasted.

The `File` type implements the `std::io::Write` trait, whose `write_fmt` method takes an `Argument` and does the formatting. It writes the results to the underlying stream.

That call to `write_log_entry` isn't pretty. This is where a macro can help:

```
macro_rules! log { // no ! needed after name in macro definitions
    ($format:tt, $($arg:expr),*) => (
        write_log_entry(format_args!($format, $($arg),*))
    )
}
```

We cover macros in detail in [Chapter 20](#). For now, take it on faith that this defines a new `log!` macro that passes its arguments along to `format_args!`, and then calls your `write_log_entry` function on the resulting `Arguments` value. The formatting macros like `println!`, `writeln!`, and `format!` are all roughly the same idea.

You can use `log!` like so:

```
log!("0 day and night, but this is wondrous strange! {:?}\n",
     mysterious_value);
```

Hopefully, this looks a little better.

## Regular Expressions

The external `regex` crate is Rust's official regular expression library. It provides the usual searching and matching functions. It has good support for Unicode, but it can search byte strings as well. Although it doesn't support some features you'll often find in other regular expression packages, like backreferences and look-around patterns, those simplifications allow `regex` to ensure that searches take time linear in the size of the expression and in the length of the text being searched. These guarantees, among others, make `regex` safe to use even with untrusted expressions searching untrusted text.

In this book, we'll provide only an overview of `regex`; you should consult its online documentation for details.

Although the `regex` crate is not in `std`, it is maintained by the Rust library team, the same group responsible for `std`. To use `regex`, put the following line in the `[dependencies]` section of your crate's `Cargo.toml` file:

```
regex = "0.2.2"
```

Then place an `extern crate` item in your crate's root:

```
extern crate regex;
```

In the following sections, we'll assume that you have these changes in place.

## Basic Regex Use

A `Regex` value represents a parsed regular expression, ready to use. The `Regex::new` constructor tries to parse a `&str` as a regular expression, and returns a `Result`:

```
use regex::Regex;

// A semver version number, like 0.2.1.
// May contain a pre-release version suffix, like 0.2.1-alpha.
// (No build metadata suffix, for brevity.)
//
// Note use of r"... " raw string syntax, to avoid backslash blizzard.
let semver = Regex::new(r"(\d+)\.(\d+)\.(\d+)(-[-.[:alnum:]]*)?");

// Simple search, with a Boolean result.
let haystack = r#"regex = "0.2.5"#"#;
assert!(semver.is_match(haystack));
```

The `Regex::captures` method searches a string for the first match, and returns a `regex::Captures` value holding match information for each group in the expression:

```
// You can retrieve capture groups:
let captures = semver.captures(haystack)
    .ok_or("semver regex should have matched");
assert_eq!(&captures[0], "0.2.5");
assert_eq!(&captures[1], "0");
assert_eq!(&captures[2], "2");
assert_eq!(&captures[3], "5");
```

Indexing a `Captures` value panics if the requested group didn't match. To test whether a particular group matched, you can call `Captures::get`, which returns an `Option<regex::Match>`. A `Match` value records a single group's match:

```
assert_eq!(captures.get(4), None);
assert_eq!(captures.get(3).unwrap().start(), 13);
assert_eq!(captures.get(3).unwrap().end(), 14);
assert_eq!(captures.get(3).unwrap().as_str(), "5");
```

You can iterate over all the matches in a string:

```
let haystack = "In the beginning, there was 1.0.0. \
    For a while, we used 1.0.1-beta, \
    but in the end, we settled on 1.2.4.";

let matches: Vec<&str> = semver.find_iter(haystack)
    .map(|match_| match_.as_str())
    .collect();
assert_eq!(matches, vec!["1.0.0", "1.0.1-beta", "1.2.4"]);
```

The `find_iter` iterator produces a `Match` value for each nonoverlapping match of the expression, working from the start of the string to the end. The `captures_iter` method is similar, but produces `Captures` values recording all capture groups. Searching is slower when capture groups must be reported, so if you don't need them, it's best to use one of the methods that doesn't return them.

## Building Regex Values Lazily

The `Regex::new` constructor can be expensive: constructing a `Regex` for a 1200-character regular expression can take almost a millisecond on a fast developer machine, and even a trivial expression takes microseconds. It's best to keep `Regex` construction out of heavy computational loops; instead, you should construct your `Regex` once, and then reuse the same one.

The `lazy_static` crate provides a nice way to construct static values lazily the first time they are used. To start with, note the dependency in your `Cargo.toml` file:

```
[dependencies]
lazy_static = "0.2.8"
```

This crate provides a macro to declare such variables:

```
#[macro_use]
extern crate lazy_static;

lazy_static! {
    static ref SEMVER: Regex
        = Regex::new(r"(\d+)\.(\d+)\.(\d+)(-[-.[:alnum:]]*)?")
            .expect("error parsing regex");
}
```

The macro expands to a declaration of a static variable named `SEMVER`, but its type is not exactly `Regex`. Instead, it's a macro-generated type that implements `Deref<Target=Regex>` and therefore exposes all the same methods as a `Regex`. The first time `SEMVER` is dereferenced, the initializer is evaluated, and the value saved for later use. Since `SEMVER` is a static variable, not just a local variable, the initializer runs at most once per program execution.

With this declaration in place, using `SEMVER` is straightforward:

```
use std::io::BufRead;

let stdin = std::io::stdin();
for line in stdin.lock().lines() {
    let line = line?;
    if let Some(match_) = SEMVER.find(&line) {
        println!("{}", match_.as_str());
    }
}
```



You can put the `lazy_static!` declaration in a module, or even inside the function that uses the `Regex`, if that's the most appropriate scope. The regular expression is still always compiled only once per program execution.

## Normalization

Most users would consider the French word for tea, *thé*, to be three characters long. However, Unicode actually has two ways to represent this text:

- In the *composed* form, *thé* comprises the three characters 't', 'h', and 'é', where 'é' is a single Unicode character with code point `0xe9`.
- In the *decomposed* form, *thé* comprises the four characters 't', 'h', 'e', and `\u{301}`, where the 'e' is the plain ASCII character, without an accent, and code point `0x301` is the “COMBINING ACUTE ACCENT” character, which adds an acute accent to whatever character it follows.

Unicode does not consider either the composed or the decomposed form of *é* to be the “correct” one; rather, it considers them both equivalent representations of the same abstract character. Unicode says both forms should be displayed in the same way, and text input methods are permitted to produce either, so users will generally not know which form they are viewing or typing. (Rust lets you use Unicode characters directly in string literals, so you can simply write “`thé`” if you don't care which encoding you get. Here we'll use the `\u` escapes for clarity.)

However, considered as Rust `&str` or `String` values, `"th\u{e9}"` and `"the\u{301}"` are completely distinct. They have different lengths, compare as unequal, have different hash values, and order themselves differently with respect to other strings:

```
assert!("th\u{e9}" != "the\u{301}");
assert!("th\u{e9}" > "the\u{301}");

// A Hasher is designed to accumulate the hash of a series of values,
// so hashing just one is a bit clunky.
use std::hash::{Hash, Hasher};
use std::collections::hash_map::DefaultHasher;
fn hash<T: ?Sized + Hash>(t: &T) -> u64 {
    let mut s = DefaultHasher::new();
    t.hash(&mut s);
    s.finish()
}

// These values may change in future Rust releases.
assert_eq!(hash("th\u{e9}"), 0x53e2d0734eb1dff3);
assert_eq!(hash("the\u{301}"), 0x90d837f0a0928144);
```

Clearly, if you intend to compare user-supplied text, or use it as a key in a hash table or B-tree, you will need to put each string in some canonical form first.

Fortunately, Unicode specifies *normalized* forms for strings. Whenever two strings should be treated as equivalent according to Unicode's rules, their normalized forms are character-for-character identical. When encoded with UTF-8, they are byte-for-byte identical. This means you can compare normalized strings with `==`, use them as keys in a `HashMap` or `HashSet`, and so on, and you'll get Unicode's notion of equality.

Failure to normalize can even have security consequences. For example, if your website normalizes usernames in some cases but not others, you could end up with two distinct users named `bananasflambé`, which some parts of your code treat as the same user, but others distinguish, resulting in one's privileges being extended incorrectly to the other. Of course, there are many ways to avoid this sort of problem, but history shows there are also many ways not to.

## Normalization Forms

Unicode defines four normalized forms, each of which is appropriate for different uses. There are two questions to answer:

- First, do you prefer characters to be as *composed* as possible or as *decomposed* as possible?

For example, the most composed representation of the Vietnamese word *Phở* is the three-character string `"Ph\u{1edf}"`, where both the tonal mark `̣` and the vowel mark `̣` are applied to the base character “o” in a single Unicode character, `'\u{1edf}'`, which Unicode dutifully names LATIN SMALL LETTER O WITH HORN AND HOOK ABOVE.

The most decomposed representation splits out the base letter and its two marks into three separate Unicode characters: `'o'`, `'\u{31b}'` (COMBINING HORN), and `'\u{309}'` (COMBINING HOOK ABOVE), resulting in `"Pho\u{31b}\u{309}"`. (Whenever combining marks appear as separate characters, rather than as part of a composed character, all normalized forms specify a fixed order in which they must appear, so normalization is well specified even when characters have multiple accents.)

The composed form generally has fewer compatibility problems, since it more closely matches the representations most languages used for their text before Unicode became established. It may also work better with naïve string formatting features like Rust's `format!` macro. The decomposed form, on the other hand, may be better for displaying text or searching, since it makes the detailed structure of the text more explicit.

- The second question is: if two character sequences represent the same fundamental text, but differ in the way that text should be formatted, do you want to treat them as equivalent, or keep them distinct?

Unicode has separate characters for the ordinary digit '5', the superscript digit '⁵' (or '\u{2075}'), and the circled digit '⑤' (or '\u{2464}'), but declares all three to be *compatibility equivalent*. Similarly, Unicode has a single character for the ligature *ffi* ('\u{fb03}'), but declares this to be compatibility equivalent to the three-character sequence "ffi".

Compatibility equivalence makes sense for searches: a search for "difficult", using only ASCII characters, ought to match the string "di\u{fb03}cult", which uses the *ffi* ligature. Applying compatibility decomposition to the latter string would replace the ligature with the three plain letters "ffi", making the search easier. But normalizing text to a compatibility equivalent form can lose essential information, so it should not be applied carelessly. For example, it would be incorrect in most contexts to store "2<sup>5</sup>" as "25".

The Unicode Normalization Form C and Normalization Form D (NFC and NFD) use the maximally composed and maximally decomposed forms of each character, but do not try to unify compatibility equivalent sequences. The NFKC and NFKD normalization forms are like NFC and NFD, but normalize all compatibility equivalent sequences to some simple representative of their class.

The World Wide Web Consortium's "Character Model For the World Wide Web" recommends using NFC for all content. The Unicode Identifier and Pattern Syntax annex suggests using NFKC for identifiers in programming languages, and offers principles for adapting the form when necessary.

## The unicode-normalization Crate

Rust's unicode-normalization crate provides a trait that adds methods to `&str` to put the text in any of the four normalized forms. To use it, add the following line to the [dependencies] section of your *Cargo.toml* file:

```
unicode-normalization = "0.1.5"
```

The top file of your crate needs an `extern crate` declaration:

```
extern crate unicode_normalization;
```

With these declarations in place, a `&str` has four new methods that return iterators over a particular normalized form of the string:

```
use unicode_normalization::UnicodeNormalization;

// No matter what representation the lefthand string uses
// (you shouldn't be able to tell just by looking),
// these assertions will hold.
assert_eq!("Phö".nfd().collect:::<String>(), "Ph\u{31b}\u{309}");
assert_eq!("Phö".nfc().collect:::<String>(), "Ph\u{1edf}");
```

```
// The lefthand side here uses the "ffi" ligature character.  
assert_eq!("Ⓞ Di\u{fb03}cully".nfkc().collect::<String>(), "1 Difficulty");
```

Taking a normalized string and normalizing it again in the same form is guaranteed to return identical text.

Although any substring of a normalized string is itself normalized, the concatenation of two normalized strings is not necessarily normalized: for example, the second string might start with combining characters that should be placed before combining characters at the end of the first string.

As long as a text uses no unassigned code points when it is normalized, Unicode promises that its normalized form will not change in future versions of the standard. This means that normalized forms are generally safe to use in persistent storage, even as the Unicode standard evolves.

---

# Input and Output

*Doolittle: What concrete evidence do you have that you exist?*

*Bomb #20: Hmmmm...well...I think, therefore I am.*

*Doolittle: That's good. That's very good. But how do you know that anything else exists?*

*Bomb #20: My sensory apparatus reveals it to me.*

— *Dark Star*

Rust's standard library features for input and output are organized around three traits—`Read`, `BufRead`, and `Write`—and the various types that implement them:

- Values that implement `Read` have methods for byte-oriented input. They're called *readers*.
- Values that implement `BufRead` are *buffered* readers. They support all the methods of `Read`, plus methods for reading lines of text and so forth.
- Values that implement `Write` support both byte-oriented and UTF-8 text output. They're called *writers*.

**Figure 18-1** shows these three traits and some examples of reader and writer types.

In this chapter, we'll show how to use these traits and their methods, the various types that implement them, and other ways to interact with files, the terminal, and the network.

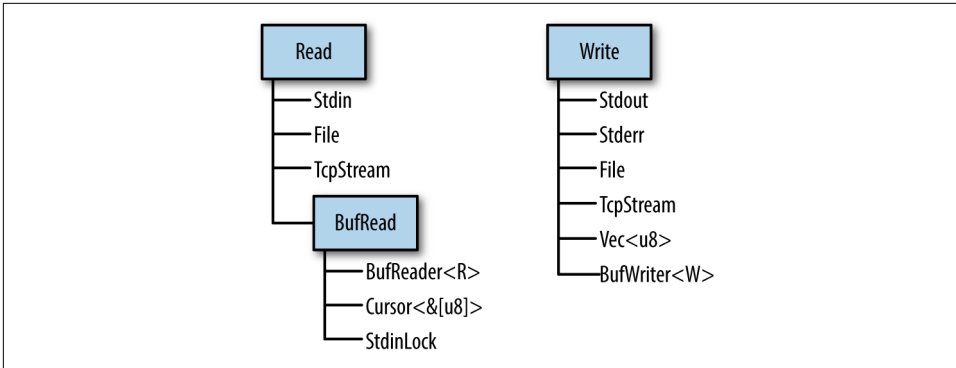

Figure 18-1. Selected reader and writer types from the Rust standard library

## Readers and Writers

*Readers* are values that your program can read bytes from. Examples include:

- Files opened using `std::fs::File::open(filename)`
- `std::net::TcpStreams`, for receiving data over the network
- `std::io::stdin()`, for reading from the process’s standard input stream
- `std::io::Cursor<&[u8]>` values, which are readers that “read” from a byte array that’s already in memory

*Writers* are values that your program can write bytes to. Examples include:

- Files opened using `std::fs::File::create(filename)`
- `std::net::TcpStreams`, for sending data over the network
- `std::io::stdout()` and `std::io::stderr()`, for writing to the terminal
- `std::io::Cursor<&mut [u8]>` values, which let you treat any mutable slice of bytes as a file for writing
- `Vec<u8>`, a writer whose write methods append to the vector

Since there are standard traits for readers and writers (`std::io::Read` and `std::io::Write`), it’s quite common to write generic code that works across a variety of input or output channels. For example, here’s a function that copies all bytes from any reader to any writer:

```
use std::io::{self, Read, Write, ErrorKind};

const DEFAULT_BUF_SIZE: usize = 8 * 1024;

pub fn copy<R: ?Sized, W: ?Sized>(reader: &mut R, writer: &mut W)
```

```

-> io::Result<u64>
where R: Read, W: Write
{
    let mut buf = [0; DEFAULT_BUF_SIZE];
    let mut written = 0;
    loop {
        let len = match reader.read(&mut buf) {
            Ok(0) => return Ok(written),
            Ok(len) => len,
            Err(ref e) if e.kind() == ErrorKind::Interrupted => continue,
            Err(e) => return Err(e),
        };
        writer.write_all(&buf[..len])?;
        written += len as u64;
    }
}

```

This is the implementation of `std::io::copy()` from Rust’s standard library. Since it’s generic, you can use it to copy data from a `File` to a `TcpStream`, from `Stdin` to an in-memory `Vec<u8>`, etc.

If the error-handling code here is unclear, revisit [Chapter 7](#). We’ll be using `Results` constantly in the pages ahead; it’s important to have a good grasp of how they work.

The four `std::io` traits `Read`, `BufRead`, `Write`, and `Seek` are so commonly used that there’s a `prelude` module containing only those traits:

```
use std::io::prelude::*;
```

You’ll see this once or twice in this chapter. We also make a habit of importing the `std::io` module itself:

```
use std::io::{self, Read, Write, ErrorKind};
```

The `self` keyword here declares `io` as an alias to the `std::io` module. That way, `std::io::Result` and `std::io::Error` can be written more concisely as `io::Result` and `io::Error`, and so on.

## Readers

`std::io::Read` has several methods for reading data. All of them take the reader itself by `mut` reference.

- **`reader.read(&mut buffer)`** reads some bytes from the data source and stores them in the given buffer. The type of the buffer argument is `&mut [u8]`. This reads up to `buffer.len()` bytes.

The return type is `io::Result<u64>`, which is a type alias for `Result<u64, io::Error>`. On success, the `u64` value is the number of bytes read—which may

be equal to or less than `buffer.len()`, *even if there's more data to come*, at the whim of the data source. `Ok(0)` means there is no more input to read.

On error, `.read()` returns `Err(err)`, where `err` is an `io::Error` value. An `io::Error` is printable, for the benefit of humans; for programs, it has a `.kind()` method that returns an error code of type `io::ErrorKind`. The members of this enum have names like `PermissionDenied` and `ConnectionReset`. Most indicate serious errors that can't be ignored, but one kind of error should be handled specially. `io::ErrorKind::Interrupted` corresponds to the Unix error code `EINTR`, which means the read happened to be interrupted by a signal. Unless the program is designed to do something clever with signals, it should just retry the read. The code for `copy()`, in the preceding section, shows an example of this.

As you can see, the `.read()` method is very low-level, even inheriting quirks of the underlying operating system. If you're implementing the `Read` trait for a new type of data source, this gives you a lot of leeway. If you're trying to read some data, it's a pain. Therefore, Rust provides several higher-level convenience methods. All of them have default implementations in terms of `.read()`. They all handle `ErrorKind::Interrupted`, so you don't have to.

- **`reader.read_to_end(&mut byte_vec)`** reads all remaining input from this reader, appending it to `byte_vec`, which is a `Vec<u8>`. Returns `io::Result<>`.

There is no limit on the amount of data this method will pile into the vector, so don't use it on an untrusted source. (You can impose a limit using the `.take()` method, described below.)

- **`reader.read_to_string(&mut string)`** is the same, but append the data to the given `String`. If the stream isn't valid UTF-8, this returns an `ErrorKind::InvalidData` error.

In some languages, byte input and character input are handled by different types. These days, UTF-8 is so dominant that Rust acknowledges this de facto standard and supports UTF-8 everywhere. Other character sets are supported with the open source encoding crate.

- **`reader.read_exact(&mut buf)`** reads exactly enough data to fill the given buffer. The argument type is `&[u8]`. If the reader runs out of data before reading `buf.len()` bytes, this returns an `ErrorKind::UnexpectedEof` error.

Those are the main methods of the `Read` trait. In addition, there are four adapter methods that take the reader by value, transforming it into an iterator or a different reader:

- **`reader.bytes()`** returns an iterator over the bytes of the input stream. The item type is `io::Result<u8>`, so an error check is required for every byte. Further-



more, this calls `reader.read()` once per byte, which will be very inefficient if the reader is not buffered.

- **`reader.chars()`** is the same, but iterates over characters, treating the input as UTF-8. Invalid UTF-8 causes an `InvalidData` error.
- **`reader.chain(reader2)`** returns a new reader that produces all the input from `reader`, followed by all the input from `reader2`.
- **`reader.take(n)`** returns a new reader that reads from the same source as `reader`, but is limited to `n` bytes of input.

There is no method for closing a reader. Readers and writers typically implement `Drop` so that they are closed automatically.

## Buffered Readers

For efficiency, readers and writers can be *buffered*, which simply means they have a chunk of memory (a buffer) that holds some input or output data in memory. This saves on system calls, as shown in [Figure 18-2](#). The application reads data from the `BufReader`, in this example by calling its `.read_line()` method. The `BufReader` in turn gets its input in larger chunks from the operating system.

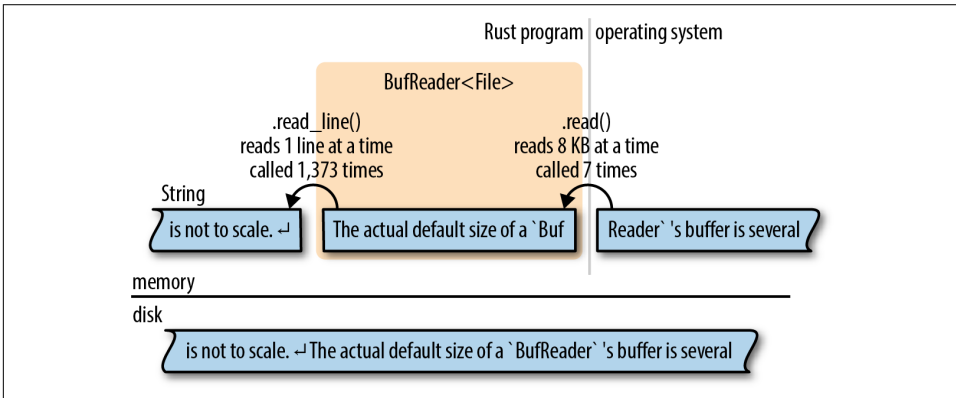

Figure 18-2. A buffered file reader

This picture is not to scale. The actual default size of a `BufReader`'s buffer is several kilobytes, so a single system read can serve hundreds of `.read_line()` calls. This matters because system calls are slow.

(As the picture shows, the operating system has a buffer too, for the same reason: system calls are slow, but reading data from a disk is slower.)

Buffered readers implement both `Read` and a second trait, `BufRead`, which adds the following methods:

- **`reader.read_line(&mut line)`** reads a line of text and appends it to `line`, which is a `String`. The newline character `'\n'` at the end of the line is included in `line`. If the input has Windows-style line endings, `"\r\n"`, both characters are included in `line`.

The return value is an `io::Result<usize>`, the number of bytes read, including the line ending, if any.

If the reader is at the end of the input, this leaves `line` unchanged and returns `Ok(0)`.

- **`reader.lines()`** returns an iterator over the lines of the input. The item type is `io::Result<String>`. Newline characters are *not* included in the strings. If the input has Windows-style line endings, `"\r\n"`, both characters are stripped.

This method is almost always what you want for text input. The next two sections show some examples of its use.

- **`reader.read_until(stop_byte, &mut byte_vec)`** and **`reader.split(stop_byte)`** are just like `.read_line()` and `.lines()`, but byte-oriented, producing `Vec<u8>`s instead of `Strings`. You choose the delimiter `stop_byte`.

`BufRead` also provides a pair of low-level methods, `.fill_buf()` and `.consume(n)`, for direct access to the reader's internal buffer. For more about these methods, see the online documentation.

The next two sections cover buffered readers in more detail.

## Reading Lines

Here is a function that implements the Unix `grep` utility. It searches many lines of text, typically piped in from another command, for a given string:

```
use std::io;
use std::io::prelude::*;

fn grep(target: &str) -> io::Result<()> {
    let stdin = io::stdin();
    for line_result in stdin.lock().lines() {
        let line = line_result?;
        if line.contains(target) {
            println!("{}", line);
        }
    }
    Ok(())
}
```

Since we want to call `.lines()`, we need a source of input that implements `BufRead`. In this case, we call `io::stdin()` to get the data that's being piped to us. However, the Rust standard library protects `stdin` with a mutex. We call `.lock()` to lock `stdin` for the current thread's exclusive use; it returns a `StdinLock` value that implements `BufRead`. At the end of the loop, the `StdinLock` is dropped, releasing the mutex. (Without a mutex, two threads trying to read from `stdin` at the same time would cause undefined behavior. C has the same issue and solves it the same way: all of the C standard input and output functions obtain a lock behind the scenes. The only difference is that in Rust, the lock is part of the API.)

The rest of the function is straightforward: it calls `.lines()` and loops over the resulting iterator. Because this iterator produces `Result` values, we use the `?` operator to check for errors.

Suppose we want to take our `grep` program a step further and add support for searching files on disk. We can make this function generic:

```
fn grep<R>(target: &str, reader: R) -> io::Result<()>
    where R: BufRead
{
    for line_result in reader.lines() {
        let line = line_result?;
        if line.contains(target) {
            println!("{}", line);
        }
    }
    Ok(())
}
```

Now we can pass it either a `StdinLock` or a buffered `File`:

```
let stdin = io::stdin();
grep(&target, stdin.lock())?; // ok

let f = File::open(file)?;
grep(&target, BufReader::new(f))?; // also ok
```

Note that a `File` is not automatically buffered. `File` implements `Read` but not `BufRead`. However, it's easy to create a buffered reader for a `File`, or any other unbuffered reader. `BufReader::new(reader)` does this. (To set the size of the buffer, use `BufReader::with_capacity(size, reader)`.)

In most languages, files are buffered by default. If you want unbuffered input or output, you have to figure out how to turn buffering off. In Rust, `File` and `BufReader` are two separate library features, because sometimes you want files without buffering, and sometimes you want buffering without files (for example, you may want to buffer input from the network).

The full program, including error handling and some crude argument parsing, is shown here:

```
// grep - Search stdin or some files for lines matching a given string.

use std::error::Error;
use std::io::{self, BufReader};
use std::io::prelude::*;
use std::fs::File;
use std::path::PathBuf;

fn grep<R>(target: &str, reader: R) -> io::Result<()>
    where R: BufRead
{
    for line_result in reader.lines() {
        let line = line_result?;
        if line.contains(target) {
            println!("{}", line);
        }
    }
    Ok(())
}

fn grep_main() -> Result<(), Box<Error>> {
    // Get the command-line arguments. The first argument is the
    // string to search for; the rest are filenames.
    let mut args = std::env::args().skip(1);
    let target = match args.next() {
        Some(s) => s,
        None => Err("usage: grep PATTERN FILE...")?
    };
    let files: Vec<PathBuf> = args.map(PathBuf::from).collect();

    if files.is_empty() {
        let stdin = io::stdin();
        grep(&target, stdin.lock())?;
    } else {
        for file in files {
            let f = File::open(file)?;
            grep(&target, BufReader::new(f))?;
        }
    }
    Ok(())
}

fn main() {
    let result = grep_main();
    if let Err(err) = result {
        let _ = writeln!(io::stderr(), "{}", err);
    }
}
```

## Collecting Lines

Several reader methods, including `.lines()`, return iterators that produce `Result` values. The first time you want to collect all the lines of a file into one big vector, you'll run into a problem getting rid of the `Results`.

```
// ok, but not what you want
let results: Vec<io::Result<String>> = reader.lines().collect();

// error: can't convert collection of Results to Vec<String>
let lines: Vec<String> = reader.lines().collect();
```

The second try doesn't compile: what would happen to the errors? The straightforward solution is to write a `for` loop and check each item for errors:

```
let mut lines = vec![];
for line_result in reader.lines() {
    lines.push(line_result?);
}
```

Not bad; but it would be nice to use `.collect()` here, and it turns out that we can. We just have to know which type to ask for:

```
let lines = reader.lines().collect::<io::Result<Vec<String>>>()?;
```

How does this work? The standard library contains an implementation of `FromIterator` for `Result`—easy to overlook in the online documentation—that makes this possible:

```
impl<T, E, C> FromIterator<Result<T, E>> for Result<C, E>
where C: FromIterator<T>
{
    ...
}
```

This says: if you can collect items of type `T` into a collection of type `C` (“where `C: FromIterator<T>`”) then you can collect items of type `Result<T, E>` into a result of type `Result<C, E>` (“`FromIterator<Result<T, E>>` for `Result<C, E>`”).

In other words, `io::Result<Vec<String>>` is a collection type, so the `.collect()` method can create and populate values of that type.

## Writers

As we've seen, input is mostly done using methods. Output is a bit different.

Throughout the book, we've used `println!()` to produce plain-text output.

```
println!("Hello, world!");

println!("The greatest common divisor of {:?} is {}",
        numbers, d);
```

There's also a `print!()` macro, which does not add a newline character at the end. The formatting codes for `print!()` and `println!()` are the same as those for the `format!` macro, described in “[Formatting Values](#)” on page 413.

To send output to a writer, use the `write!()` and `writeln!()` macros. They are the same as `print!()` and `println!()`, except for two differences.

```
writeln!(io::stderr(), "error: world not helloable");

writeln!(&mut byte_vec, "The greatest common divisor of {:?} is {:?}",
         numbers, d)?;
```

One difference is that the `write` macros each take an extra first argument, a writer. The other is that they return a `Result`, so errors must be handled. That's why we used the `?` operator at the end of each line.

The `print` macros don't return a `Result`; they simply panic if the write fails. Since they write to the terminal, this is rare.

The `Write` trait has these methods:

- **`writer.write(&buf)`** writes some of the bytes in the slice `buf` to the underlying stream. It returns an `io::Result<usize>`. On success, this gives the number of bytes written, which may be less than `buf.len()`, at the whim of the stream. Like `Reader::read()`, this is a low-level method that you should avoid using directly.
- **`writer.write_all(&buf)`** writes all the bytes in the slice `buf`. Returns `Result<>`.
- **`writer.flush()`** flushes any buffered data to the underlying stream. Returns `Result<>`.

Like readers, writers are closed automatically when they are dropped.

Just as `BufReader::new(reader)` adds a buffer to any reader, `BufWriter::new(writer)` adds a buffer to any writer.

```
let file = File::create("tmp.txt");
let writer = BufWriter::new(file);
```

To set the size of the buffer, use `BufWriter::with_capacity(size, writer)`.

When a `BufWriter` is dropped, all remaining buffered data is written to the underlying writer. However, if an error occurs during this write, the error is *ignored*. (Since this happens inside `BufWriter`'s `.drop()` method, there is no useful place to report the error.) To make sure your application notices all output errors, manually `.flush()` buffered writers before dropping them.

## Files

We've already seen two ways to open a file:

- **File::open(filename)** opens an existing file for reading. It returns an `io::Result<File>`, and it's an error if the file doesn't exist.
- **File::create(filename)** creates a new file for writing. If a file exists with the given filename, it is truncated.

Note that the `File` type is in the filesystem module, `std::fs`, not `std::io`.

When neither of these fits the bill, you can use `OpenOptions` to specify the exact desired behavior:

```
use std::fs::OpenOptions;

let log = OpenOptions::new()
    .append(true) // if file exists, add to the end
    .open("server.log"?);

let file = OpenOptions::new()
    .write(true)
    .create_new(true) // fail if file exists
    .open("new_file.txt"?);
```

The methods `.append()`, `.write()`, `.create_new()`, and so on are designed to be chained like this: each one returns `self`. This method-chaining design pattern is common enough to have a name in Rust: it's called a *builder*. `std::process::Command` is another example. For more details on `OpenOptions`, see the online documentation.

Once a `File` has been opened, it behaves like any other reader or writer. You can add a buffer if needed. The `File` will be closed automatically when you drop it.

## Seeking

`File` also implements the `Seek` trait, which means you can hop around within a `File` rather than reading or writing in a single pass from the beginning to the end. `Seek` is defined like this:

```
pub trait Seek {
    fn seek(&mut self, pos: SeekFrom) -> io::Result<u64>;
}

pub enum SeekFrom {
    Start(u64),
    End(i64),
    Current(i64)
}
```

Thanks to the enum, the `seek` method is nicely expressive: use `file.seek(SeekFrom::Start(0))` to rewind to the beginning, `file.seek(SeekFrom::Current(-8))` to go back a few bytes, and so on.

Seeking within a file is slow. Whether you're using a hard disk or a solid-state drive (SSD), a seek takes as long as reading several megabytes of data.

## Other Reader and Writer Types

Earlier in this chapter, we gave a few examples of types other than `File` that implement `Read` and `Write`. Here, we'll give a few more details about these types.

- **`io::stdin()`** returns a reader for the standard input stream. Its type is `io::Stdin`. Since this is shared by all threads, each read acquires and releases a mutex.

`Stdin` has a `.lock()` method that acquires the mutex and returns an `io::StdinLock`, a buffered reader that holds the mutex until it's dropped. Individual operations on the `StdinLock` therefore avoid the mutex overhead. We showed example code using this method in [“Reading Lines” on page 436](#).

For technical reasons, `io::stdin().lock()` doesn't work. The lock holds a reference to the `Stdin` value, and that means the `Stdin` value must be stored somewhere so that it lives long enough:

```
let stdin = io::stdin();
let lines = stdin.lock().lines(); // ok
```

- **`io::stdout()`** and **`io::stderr()`** return writers for the standard output and standard error streams. These too have mutexes and `.lock()` methods.
- **`Vec<u8>`** implements `Write`. Writing to a `Vec<u8>` extends the vector with the new data.

(`String`, however, does *not* implement `Write`. To build a string using `Write`, first write to a `Vec<u8>`, then use `String::from_utf8(vec)` to convert the vector to a string.)

- **`Cursor::new(buf)`** creates a `Cursor`, a buffered reader that reads from `buf`. This is how you create a reader that reads from a `String`. The argument `buf` can be any type that implements `AsRef<[u8]>`, so you can also pass a `&[u8]`, `&str`, or `Vec<u8>`.

`Cursors` are trivial internally. They have just two fields: `buf` itself; and an integer, the offset in `buf` where the next read will start. The position is initially 0.

`Cursors` implement `Read`, `BufRead`, and `Seek`. If the type of `buf` is `&mut [u8]` or `Vec<u8>`, then the `Cursor` also implements `Write`. Writing to a cursor overwrites



bytes in `buf` starting at the current position. If you try to write past the end of a `&mut [u8]`, you'll get a partial write or an `io::Error`. Using a cursor to write past the end of a `Vec<u8>` is fine, though: it grows the vector. `Cursor<&mut [u8]>` and `Cursor<Vec<u8>>` thus implement all four of the `std::io::prelude` traits.

- `std::net::TcpStream` represents a TCP network connection. Since TCP enables two-way communication, it's both a reader and a writer.

The static method `TcpStream::connect(("hostname", PORT))` tries to connect to a server and returns an `io::Result<TcpStream>`.

- `std::process::Command` supports spawning a child process and piping data to its standard input, like so:

```
use std::process::{Command, Stdio};

let mut child =
    Command::new("grep")
        .arg("-e")
        .arg("a.*e.*i.*o.*u")
        .stdin(Stdio::piped())
        .spawn()?;

let mut to_child = child.stdin.take().unwrap();
for word in my_words {
    writeln!(to_child, "{}", word)?;
}
drop(to_child); // close grep's stdin, so it will exit
child.wait()?;
```

The type of `child.stdin` is `Option<std::process::ChildStdin>`; here we've used `.stdin(Stdio::piped())` when setting up the child process, so `child.stdin` is definitely populated when `.spawn()` succeeds. If we hadn't, `child.stdin` would be `None`.

`Command` also has similar methods `.stdout()` and `.stderr()`, which can be used to request readers in `child.stdout` and `child.stderr`.

The `std::io` module also offers a handful of functions that return trivial readers and writers.

- `io::sink()` is the no-op writer. All the write methods return `Ok`, but the data is just discarded.
- `io::empty()` is the no-op reader. Reading always succeeds, but returns end-of-input.
- `io::repeat(byte)` returns a reader that repeats the given byte endlessly.

## Binary Data, Compression, and Serialization

Many open source crates build on the `std::io` framework to offer extra features.

The `byteorder` crate offers `ReadBytesExt` and `WriteBytesExt` traits that add methods to all readers and writers for binary input and output:

```
use byteorder::{ReadBytesExt, WriteBytesExt, LittleEndian};

let n = reader.read_u32::()?;
writer.write_i64::(n as i64)?;
```

The `flate2` crate provides adapter methods for reading and writing gzipped data:

```
use flate2::FlateReadExt;

let file = File::open("access.log.gz")?;
let mut gzip_reader = file.gz_decode()?;
```

The `serde` crate is for serialization and deserialization: it converts back and forth between Rust structs and bytes. We mentioned this once before, in “[Traits and Other People’s Types](#)” on page 247. Now we can take a closer look.

Suppose we have some data—the map for a text adventure game—stored in a `HashMap`:

```
type RoomId = String; // each room has a unique name
type RoomExits = Vec<(char, RoomId)>; // ...and a list of exits
type RoomMap = HashMap<RoomId, RoomExits>; // room names and exits, simple

// Create a simple map.
let mut map = RoomMap::new();
map.insert("Cobble Crawl".to_string(),
          vec![('W', "Debris Room".to_string())]);
map.insert("Debris Room".to_string(),
          vec![('E', "Cobble Crawl".to_string()),
               ('W', "Sloping Canyon".to_string())]);
...

```

Turning this data into JSON for output is just a few lines of code:

```
use std::io;
use serde::Serialize;
use serde_json::Serializer;

let mut serializer = Serializer::new(io::stdout());
map.serialize(&mut serializer)?;
```

This code uses the `serialize` method of the `serde::Serialize` trait. The library attaches this trait to all types that it knows how to serialize, and that includes all of the types that appear in our data: strings, characters, tuples, vectors, and `HashMap`s.

serde is flexible. In this program, the output is JSON data, because we chose the `serde_json` serializer. Other formats, like `MessagePack`, are also available. Likewise, you could send this output to a file, a `Vec<u8>`, or any other writer. The code above prints the data on `stdout`. Here it is:

```
{"Debris Room": [{"E", "Cobble Crawl"}, {"W", "Sloping Canyon"}], "Cobble Crawl": [{"W", "Debris Room"}]}
```

serde also includes support for deriving the two key serde traits:

```
#[derive(Serialize, Deserialize)]
struct Player {
    location: String,
    items: Vec<String>,
    health: u32
}
```

As of Rust 1.17, this `#[derive]` attribute requires a few extra steps when setting up your project. We won't cover that here; see the `serde` documentation for details. In short, the build system autogenerates implementations of `serde::Serialize` and `serde::Deserialize` for `Player`, so that serializing a `Player` value is simple:

```
player.serialize(&mut serializer)?;
```

The output looks like this:

```
{"location": "Cobble Crawl", "items": ["a wand"], "health": 3}
```

## Files and Directories

The next few sections cover Rust's features for working with files and directories, which live in the `std::path` and `std::fs` modules. All of these features involve working with filenames, so we'll start with the filename types.

### OsStr and Path

Inconveniently, your operating system does not force filenames to be valid Unicode. Here are two Linux shell commands that create text files. Only the first uses a valid UTF-8 filename.

```
$ echo "hello world" > ô.txt
$ echo "O brave new world, that has such filenames in't" > '$\xf4'.txt
```

Both commands pass without comment, because the Linux kernel doesn't know UTF-8 from Ogg Vorbis. To the kernel, any string of bytes (excluding null bytes and slashes) is an acceptable filename. It's a similar story on Windows: almost any string of 16-bit "wide characters" is an acceptable filename, even strings that are not valid UTF-16. The same is true of other strings the operating system handles, like command-line arguments and environment variables.

Rust strings are always valid Unicode. Filenames are *almost* always Unicode in practice, but Rust has to cope somehow with the rare case where they aren't. This is why Rust has `std::ffi::OsStr` and `OsString`.

`OsStr` is a string type that's a superset of UTF-8. Its job is to be able to represent all filenames, command-line arguments, and environment variables on the current system, *whether they're valid Unicode or not*. On Unix, an `OsStr` can hold any sequence of bytes. On Windows, an `OsStr` is stored using an extension of UTF-8 that can encode any sequence of 16-bit-values, including unmatched surrogates.

So we have two string types: `str` for actual Unicode strings; and `OsStr` for whatever nonsense your operating system can dish out. We'll introduce one more: `std::path::Path`, for filenames. This one is purely a convenience. `Path` is exactly like `OsStr`, but it adds many handy filename-related methods, which we'll cover in the next section. Use `Path` for both absolute and relative paths. For an individual component of a path, use `OsStr`.

Lastly, for each string type, there's a corresponding *owning* type: a `String` owns a heap-allocated `str`, a `std::ffi::OsString` owns a heap-allocated `OsStr`, and a `std::path::PathBuf` owns a heap-allocated `Path`.

	<code>str</code>	<code>OsStr</code>	<code>Path</code>
Unsize type, always passed by reference	Yes	Yes	Yes
Can contain any Unicode text	Yes	Yes	Yes
Looks just like UTF-8, normally	Yes	Yes	Yes
Can contain non-Unicode data	No	Yes	Yes
Text processing methods	Yes	No	No
Filename-related methods	No	No	Yes
Owned, growable, heap-allocated equivalent	<code>String</code>	<code>OsString</code>	<code>PathBuf</code>
Convert to owned type	<code>.to_string()</code>	<code>.to_os_string()</code>	<code>.to_path_buf()</code>

All three of these types implement a common trait, `AsRef<Path>`, so we can easily declare a generic function that accepts “any filename type” as an argument. This uses a technique we showed in “[AsRef and AsMut](#)” on page 294:

```
use std::path::Path;
use std::io;

fn swizzle_file<P>(path_arg: P) -> io::Result<>
where P: AsRef<Path>
{
    let path = path_arg.as_ref();
    ...
}
```

All the standard functions and methods that take `path` arguments use this technique, so you can freely pass string literals to any of them.

## Path and PathBuf Methods

Path offers the following methods, among others:

- **Path::new(str)** converts a `&str` or `&OsStr` to a `&Path`. This doesn't copy the string: the new `&Path` points to the same bytes as the original `&str` or `&OsStr`.

```
use std::path::Path;
let home_dir = Path::new("/home/fwolfe");
```

(The similar method `OsStr::new(str)` converts a `&str` to a `&OsStr`.)

- **path.parent()** returns the path's parent directory, if any. The return type is `Option<&Path>`.

This doesn't copy the path: the parent directory of `path` is always a substring of `path`.

```
assert_eq!(Path::new("/home/fwolfe/program.txt").parent(),
           Some(Path::new("/home/fwolfe")));
```

- **path.file\_name()** returns the last component of `path`, if any. The return type is `Option<&OsStr>`.

In the typical case, where `path` consists of a directory, then a slash, then a filename, this returns the filename.

```
assert_eq!(Path::new("/home/fwolfe/program.txt").file_name(),
           Some(OsStr::new("program.txt")));
```

- **path.is\_absolute()** and **path.is\_relative()** tell whether the file is absolute, like the Unix path `/usr/bin/advent` or the Windows path `C:\Program Files`; or relative, like `src/main.rs`.
- **path1.join(path2)** joins two paths, returning a new `PathBuf`.

```
let path1 = Path::new("/usr/share/dict");
assert_eq!(path1.join("words"),
           Path::new("/usr/share/dict/words"));
```

If `path2` is an absolute path, this just returns a copy of `path2`, so this method can be used to convert any path to an absolute path:

```
let abs_path = std::env::current_dir()?.join(any_path);
```

- **path.components()** returns an iterator over the components of the given path, from left to right. The item type of this iterator is `std::path::Component`, an enum that can represent all the different pieces that can appear in filenames:

```

pub enum Component<'a> {
    Prefix(PrefixComponent<'a>), // Windows-only: a drive letter or share
    RootDir, // the root directory, '/' or '\'
    CurDir, // the '.' special directory
    ParentDir, // the '..' special directory
    Normal(&'a OsStr) // plain file and directory names
}

```

For example, the Windows path `\\venice\Music\A Love Supreme\04-Psalms.mp3` consists of a `Prefix` representing `\\venice\Music`, followed by a `RootDir`, and then two `Normal` components representing `A Love Supreme` and `04-Psalms.mp3`.

For details, see [the online documentation](#).

These methods work on strings in memory. Paths also have some methods that query the filesystem: `.exists()`, `.is_file()`, `.is_dir()`, `.read_dir()`, `.canonicalize()`, and so on. See the online documentation to learn more.

There are three methods for converting Paths to strings. Each one allows for the possibility of invalid UTF-8 in the Path.

- `path.to_str()` converts a Path to a string, as an `Option<str>`. If path isn't valid UTF-8, this returns `None`.

```

if let Some(file_str) = path.to_str() {
    println!("{}", file_str);
} // ...otherwise skip this weirdly named file

```

- `path.to_string_lossy()` is basically the same thing, but it manages to return some sort of string in all cases. If path isn't valid UTF-8, these methods make a copy, replacing each invalid byte sequence with the Unicode replacement character, U+FFFD (‘’).

The return type is `std::borrow::Cow<str>`: an either-borrowed-or-owned string. To get a `String` from this value, use its `.to_owned()` method. (For more about `Cow`, see [“Borrow and ToOwned at Work: The Humble Cow” on page 300](#).)

- `path.display()` is for printing paths:

```
println!("Download found. You put it in: {}", dir_path.display());
```

The value this returns isn't a string, but it implements `std::fmt::Display`, so it can be used with `format!()`, `println!()`, and friends. If the path isn't valid UTF-8, the output may contain the  character.

## Filesystem Access Functions

Table 18-1 shows some of the functions in `std::fs` and their approximate equivalents on Unix and Windows. All of these functions return `io::Result` values. They are `Result<>` unless otherwise noted.

Table 18-1. Summary of filesystem access functions

	Rust function	Unix	Windows
<b>Creating and deleting</b>	<code>create_dir(path)</code>	<code>mkdir()</code>	<code>CreateDirectory()</code>
	<code>create_dir_all(path)</code>	like <code>mkdir -p</code>	like <code>mkdir</code>
	<code>remove_dir(path)</code>	<code>rmdir()</code>	<code>RemoveDirectory()</code>
	<code>remove_dir_all(path)</code>	like <code>rm -r</code>	like <code>rmdir /s</code>
	<code>remove_file(path)</code>	<code>unlink()</code>	<code>DeleteFile()</code>
<b>Copying, moving, and linking</b>	<code>copy(src_path, dest_path) -&gt; Result&lt;u64&gt;</code>	like <code>cp -p</code>	<code>CopyFileEx()</code>
	<code>rename(src_path, dest_path)</code>	<code>rename()</code>	<code>MoveFileEx()</code>
	<code>hard_link(src_path, dest_path)</code>	<code>link()</code>	<code>CreateHardLink()</code>
<b>Inspecting</b>	<code>canonicalize(path) -&gt; Result&lt;PathBuf&gt;</code>	<code>realpath()</code>	<code>GetFinalPathNameByHandle()</code>
	<code>metadata(path) -&gt; Result&lt;Metadata&gt;</code>	<code>stat()</code>	<code>GetFileInformationByHandle()</code>
	<code>symlink_metadata(path) -&gt; Result&lt;Metadata&gt;</code>	<code>lstat()</code>	<code>GetFileInformationByHandle()</code>
	<code>read_dir(path) -&gt; Result&lt;ReadDir&gt;</code>	<code>opendir()</code>	<code>FindFirstFile()</code>
	<code>read_link(path) -&gt; Result&lt;PathBuf&gt;</code>	<code>readlink()</code>	<code>FSCTL_GET_REPARSE_POINT</code>
<b>Permissions</b>	<code>set_permissions(path, perm)</code>	<code>chmod()</code>	<code>SetFileAttributes()</code>

(The number returned by `copy()` is the size of the copied file, in bytes. For creating symbolic links, see “[Platform-Specific Features](#)” on page 451.)

As you can see, Rust strives to provide portable functions that work predictably on Windows as well as macOS, Linux, and other Unix systems.

A full tutorial on filesystems is beyond the scope of this book, but if you’re curious about any of these functions, you can easily find more about them online. We’ll show some examples in the next section.

All of these functions are implemented by calling out to the operating system. For example, `std::fs::canonicalize(path)` does not merely use string processing to

eliminate `.` and `..` from the given path. It resolves relative paths using the current working directory, and it chases symbolic links. It's an error if the path doesn't exist.

The `Metadata` type produced by `std::fs::metadata(path)` and `std::fs::symlink_metadata(path)` contains such information as the file type and size, permissions, and timestamps. As always, consult the documentation for details.

As a convenience, the `Path` type has a few of these built in as methods: `path.metadata()`, for example, is the same thing as `std::fs::metadata(path)`.

## Reading Directories

To list the contents of a directory, use `std::fs::read_dir`, or equivalently, the `.read_dir()` method of a `Path`:

```
for entry_result in path.read_dir()? {
    let entry = entry_result?;
    println!("{}", entry.file_name().to_string_lossy());
}
```

Note the two uses of `?` in this code. The first line checks for errors opening the directory. The second line checks for errors reading the next entry.

The type of `entry` is `std::fs::DirEntry`, and it's a struct with just a few methods:

- **`entry.file_name()`** is the name of the file or directory, as an `OsString`.
- **`entry.path()`** is the same, but with the original path joined to it, producing a new `PathBuf`. If the directory we're listing is `"/home/jimb"`, and `entry.file_name()` is `".emacs"`, then `entry.path()` would return `PathBuf::from("/home/jimb/.emacs")`.
- **`entry.file_type()`** returns an `io::Result<FileType>`. `FileType` has `.is_file()`, `.is_dir()`, and `.is_symlink()` methods.
- **`entry.metadata()`** gets the rest of the metadata about this entry.

The special directories `.` and `..` are *not* listed when reading a directory.

Here's a more substantial example. The following code recursively copies a directory tree from one place to another on disk:

```
use std::fs;
use std::io;
use std::path::Path;

/// Copy the existing directory `src` to the target path `dst`.
fn copy_dir_to(src: &Path, dst: &Path) -> io::Result<> {
    if !dst.is_dir() {
        fs::create_dir(dst)?;
    }
}
```



```

    }

    for entry_result in src.read_dir()? {
        let entry = entry_result?;
        let file_type = entry.file_type()?;
        copy_to(&entry.path(), &file_type, &dst.join(entry.file_name()))?;
    }

    Ok(())
}

```

A separate function, `copy_to`, copies individual directory entries:

```

/// Copy whatever is at `src` to the target path `dst`.
fn copy_to(src: &Path, src_type: &fs::FileType, dst: &Path) -> io::Result<> {
    if src_type.is_file() {
        fs::copy(src, dst)?;
    } else if src_type.is_dir() {
        copy_dir_to(src, dst)?;
    } else {
        return Err(io::Error::new(io::ErrorKind::Other,
            format!("don't know how to copy: {}",
                src.display())));
    }
    Ok(())
}

```

## Platform-Specific Features

So far, our `copy_to` function can copy files and directories. Suppose we also want to support symbolic links on Unix.

There is no portable way to create symbolic links that works on both Unix and Windows, but the standard library offers a Unix-specific `symlink` function,

```
use std::os::unix::fs::symlink;
```

and with this, our job is easy. We need only add a branch to the `if`-expression in `copy_to`:

```

...
} else if src_type.is_symlink() {
    let target = src.read_link()?;
    symlink(target, dst)?;
...

```

This will work as long as we compile our program only for Unix systems, such as Linux and macOS.

The `std::os` module contains various platform-specific features, like `symlink`. The actual body of `std::os` in the standard library looks like this (taking some poetic license):

```

///! OS-specific functionality.

#[cfg(unix)]           pub mod unix;
#[cfg(windows)]       pub mod windows;
#[cfg(target_os = "ios")] pub mod ios;
#[cfg(target_os = "linux")] pub mod linux;
#[cfg(target_os = "macos")] pub mod macos;
...

```

The `#[cfg]` attribute indicates conditional compilation: each of these modules exists only on some platforms. This is why our modified program, using `std::os::unix`, will successfully compile only for Unix: on other platforms, `std::os::unix` doesn't exist.

If we want our code to compile on all platforms, with support for symbolic links on Unix, we must use `#[cfg]` in our program as well. In this case, it's easiest to import `symlink` on Unix, while defining our own `symlink` stub on other systems:

```

#[cfg(unix)]
use std::os::unix::fs::symlink;

/// Stub implementation of `symlink` for platforms that don't provide it.
#[cfg(not(unix))]
fn symlink<P: AsRef<Path>, Q: AsRef<Path>>(src: P, _dst: Q)
    -> std::io::Result<>
{
    Err(io::Error::new(io::ErrorKind::Other,
                       format!("can't copy symbolic link: {}",
                                src.as_ref().display())))
}

```

As of this writing, the online documentation at <https://doc.rust-lang.org/std> is generated by running `rustdoc` on the standard library—on *Linux*. This means that system-specific functionality for macOS, Windows, and other platforms does not show up in the online documentation. The best way to find it is to use `rustup doc` to see the HTML documentation for your platform. Of course, another option is to consult the [source code](#), which is available online.

It turns out that `symlink` is something of a special case. Most Unix-specific features are not standalone functions but rather extension traits that add new methods to standard library types. (We covered extension traits in “[Traits and Other People's Types](#)” on page 247.) There's a `prelude` module that can be used to enable all of these extensions at once:

```
use std::os::unix::prelude::*;
```

For example, on Unix, this adds a `.mode()` method to `std::fs::Permissions`, providing access to the underlying `u32` value that represents permissions on Unix. Simi-

larly, it extends `std::fs::Metadata` with accessors for the fields of the underlying struct `stat` value—such as `.uid()`, the user ID of the file’s owner.

All told, what’s in `std::os` is pretty basic. Much more platform-specific functionality is available via third-party crates, like `winreg` for accessing the Windows registry.

## Networking

A tutorial on networking is well beyond the scope of this book. However, if you already know a bit about network programming, this section will help you get started with networking in Rust.

For low-level networking code, start with the `std::net` module, which provides cross-platform support for TCP and UDP networking. Use the `native_tls` crate for SSL/TLS support.

These modules provide the building blocks for straightforward, blocking input and output over the network. You can write a simple server in a few lines of code, using `std::net` and spawning a thread for each connection. For example, here’s an “echo” server:

```
use std::net::TcpListener;
use std::io;
use std::thread::spawn;

// Accept connections forever, spawning a thread for each one.
fn echo_main(addr: &str) -> io::Result<()> {
    let listener = TcpListener::bind(addr)?;
    println!("listening on {}", addr);
    loop {
        // Wait for a client to connect.
        let (mut stream, addr) = listener.accept()?;
        println!("connection received from {}", addr);

        // Spawn a thread to handle this client.
        let mut write_stream = stream.try_clone()?;
        spawn(move || {
            // Echo everything we receive from `stream` back to it.
            io::copy(&mut stream, &mut write_stream)
                .expect("error in client thread: ");
            println!("connection closed");
        });
    }
}

fn main() {
    echo_main("127.0.0.1:17007").expect("error: ");
}
```

An echo server simply repeats back everything you send to it. This kind of code is not so different from what you'd write in Java or Python. (We'll cover `std::thread::spawn()` in [the next chapter](#).)

However, for high-performance servers, you'll need to use asynchronous input and output. The `mio` crate provides the needed support. MIO is very low-level. It provides a simple event loop and asynchronous methods for reading, writing, connecting, and accepting connections—basically an asynchronous copy of the whole networking API. Whenever an asynchronous operation completes, MIO passes an event to an event handler method that you write.

There's also the experimental `tokio` crate, which wraps the `mio` event loop in a futures-based API, reminiscent of JavaScript promises.

Higher-level protocols are supported by third-party crates. For example, the `request` crate offers a beautiful API for HTTP clients. Here is a complete command-line program that fetches any document with an `http:` or `https:` URL and dumps it to your terminal. This code was written using `request = "0.5.1"`.

```
extern crate request;

use std::error::Error;
use std::io::{self, Write};

fn http_get_main(url: &str) -> Result<(), Box<Error>> {
    // Send the HTTP request and get a response.
    let mut response = request::get(url)?;
    if !response.status().is_success() {
        Err(format!("{}", response.status()))?;
    }

    // Read the response body and write it to stdout.
    let stdout = io::stdout();
    io::copy(&mut response, &mut stdout.lock())?;

    Ok(())
}

fn main() {
    let args: Vec<String> = std::env::args().collect();
    if args.len() != 2 {
        writeln!(io::stderr(), "usage: http-get URL").unwrap();
        return;
    }

    if let Err(err) = http_get_main(&args[1]) {
        writeln!(io::stderr(), "error: {}", err).unwrap();
    }
}
```

The `iron` framework for HTTP servers offers high-level touches such as the `BeforeMiddleware` and `AfterMiddleware` traits, which help you compose an app from pluggable parts. The `websocket` crate implements the WebSocket protocol. And so on. Rust is a young language with a busy open source ecosystem. Support for networking is rapidly expanding.



---

# Concurrency

*In the long run it is not advisable to write large concurrent programs in machine-oriented languages that permit unrestricted use of store locations and their addresses. There is just no way we will be able to make such programs reliable (even with the help of complicated hardware mechanisms).*

—Per Brinch Hansen (1977)

*Patterns for communication are patterns for parallelism.*

—Whit Morriss

If your attitude toward concurrency has changed over the course of your career, you're not alone. It's a common story.

At first, writing concurrent code is easy and fun. The tools—threads, locks, queues, and so on—are a snap to pick up and use. There are a lot of pitfalls, it's true, but fortunately you know what they all are, and you are careful not to make mistakes.

At some point, you have to debug someone else's multithreaded code, and you're forced to conclude that *some* people really should not be using these tools.

Then at some point you have to debug your own multithreaded code.

Experience inculcates a healthy skepticism, if not outright cynicism, toward all multithreaded code. This is helped along by the occasional article explaining in mind-numbing detail why some obviously correct multithreading idiom does not work at all. (It has to do with “the memory model.”) But you eventually find one approach to concurrency that you think you can realistically use without constantly making mistakes. You can shoehorn pretty much everything into that idiom, and (if you're *really* good) you learn to say “no” to added complexity.

Of course, there are rather a lot of idioms. Approaches that systems programmers commonly use include the following:

- A *background thread* that has a single job and periodically wakes up to do it.
- General-purpose *worker pools* that communicate with clients via *task queues*.
- *Pipelines* where data flows from one thread to the next, with each thread doing a little of the work.
- *Data parallelism*, where it is assumed (rightly or wrongly) that the whole computer will mainly just be doing one large computation, which is therefore split into  $n$  pieces and run on  $n$  threads in the hopes of putting all  $n$  of the machine's cores to work at once.
- A *sea of synchronized objects*, where multiple threads have access to the same data, and races are avoided using ad hoc *locking* schemes based on low-level primitives like mutexes. (Java includes built-in support for this model, which was quite popular during the 1990s and 2000s.)
- *Atomic integer operations* allow multiple cores to communicate by passing information through fields the size of one machine word. (This is even harder to get right than all the others, unless the data being exchanged is literally just integer values. In practice, it's usually pointers.)

In time, you may come to be able to use several of these approaches and combine them safely. You are a master of the art. And things would be great, if only nobody else were ever allowed to modify the system in any way. Programs that use threads well are full of unwritten rules.

Rust offers a better way to use concurrency, not by forcing all programs to adopt a single style (which for systems programmers would be no solution at all), but by supporting multiple styles safely. The unwritten rules are written down—in code—and enforced by the compiler.

You've heard that Rust lets you write safe, fast, concurrent programs. This is the chapter where we show you how it's done. We'll cover three ways to use Rust threads:

- Fork-join parallelism
- Channels
- Shared mutable state



Along the way, you're going to use everything you've learned so far about the Rust language. The care Rust takes with references, mutability, and lifetimes is valuable enough in single-threaded programs, but it is in concurrent programming that the true significance of those rules becomes apparent. They make it possible to expand your toolbox, to hack multiple styles of multithreaded code quickly and correctly—without skepticism, without cynicism, without fear.

## Fork-Join Parallelism

The simplest use cases for threads arise when we have several completely independent tasks that we'd like to do at once.

For example, suppose we're doing natural language processing on a large corpus of documents. We could write a loop:

```
fn process_files(filenamees: Vec<String>) -> io::Result<> {  
    for document in filenamees {  
        let text = load(&document)?; // read source file  
        let results = process(text); // compute statistics  
        save(&document, results)?; // write output file  
    }  
    Ok(())  
}
```

The program would run as shown in [Figure 19-1](#).

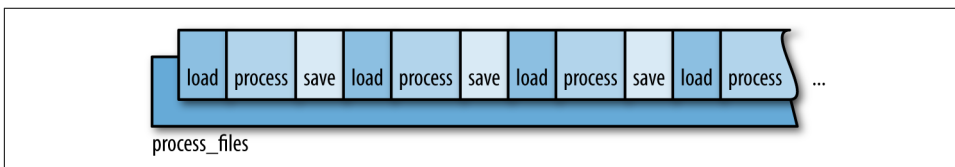

Figure 19-1. Single-threaded execution of `process_files()`

Since each document is processed separately, it's relatively easy to speed this task up by splitting the corpus into chunks and processing each chunk on a separate thread, as shown in [Figure 19-2](#).

This pattern is called *fork-join parallelism*. To *fork* is to start a new thread, and to *join* a thread is to wait for it to finish. We've already seen this technique: we used it to speed up the Mandelbrot program in [Chapter 2](#).

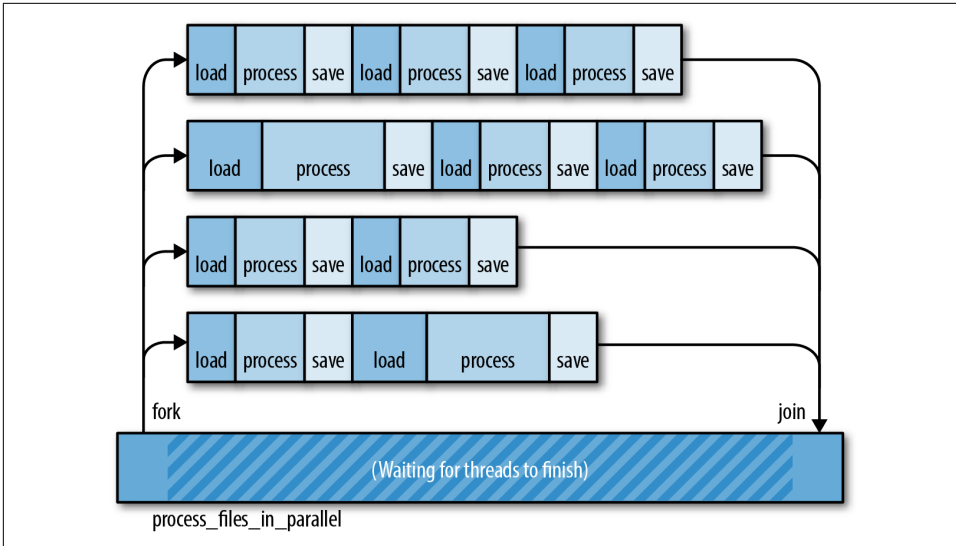

Figure 19-2. Multithreaded file processing using a fork-join approach

Fork-join parallelism is attractive for a few reasons:

- It's dead simple. Fork-join is easy to implement, and Rust makes it easy to get right.
- It avoids bottlenecks. There's no locking of shared resources in fork-join. The only time any thread has to wait for another is at the end. In the meantime, each thread can run freely. This helps keep task-switching overhead low.
- The performance math is straightforward. In the best case, by starting four threads, we can finish our work in a quarter of the time. [Figure 19-2](#) shows one reason we shouldn't expect this ideal speed-up: we might not be able to distribute the work evenly across all threads. Another reason for caution is that sometimes fork-join programs must spend some time after the threads join, *combining* the results computed by the threads. That is, isolating the tasks completely may make some extra work. Still, apart from those two things, any CPU-bound program with isolated units of work can expect a significant boost.
- It's easy to reason about program correctness. A fork-join program is *deterministic* as long as the threads are really isolated, like the compute threads in the Mandelbrot program. The program always produces the same result, regardless of variations in thread speed. It's a concurrency model without race conditions.

The main disadvantage of fork-join is that it requires isolated units of work. Later in this chapter, we'll consider some problems that don't split up so cleanly.

For now, let's stick with the natural language processing example. We'll show a few ways of applying the fork-join pattern to the `process_files` function.

## spawn and join

The function `std::thread::spawn` starts a new thread.

```
spawn(|| {
    println!("hello from a child thread");
})
```

It takes one argument, a `FnOnce` closure or function. Rust starts a new thread to run the code of that closure or function. The new thread is a real operating system thread with its own stack, just like threads in C++, C#, and Java.

Here's a more substantial example, using `spawn` to implement a parallel version of the `process_files` function from before:

```
use std::thread::spawn;

fn process_files_in_parallel(filenamees: Vec<String>) -> io::Result<()> {
    // Divide the work into several chunks.
    const NTHREADS: usize = 8;
    let worklists = split_vec_into_chunks(filenamees, NTHREADS);

    // Fork: Spawn a thread to handle each chunk.
    let mut thread_handles = vec![];
    for worklist in worklists {
        thread_handles.push(
            spawn(move || process_files(worklist))
        );
    }

    // Join: Wait for all threads to finish.
    for handle in thread_handles {
        handle.join().unwrap()?;
    }

    Ok(())
}
```

Let's take this function line by line.

```
fn process_files_in_parallel(filenamees: Vec<String>) -> io::Result<()> {
```

Our new function has the same type signature as the original `process_files`, making it a handy drop-in replacement.

```
    // Divide the work into several chunks.
    const NTHREADS: usize = 8;
    let worklists = split_vec_into_chunks(filenamees, NTHREADS);
```

We use a utility function `split_vec_into_chunks`, not shown here, to divide up the work. The result, `worklists`, is a vector of vectors. It contains eight evenly sized slices of the original vector `filenames`.

```
// Fork: Spawn a thread to handle each chunk.
let mut thread_handles = vec![];
for worklist in worklists {
    thread_handles.push(
        spawn(move || process_files(worklist))
    );
}
```

We spawn a thread for each `worklist`. `spawn()` returns a value called a `JoinHandle`, which we'll use later. For now, we put all the `JoinHandles` into a vector.

Note how we get the list of filenames into the worker thread:

- `worklist` is defined and populated by the `for` loop, in the parent thread.
- As soon as the `move` closure is created, `worklist` is moved into the closure.
- `spawn` then moves the closure (including the `worklist` vector) over to the new child thread.

These moves are cheap. Like the `Vec<String>` moves we discussed in [Chapter 4](#), the `Strings` are not cloned. In fact, nothing is allocated or freed. The only data moved is the `Vec` itself: three machine words.

Most every thread you create needs both code and data to get started. Rust closures, conveniently, contain whatever code you want and whatever data you want.

Moving on:

```
// Join: Wait for all threads to finish.
for handle in thread_handles {
    handle.join().unwrap()?;
}
```

We use the `.join()` method of the `JoinHandles` we collected earlier to wait for all eight threads to finish. Joining threads is often necessary for correctness, because a Rust program exits as soon as `main` returns, even if other threads are still running. Destructors are not called; the extra threads are just killed. If this isn't what you want, be sure to join any threads you care about before returning from `main`.

If we manage to get through this loop, it means all eight child threads finished successfully. Our function therefore ends by returning `Ok(())`:

```
    Ok(())
}
```

## Error Handling Across Threads

The code we used to join the child threads in our example is trickier than it looks, because of error handling. Let's revisit that line of code:

```
handle.join().unwrap()?;
```

The `.join()` method does two neat things for us.

First, `handle.join()` returns a `std::thread::Result` that's an error *if the child thread panicked*. This makes threading in Rust dramatically more robust than in C++. In C++, an out-of-bounds array access is undefined behavior, and there's no protecting the rest of the system from the consequences. In Rust, panic is safe and per thread. The boundaries between threads serve as a firewall for panic; panic doesn't automatically spread from one thread to the threads that depend on it. Instead, a panic in one thread is reported as an error `Result` in other threads. The program as a whole can easily recover.

In our program, though, we don't attempt any fancy panic handling. Instead, we immediately use `.unwrap()` on this `Result`, asserting that it is an `Ok` result and not an `Err` result. If a child thread *did* panic, then this assertion would fail, so the parent thread would panic too. We're explicitly propagating panic from the child threads to the parent thread.

Second, `handle.join()` passes the return value from the child thread back to the parent thread. The closure we passed to `spawn` has a return type of `io::Result<>`, because that's what `process_files` returns. This return value isn't discarded. When the child thread is finished, its return value is saved, and `JoinHandle::join()` transfers that value back to the parent thread.

The full type returned by `handle.join()` in this program is `std::thread::Result<std::io::Result<>>`. The `thread::Result` is part of the `spawn/join` API; the `io::Result` is part of our app.

In our case, after unwrapping the `thread::Result`, we use the `?` operator on the `io::Result`, explicitly propagating I/O errors from the child threads to the parent thread.

All of this may seem rather intricate. But consider that it's just one line of code, and then compare this with other languages. The default behavior in Java and C# is for exceptions in child threads to be dumped to the terminal and then forgotten. In C++, the default is to abort the process. In Rust, errors are `Result` values (data) instead of exceptions (control flow). They're delivered across threads just like any other value. Any time you use low-level threading APIs, you end up having to write careful error-handling code, but *given that you have to write it*, `Result` is very nice to have around.

## Sharing Immutable Data Across Threads

Suppose the analysis we're doing requires a large database of English words and phrases:

```
// before
fn process_files(filenamees: Vec<String>)

// after
fn process_files(filenamees: Vec<String>, glossary: &GigabyteMap)
```

This glossary is going to be big, so we're passing it in by reference. How can we update `process_files_in_parallel` to pass the glossary through to the worker threads?

The obvious change does not work:

```
fn process_files_in_parallel(filenamees: Vec<String>,
                             glossary: &GigabyteMap)
    -> io::Result<()>
{
    ...
    for worklist in worklists {
        thread_handles.push(
            spawn(move || process_files(worklist, glossary)) // error
        );
    }
    ...
}
```

We've simply added a `glossary` argument to our function and passed it along to `process_files`. Rust complains:

```
error[E0477]: the type `[closure@...]` does not fulfill the required lifetime
--> concurrency_spawn_lifetimes.rs:35:13
|
35 |         spawn(move || process_files(worklist, glossary)) // error
|         ^^^^^
|
= note: type must satisfy the static lifetime
```

Rust is complaining about the lifetime of the closure we're passing to `spawn`.

`spawn` launches independent threads. Rust has no way of knowing how long the child thread will run, so it assumes the worst: it assumes the child thread may keep running even after the parent thread has finished and all values in the parent thread are gone. Obviously, if the child thread is going to last that long, the closure it's running needs to last that long too. But this closure has a bounded lifetime: it depends on the reference `glossary`, and references don't last forever.

Note that Rust is right to reject this code! The way we've written this function, it *is* possible for one thread to hit an I/O error, causing `process_files_in_parallel` to

bail out before the other threads are finished. Child threads could end up trying to use the glossary after the main thread has freed it. It would be a race—with undefined behavior as the prize, if the main thread should win. Rust can't allow this.

It seems `spawn` is too open-ended to support sharing references across threads. Indeed, we already saw a case like this, in “[Closures That Steal](#)” on page 306. There, our solution was to transfer ownership of the data to the new thread, using a move closure. That won't work here, since we have many threads that all need to use the same data. One safe alternative is to clone the whole glossary for each thread, but since it's large, we want to avoid that. Fortunately, the standard library provides another way: atomic reference counting.

We described `Arc` in “[Rc and Arc: Shared Ownership](#)” on page 90. It's time to put it to use:

```
use std::sync::Arc;

fn process_files_in_parallel(filenamees: Vec<String>,
                             glossary: Arc<GigabyteMap>)
    -> io::Result<()>
{
    ...
    for worklist in worklists {
        // This call to .clone() only clones the Arc and bumps the
        // reference count. It does not clone the GigabyteMap.
        let glossary_for_child = glossary.clone();
        thread_handles.push(
            spawn(move || process_files(worklist, &glossary_for_child))
        );
    }
    ...
}
```

We have changed the type of `glossary`: to run the analysis in parallel, the caller must pass in an `Arc<GigabyteMap>`, a smart pointer to a `GigabyteMap` that's been moved into the heap, by doing `Arc::new(giga_map)`.

When we call `glossary.clone()`, we are making a copy of the `Arc` smart pointer, not the whole `GigabyteMap`. This amounts to incrementing a reference count.

With this change, the program compiles and runs, because it no longer depends on reference lifetimes. As long as *any* thread owns an `Arc<GigabyteMap>`, it will keep the map alive, even if the parent thread bails out early. There won't be any data races, because data in an `Arc` is immutable.

## Rayon

The standard library's `spawn` function is an important primitive, but it's not designed specifically for fork-join parallelism. Better fork-join APIs have been built on top of it. For example, in [Chapter 2](#) we used the Crossbeam library to split some work across eight threads. Crossbeam's *scoped threads* support fork-join parallelism quite naturally.

The Rayon library, by Niko Matsakis, is another example. It provides two ways of running tasks concurrently:

```
extern crate rayon;
use rayon::prelude::*;

// "do 2 things in parallel"
let (v1, v2) = rayon::join(fn1, fn2);

// "do N things in parallel"
giant_vector.par_iter().for_each(|value| {
    do_thing_with_value(value);
});
```

`rayon::join(fn1, fn2)` simply calls both functions and returns both results. The `.par_iter()` method creates a `ParallelIterator`, a value with `map`, `filter`, and other methods, much like a Rust `Iterator`. In both cases, Rayon uses its own pool of worker threads to spread out the work when possible. You simply tell Rayon what tasks *can* be done in parallel; Rayon manages threads and distributes the work as best it can.

The diagrams in [Figure 19-3](#) illustrate two ways of thinking about the call `giant_vector.par_iter().for_each(...)`. (a) Rayon acts as though it spawns one thread per element in the vector. (b) Behind the scenes, Rayon has one worker thread per CPU core, which is more efficient. This pool of worker threads is shared by all your program's threads. When thousands of tasks come in at once, Rayon divides the work.



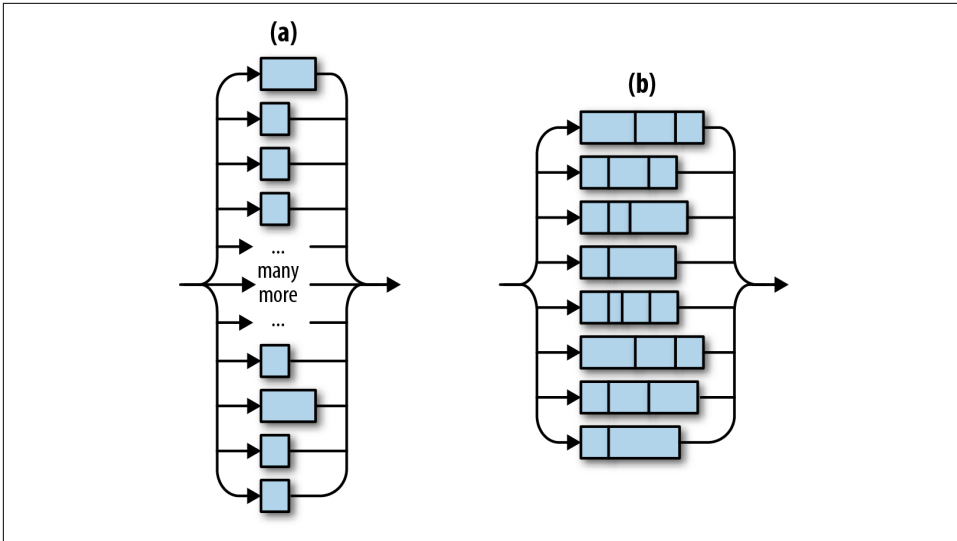

Figure 19-3. Rayon in theory and practice

Here's a version of `process_files_in_parallel` using Rayon:

```
extern crate rayon;

use rayon::prelude::*;

fn process_files_in_parallel(filenamees: Vec<String>, glossary: &GigabyteMap)
    -> io::Result<()>
{
    filenamees.par_iter()
        .map(|filename| process_file(filename, glossary))
        .reduce_with(|r1, r2| {
            if r1.is_err() { r1 } else { r2 }
        })
        .unwrap_or(Ok(()))
}
```

This code is shorter and less tricky than the version using `std::thread::spawn`. Let's look at it line by line:

- First, we use `filenamees.par_iter()` to create a parallel iterator.
- We use `.map()` to call `process_file` on each filename. This produces a `ParallelIterator` over a sequence of `io::Result<()>` values.
- We use `.reduce_with()` to combine the results. Here we're keeping the first error, if any, and discarding the rest. If we wanted to accumulate all the errors, or print them, we could do that here.

The `.reduce_with()` method is also handy when you pass a `.map()` closure that returns a useful value on success. Then you can pass `.reduce_with()` a closure that knows how to combine two success results.

- `reduce_with` returns an `Option` that is `None` only if `filenames` was empty. We use the `Option`'s `.unwrap_or()` method to make the result `Ok(())` in that case.

Behind the scenes, Rayon balances workloads across threads dynamically, using a technique called *work-stealing*. It will typically do a better job keeping all the CPUs busy than we can do by manually dividing the work in advance, as in “[spawn and join](#)” on page 461.

As a bonus, Rayon supports sharing references across threads. Any parallel processing that happens behind the scenes is guaranteed to be finished by the time `reduce_with` returns. This explains why we were able to pass `glossary` to `process_file` even though that closure will be called on multiple threads.

(Incidentally, it's no coincidence that we've used a `map` method and a `reduce` method. The MapReduce programming model, popularized by Google and by Apache Hadoop, has a lot in common with fork-join. It can be seen as a fork-join approach to querying distributed data.)

## Revisiting the Mandelbrot Set

Back in [Chapter 2](#), we used fork-join concurrency to render the Mandelbrot set. This made rendering four times as fast—impressive, but not as impressive as it could be, considering that we had the program spawn eight worker threads and ran it on an eight-core machine!

The problem is that we didn't distribute the workload evenly. Computing one pixel of the image amounts to running a loop (see “[What the Mandelbrot Set Actually Is](#)” on page 24). It turns out that the pale gray parts of the image, where the loop quickly exits, are much faster to render than the black parts, where the loop runs the full 255 iterations. So although we split the area into equal-sized horizontal bands, we were creating unequal workloads, as [Figure 19-4](#) shows.

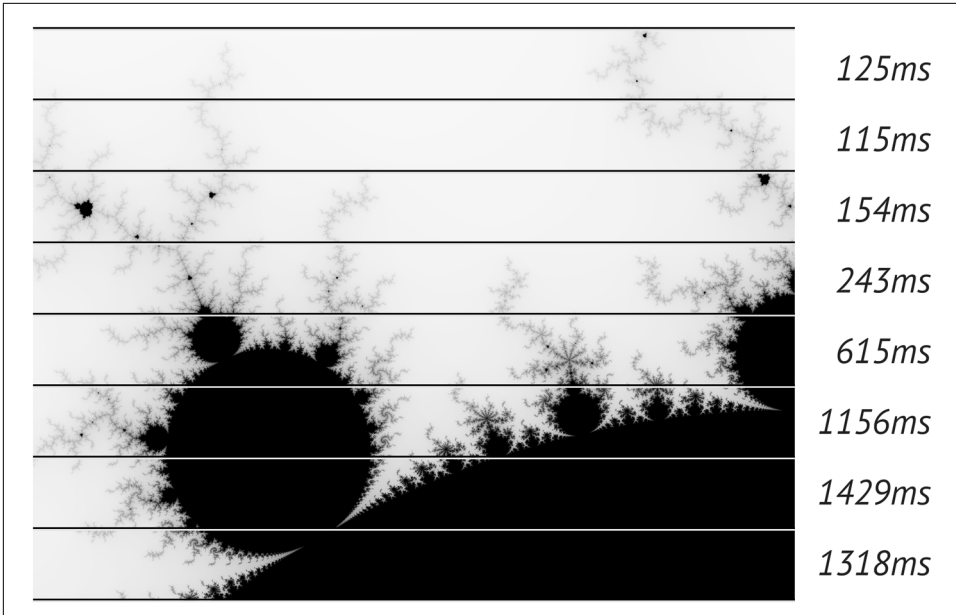

Figure 19-4. Uneven work distribution in the Mandelbrot program

This is easy to fix using Rayon. We can just fire off a parallel task for each row of pixels in the output. This creates several hundred tasks that Rayon can distribute across its threads. Thanks to work-stealing, it won't matter that the tasks vary in size. Rayon will balance the work as it goes.

Here is the code. The first line and the last line are part of the `main` function we showed back in “A Concurrent Mandelbrot Program” on page 35, but we've changed the rendering code, which is everything in between.

```
let mut pixels = vec![0; bounds.0 * bounds.1];

// Scope of slicing up `pixels` into horizontal bands.
{
    let bands: Vec<(usize, &mut [u8])> = pixels
        .chunks_mut(bounds.0)
        .enumerate()
        .collect();

    bands.into_par_iter()
        .weight_max()
        .for_each(|(i, band)| {
            let top = i;
            let band_bounds = (bounds.0, 1);
            let band_upper_left = pixel_to_point(bounds, (0, top),
                upper_left, lower_right);
            let band_lower_right = pixel_to_point(bounds, (bounds.0, top + 1),
```

```

                                upper_left, lower_right);
    render(band, band_bounds, band_upper_left, band_lower_right);
});
}

write_bitmap(&args[1], &pixels, bounds).expect("error writing PNG file");

```

First, we create `bands`, the collection of tasks that we will be passing to Rayon. Each task is just a tuple of type `(usize, &mut [u8])`: the row number, since the computation requires that; and the slice of `pixels` to fill in. We use the `chunks_mut` method to break the image buffer into rows, `enumerate` to attach a row number to each row, and `collect` to slurp all the number-slice pairs into a vector. (We need a vector because Rayon creates parallel iterators only out of arrays and vectors.)

Next, we turn `bands` into a parallel iterator, call `.weight_max()` as a hint to Rayon that these tasks are very CPU-intensive, and then use the `.for_each()` method to tell Rayon what work we want done.

Since we're using Rayon, we must add these lines to `main.rs`:

```

extern crate rayon;
use rayon::prelude::*;

```

and to `Cargo.toml`:

```

[dependencies]
rayon = "0.4"

```

With these changes, the program now uses about 7.75 cores on an 8-core machine. It's 75% faster than before, when we were dividing the work manually. And the code is a little shorter, reflecting the benefits of letting a crate do a job (work distribution) rather than doing it ourselves.

## Channels

A *channel* is a one-way conduit for sending values from one thread to another. In other words, it's a thread-safe queue.

Figure 19-5 illustrates how channels are used. They're something like Unix pipes: one end is for sending data, and the other is for receiving. The two ends are typically owned by two different threads. But whereas Unix pipes are for sending bytes, channels are for sending Rust values. `sender.send(item)` puts a single value into the channel; `receiver.recv()` removes one. Ownership is transferred from the sending thread to the receiving thread. If the channel is empty, `receiver.recv()` blocks until a value is sent.

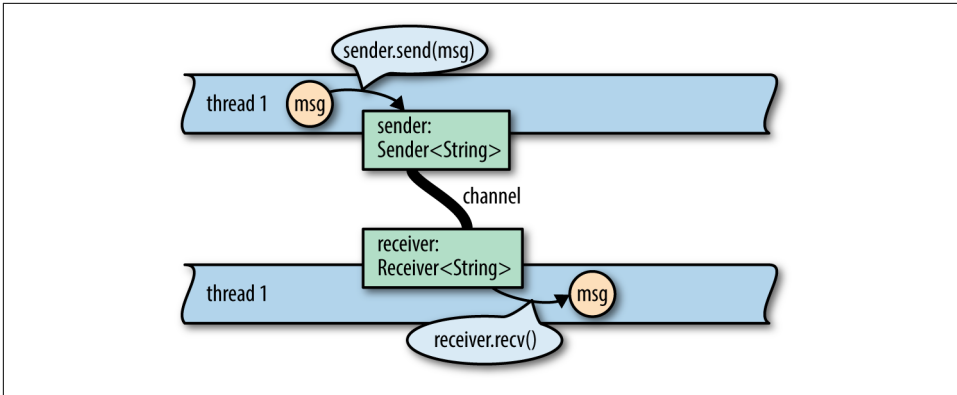

Figure 19-5. A channel for Strings. Ownership of the string `msg` is transferred from thread 1 to thread 2.

With channels, threads can communicate by passing values to one another. It's a very simple way for threads to work together without using locking or shared memory.

This is not a new technique. Erlang has had isolated processes and message passing for 30 years now. Unix pipes have been around for almost 50 years. We tend to think of pipes as providing flexibility and composability, not concurrency, but in fact, they do all of the above. An example of a Unix pipeline is shown in Figure 19-6. It is certainly possible for all three programs to be working at the same time.

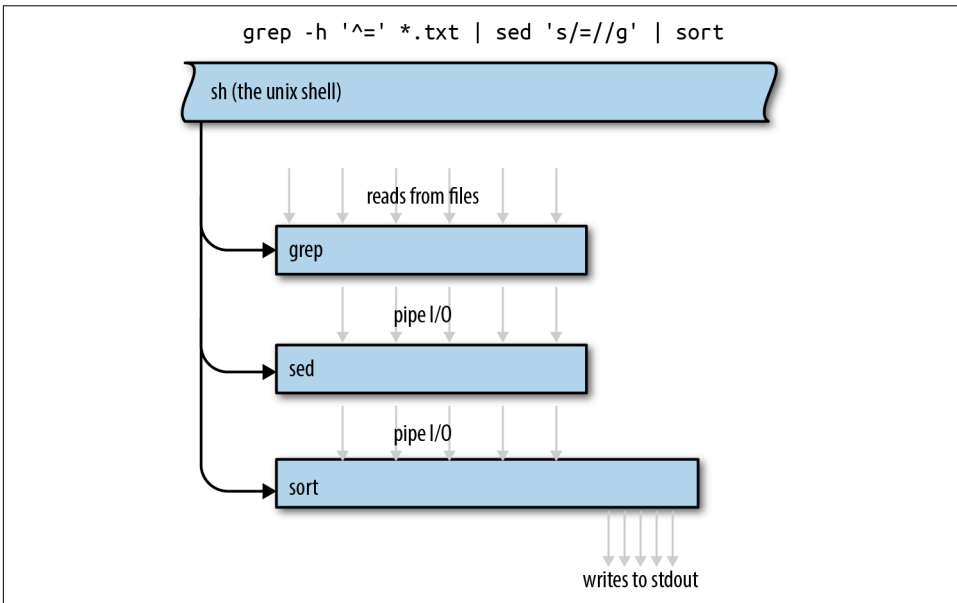

Figure 19-6. Execution of a Unix pipeline

Rust channels are faster than Unix pipes. Sending a value moves it rather than copying it, and moves are fast even when you're moving data structures that contain many megabytes of data.

## Sending Values

Over the next few sections, we'll use channels to build a concurrent program that creates an *inverted index*, one of the key ingredients of a search engine. Every search engine works on a particular collection of documents. The inverted index is the database that tells which words appear where.

We'll show the parts of the code that have to do with threads and channels. The complete program can be found at <https://github.com/ProgrammingRust/fingertips>. It's short, about a thousand lines of code all told.

Our program is structured as a pipeline, as shown in [Figure 19-7](#). Pipelines are only one of the many ways to use channels—we'll discuss a few other uses later—but they're a straightforward way to introduce concurrency into an existing single-threaded program.

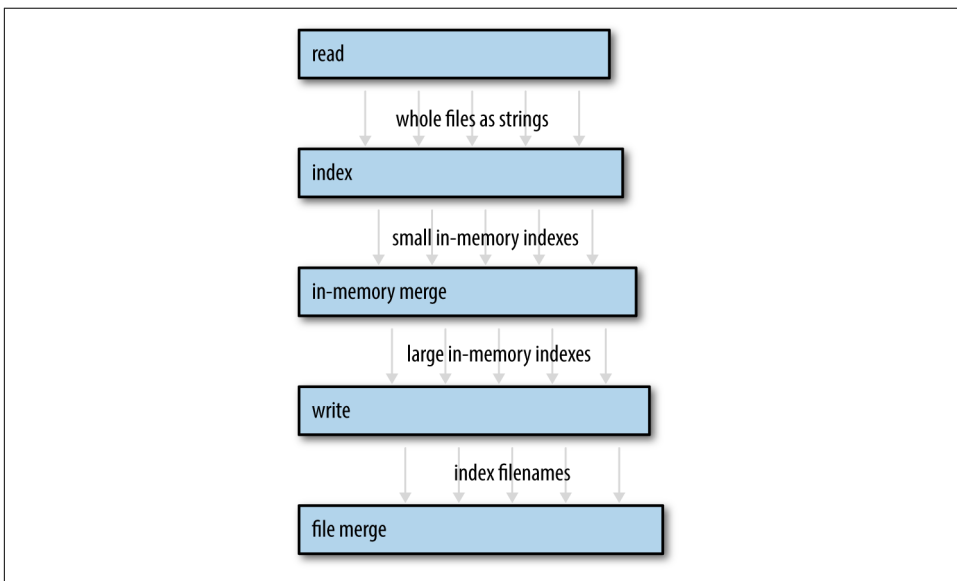

*Figure 19-7. The index builder pipeline. The arrows represent values sent via a channel from one thread to another. Disk I/O is not shown.*

We'll use a total of five threads, each doing a distinct task. Each thread produces output continually over the lifetime of the program. The first thread, for example, simply reads the source documents from disk into memory, one by one. (We want a thread to do this because we'll be writing the simplest possible code here, using `File::open`

and `read_to_string`, which are blocking APIs. We don't want the CPU to sit idle whenever the disk is working.) The output of this stage is one long `String` per document, so this thread is connected to the next thread by a channel of `Strings`.

Our program will begin by spawning the thread that reads files. Suppose `documents` is a `Vec<PathBuf>`, a vector of filenames. The code to start our file-reading thread looks like this:

```
use std::fs::File;
use std::io::prelude::*; // for `Read::read_to_string`
use std::thread::spawn;
use std::sync::mpsc::channel;

let (sender, receiver) = channel();

let handle = spawn(move || {
    for filename in documents {
        let mut f = File::open(filename)?;
        let mut text = String::new();
        f.read_to_string(&mut text)?;

        if sender.send(text).is_err() {
            break;
        }
    }
    Ok(())
});
```

Channels are part of the `std::sync::mpsc` module. We'll explain what this name means later; first, let's look at how this code works. We start by creating a channel:

```
let (sender, receiver) = channel();
```

The `channel` function returns a pair of values: a sender and a receiver. The underlying queue data structure is an implementation detail that the standard library does not expose.

Channels are typed. We're going to use this channel to send the text of each file, so we have a sender of type `Sender<String>` and a receiver of type `Receiver<String>`. We could have explicitly asked for a channel of strings, by writing `channel::<String>()`. Instead, we let Rust's type inference figure it out.

```
let handle = spawn(move || {
```

As before, we're using `std::thread::spawn` to start a thread. Ownership of sender (but not receiver) is transferred to the new thread via this `move` closure.

The next few lines of code simply read files from disk:

```
    for filename in documents {
        let mut f = File::open(filename)?;
```

```
let mut text = String::new();
f.read_to_string(&mut text)?;
```

After successfully reading a file, we send its text into the channel:

```
if sender.send(text).is_err() {
    break;
}
```

`sender.send(text)` moves the value `text` into the channel. Ultimately, it will be moved again to whoever receives the value. Whether `text` contains 10 lines of text or 10 megabytes, this operation copies three machine words (the size of a `String`), and the corresponding `receiver.recv()` call will also copy three machine words.

The `send` and `recv` methods both return `Results`, but these methods fail only if the other end of the channel has been dropped. A `send` call fails if the `Receiver` has been dropped, because otherwise the value would sit in the channel forever: without a `Receiver`, there's no way for any thread to receive it. Likewise, a `recv` call fails if there are no values waiting in the channel and the `Sender` has been dropped, because otherwise `recv` would wait forever: without a `Sender`, there's no way for any thread to send the next value. Dropping your end of a channel is the normal way of “hanging up,” closing the connection when you're done with it.

In our code, `sender.send(text)` will fail only if the receiver's thread has exited early. This is typical for code that uses channels. Whether that happened deliberately or due to an error, it's OK for our reader thread to quietly shut itself down.

When that happens, or the thread finishes reading all the documents, it returns `Ok(())`:

```
Ok(())
});
```

Note that this closure returns a `Result`. If the thread encounters an I/O error, it exits immediately, and the error is stored in the thread's `JoinHandle`.

Of course, just like any other programming language, Rust admits many other possibilities when it comes to error handling. When an error happens, we could just print it out using `println!` and move on to the next file. We could pass errors along via the same channel that we're using for data, making it a channel of `Results`—or create a second channel just for errors. The approach we've chosen here is both lightweight and responsible: we get to use the `?` operator, so there's not a bunch of boilerplate code, or even an explicit `try/catch` as you might see in Java; and yet errors won't pass silently.

For convenience, our program wraps all of this code in a function that returns both the `receiver` (which we haven't used yet) and the new thread's `JoinHandle`:



```

fn start_file_reader_thread(documents: Vec<PathBuf>)
    -> (Receiver<String>, JoinHandle<io::Result<>>())
{
    let (sender, receiver) = channel();

    let handle = spawn(move || {
        ...
    });

    (receiver, handle)
}

```

Note that this function launches the new thread and immediately returns. We'll write a function like this for each stage of our pipeline.

## Receiving Values

Now we have a thread running a loop that sends values. We can spawn a second thread running a loop that calls `receiver.recv()`:

```

while let Ok(text) = receiver.recv() {
    do_something_with(text);
}

```

But `Receivers` are iterable, so there's a nicer way to write this:

```

for text in receiver {
    do_something_with(text);
}

```

These two loops are equivalent. Either way we write it, if the channel happens to be empty when control reaches the top of the loop, the receiving thread will block until some other thread sends a value. The loop will exit normally when the channel is empty and the `Sender` has been dropped. In our program, that happens naturally when the reader thread exits. That thread is running a closure that owns the variable `sender`; when the closure exits, `sender` is dropped.

Now we can write code for the second stage of the pipeline:

```

fn start_file_indexing_thread(texts: Receiver<String>)
    -> (Receiver<InMemoryIndex>, JoinHandle<>())
{
    let (sender, receiver) = channel();

    let handle = spawn(move || {
        for (doc_id, text) in texts.into_iter().enumerate() {
            let index = InMemoryIndex::from_single_document(doc_id, text);
            if sender.send(index).is_err() {
                break;
            }
        }
    });
}

```

```
    (receiver, handle)
}
```

This function spawns a thread that receives `String` values from one channel (`texts`) and sends `InMemoryIndex` values to another channel (`sender/receiver`). This thread's job is to take each of the files loaded in the first stage and turn each document into a little one-file, in-memory inverted index.

The main loop of this thread is straightforward. All the work of indexing a document is done by the function `make_single_file_index`. We won't show its source code here, but it's a simple matter of splitting the input string along word boundaries, and then producing a map from words to lists of positions.

This stage doesn't perform I/O, so it doesn't have to deal with `io::Errors`. Instead of an `io::Result<()>`, it returns `()`.

## Running the Pipeline

The remaining three stages are similar in design. Each one consumes a `Receiver` created by the previous stage. Our goal for the rest of the pipeline is to merge all the small indexes into a single large index file on disk. The fastest way we found to do this is in three stages. We won't show the code here, just the type signatures of these three functions. The full source is online.

First, we merge indexes in memory until they get unwieldy (stage 3):

```
fn start_in_memory_merge_thread(file_indexes: Receiver<InMemoryIndex>)
    -> (Receiver<InMemoryIndex>, JoinHandle<()>)
```

We write these large indexes to disk (stage 4):

```
fn start_index_writer_thread(big_indexes: Receiver<InMemoryIndex>,
                             output_dir: &Path)
    -> (Receiver<PathBuf>, JoinHandle<io::Result<()>>)
```

Finally, if we have multiple large files, we merge them using a file-based merging algorithm (stage 5):

```
fn merge_index_files(files: Receiver<PathBuf>, output_dir: &Path)
    -> io::Result<()>
```

This last stage does not return a `Receiver`, because it's the end of the line. It produces a single output file on disk. It doesn't return a `JoinHandle`, because we don't bother spawning a thread for this stage. The work is done on the caller's thread.

Now we come to the code that launches the threads and checks for errors:

```
fn run_pipeline(documents: Vec<PathBuf>, output_dir: PathBuf)
{
    -> io::Result<()>
```

```

// Launch all five stages of the pipeline.
let (texts, h1) = start_file_reader_thread(documents);
let (pints, h2) = start_file_indexing_thread(texts);
let (gallons, h3) = start_in_memory_merge_thread(pints);
let (files, h4) = start_index_writer_thread(gallons, &output_dir);
let result = merge_index_files(files, &output_dir);

// Wait for threads to finish, holding on to any errors that they encounter.
let r1 = h1.join().unwrap();
h2.join().unwrap();
h3.join().unwrap();
let r4 = h4.join().unwrap();

// Return the first error encountered, if any.
// (As it happens, h2 and h3 can't fail: those threads
// are pure in-memory data processing.)
r1?;
r4?;
result
}

```

As before, we use `.join().unwrap()` to explicitly propagate panics from child threads to the main thread. The only other unusual thing here is that instead of using `?` right away, we set aside the `io::Result` values until we've joined all four threads.

This pipeline is 40% faster than the single-threaded equivalent. That's not bad for an afternoon's work, but paltry-looking next to the 675% boost we got for the Mandelbrot program. We clearly haven't saturated either the system's I/O capacity or all the CPU cores. What's going on?

Pipelines are like assembly lines in a manufacturing plant: performance is limited by the throughput of the slowest stage. A brand-new, untuned assembly line may be as slow as unit production, but assembly lines reward targeted tuning. In our case, measurement shows that the second stage is the bottleneck. Our indexing thread uses `.to_lowercase()` and `.is_alphanumeric()`, so it spends a lot of time poking around in Unicode tables. The other stages downstream from indexing spend most of their time asleep in `Receiver::recv`, waiting for input.

This means we should be able to go faster. As we address the bottlenecks, the degree of parallelism will rise. Now that you know how to use channels and our program is made of isolated pieces of code, it's easy to see ways to address this first bottleneck. We could hand-optimize the code for the second stage, just like any other code; break up the work into two or more stages; or run multiple file-indexing threads at once.

## Channel Features and Performance

The `mpsc` part of `std::sync::mpsc` stands for *multi-producer, single-consumer*, a terse description of the kind of communication Rust’s channels provide.

The channels in our sample program carry values from a single sender to a single receiver. This is a fairly common case. But Rust channels also support multiple senders, in case you need, say, a single thread that handles requests from many client threads, as shown in [Figure 19-8](#).

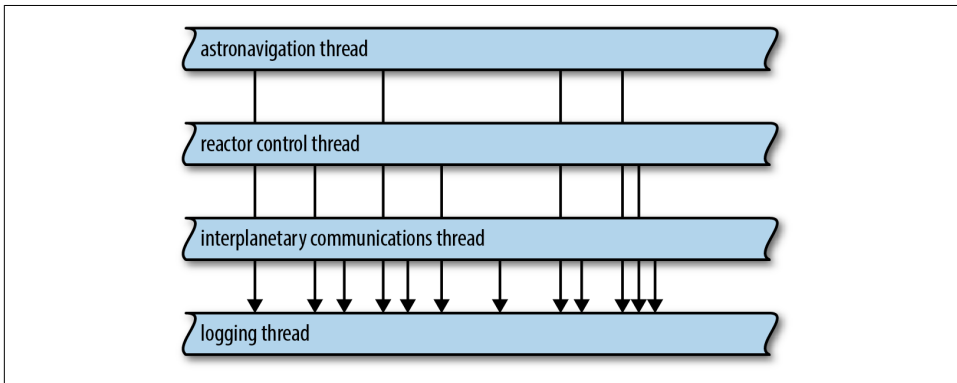

Figure 19-8. A single channel receiving requests from many senders

`Sender<T>` implements the `Clone` trait. To get a channel with multiple senders, simply create a regular channel and clone the sender as many times as you like. You can move each `Sender` value to a different thread.

A `Receiver<T>` can’t be cloned, so if you need to have multiple threads receiving values from the same channel, you need a `Mutex`. We’ll show how to do it later in this chapter.

Rust channels are carefully optimized. When a channel is first created, Rust uses a special “one-shot” queue implementation. If you only ever send one object through the channel, the overhead is minimal. If you send a second value, Rust switches to a different queue implementation. It’s settling in for the long haul, really, preparing the channel to transfer many values while minimizing allocation overhead. And if you clone the `Sender`, Rust must fall back on yet another implementation, one that is safe when multiple threads are trying to send values at once. But even the slowest of these three implementations is a lock-free queue, so sending or receiving a value is at most a few atomic operations and a heap allocation, plus the move itself. System calls are needed only when the queue is empty and the receiving thread therefore needs to put itself to sleep. In this case, of course, traffic through your channel is not maxed out anyway.

Despite all that optimization work, there is one mistake that's very easy for applications to make around channel performance: sending values faster than they can be received and processed. This causes an ever-growing backlog of values to accumulate in the channel. For example, in our program, we found that the file reader thread (stage 1) could load files much faster than the file indexing thread (stage 2) could index them. The result is that hundreds of megabytes of raw data would be read from disk and stuffed in the queue at once.

This kind of misbehavior costs memory and hurts locality. Even worse, the sending thread keeps running, using up CPU and other system resources to send ever more values just when those resources are most needed on the receiving end.

Here Rust again takes a page from Unix pipes. Unix uses an elegant trick to provide some *backpressure*, so that fast senders are forced to slow down: each pipe on a Unix system has a fixed size, and if a process tries to write to a pipe that's momentarily full, the system simply blocks that process until there's room in the pipe. The Rust equivalent is called a *synchronous channel*.

```
use std::sync::mpsc::sync_channel;

let (sender, receiver) = sync_channel(1000);
```

A synchronous channel is exactly like a regular channel except that when you create it, you specify how many values it can hold. For a synchronous channel, `sender.send(value)` is potentially a blocking operation. After all, the idea is that blocking is not always bad. In our example program, changing the channel in `start_file_reader_thread` to a `sync_channel` with room for 32 values cut memory usage by two-thirds on our benchmark data set, without decreasing throughput.

## Thread Safety: Send and Sync

So far we've been acting as though all values can be freely moved and shared across threads. This is mostly true, but Rust's full thread-safety story hinges on two built-in traits, `std::marker::Send` and `std::marker::Sync`.

- Types that implement `Send` are safe to pass by value to another thread. They can be moved across threads.
- Types that implement `Sync` are safe to pass by non-mut reference to another thread. They can be shared across threads.

By *safe* here, we mean the same thing we always mean: free from data races and other undefined behavior.

For example, in the `process_files_in_parallel` example on page 461, we used a closure to pass a `Vec<String>` from the parent thread to each child thread. We didn't point it out at the time, but this means the vector and its strings are allocated in the

parent thread, but freed in the child thread. The fact that `Vec<String>` implements `Send` is an API promise that this is OK: the allocator used internally by `Vec` and `String` is thread-safe.

(If you were to write your own `Vec` and `String` types with fast but non-thread-safe allocators, you'd have to implement them using types that are not `Send`, such as unsafe pointers. Rust would then infer that your `NonThreadSafeVec` and `NonThreadSafeString` types are not `Send` and restrict them to single-threaded use. But that's a rare case.)

As [Figure 19-9](#) illustrates, most types are both `Send` and `Sync`. You don't even have to use `#[derive]` to get these traits on structs and enums in your program. Rust does it for you. A struct or enum is `Send` if its fields are `Send`, and `Sync` if its fields are `Sync`.

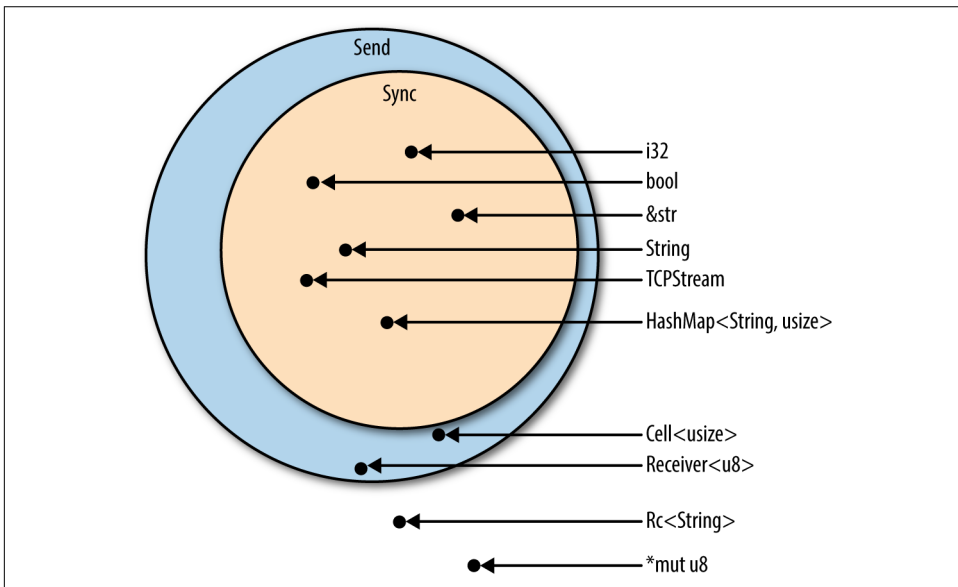

Figure 19-9. `Send` and `Sync` types

The few types that are not `Send` and `Sync` are mostly those that use mutability in a way that isn't thread-safe. For example, consider `std::rc::Rc<T>`, the type of reference-counting smart pointers.

What would happen if you could share an `Rc<String>` across threads? If both threads happen to try to clone the `Rc` at the same time, as shown in [Figure 19-10](#), we have a data race as both threads increment the shared reference count. The reference count could become inaccurate, leading to a use-after-free or double free later—undefined behavior.

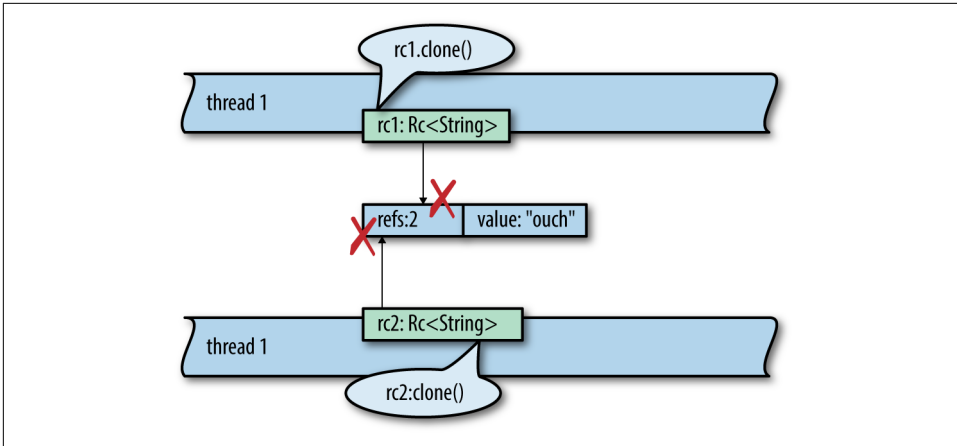

Figure 19-10. Why `Rc<String>` is neither `Sync` nor `Send`

Of course, Rust prevents this. Here's the code to set up this data race:

```
use std::thread::spawn;
use std::rc::Rc;

fn main() {
    let rc1 = Rc::new("hello threads".to_string());
    let rc2 = rc1.clone();
    spawn(move || { // error
        rc2.clone();
    });
    rc1.clone();
}
```

Rust refuses to compile it, giving a detailed error message:

```
error[E0277]: the trait bound `Rc<String>: std::marker::Send` is not satisfied
    in `[closure@...]`
   --> concurrency_send_rc.rs:10:5
    |
10 |     spawn(move || { // error
    |     ^^^^^ within `[closure@...]`, the trait `std::marker::Send` is not
    |         implemented for `Rc<String>`
    |
   = note: `Rc<String>` cannot be sent between threads safely
   = note: required because it appears within the type `[closure@...]`
   = note: required by `std::thread::spawn`
```

Now you can see how `Send` and `Sync` help Rust enforce thread safety. They appear as bounds in the type signature of functions like `spawn` that transfer data across thread boundaries. When you `spawn` a thread, the closure you pass must be `Send`, which means all the values it contains must be `Send`. Similarly, if you try to want to send values through a channel to another thread, the values must be `Send`.

## Piping Almost Any Iterator to a Channel

Our inverted index builder is built as a pipeline. The code is clear enough, but it has us manually setting up channels and launching threads. By contrast, the iterator pipelines we built in [Chapter 15](#) seemed to pack a lot more work into just a few lines of code. Can we build something like that for thread pipelines?

In fact, it would be nice if we could unify iterator pipelines and thread pipelines. Then our index builder could be written as an iterator pipeline. It might start like this:

```
documents.into_iter()
    .map(read_whole_file)
    .errors_to(error_sender) // filter out error results
    .off_thread()           // spawn a thread for the above work
    .map(make_single_file_index)
    .off_thread()           // spawn another thread for stage 2
    ...
```

Traits allow us to add methods to standard library types, so we can actually do this. We start by writing a trait that declares the method we want:

```
use std::sync::mpsc;

pub trait OffThreadExt: Iterator {
    // Transform this iterator into an off-thread iterator: the
    // `next()` calls happen on a separate worker thread, so the
    // iterator and the body of your loop run concurrently.
    fn off_thread(self) -> mpsc::IntoIter<Self::Item>;
}
```

Then we implement this trait for iterator types. It helps that `mpsc::Receiver` is already iterable.

```
use std::thread::spawn;

impl<T> OffThreadExt for T
    where T: Iterator + Send + 'static,
           T::Item: Send + 'static
{
    fn off_thread(self) -> mpsc::IntoIter<Self::Item> {
        // Create a channel to transfer items from the worker thread.
        let (sender, receiver) = mpsc::sync_channel(1024);

        // Move this iterator to a new worker thread and run it there.
        spawn(move || {
            for item in self {
                if sender.send(item).is_err() {
                    break;
                }
            }
        });
    }
}
```



```

        // Return an iterator that pulls values from the channel.
        receiver.into_iter()
    }
}

```

The `where` clause in this code was determined via a process much like the one described in [“Reverse-Engineering Bounds” on page 260](#). At first, we just had this:

```
impl<T: Iterator> OffThreadExt for T
```

That is, we wanted the implementation to work for all iterators. Rust was having none of it. Because we’re using `spawn` to move an iterator of type `T` to a new thread, we must specify `T: Iterator + Send + 'static`. Because we’re sending the items back over a channel, we must specify `T::Item: Send + 'static`. With these changes, Rust was satisfied.

This is Rust’s character in a nutshell: we’re free to add a concurrency power tool to almost every iterator in the language—but not without first understanding and documenting the restrictions that make it safe to use.

## Beyond Pipelines

In this section, we used pipelines as our examples because pipelines are a nice, obvious way to use channels. Everyone understands them. They’re concrete, practical, and deterministic. Channels are useful for more than just pipelines, though. They’re also a quick, easy way to offer any asynchronous service to other threads in the same process.

For example, suppose you’d like to do logging on its own thread, as in [Figure 19-8](#). Other threads could send log messages to the logging thread over a channel; since you can clone the channel’s `Sender`, many client threads can have senders that ship log messages to the same logging thread.

Running a service like logging on its own thread has advantages. The logging thread can rotate log files whenever it needs to. It doesn’t have to do any fancy coordination with the other threads. Those threads won’t be blocked. Messages will accumulate harmlessly in the channel for a moment until the logging thread gets back to work.

Channels can also be used for cases where one thread sends a request to another thread and needs to get some sort of response back. The first thread’s request can be a struct or tuple that includes a `Sender`, a sort of self-addressed envelope that the second thread uses to send its reply. This doesn’t mean the interaction must be synchronous. The first thread gets to decide whether to block and wait for the response or use the `.try_recv()` method to poll for it.

The tools we've presented so far—fork-join for highly parallel computation, channels for loosely connecting components—are sufficient for a wide range of applications. But we're not done.

## Shared Mutable State

In the months since you published the `fern_sim` crate in [Chapter 8](#), your `fern` simulation software has really taken off. Now you're creating a multiplayer real-time strategy game in which eight players compete to grow mostly authentic period ferns in a simulated Jurassic landscape. The server for this game is a massively parallel app, with requests pouring in on many threads. How can these threads coordinate to start a game as soon as eight players are available?

The problem to be solved here is that many threads need access to a shared list of players who are waiting to join a game. This data is necessarily both mutable and shared across all threads. If Rust doesn't have shared mutable state, where does that leave us?

You could solve this by creating a new thread whose whole job is to manage this list. Other threads would communicate with it via channels. Of course, this costs a thread, which has some operating system overhead.

Another option is to use the tools Rust provides for safely sharing mutable data. Such things do exist. They're low-level primitives that will be familiar to any system programmer who's worked with threads. In this section, we'll cover mutexes, read/write locks, condition variables, and atomic integers. Lastly, we'll show how to implement global mutable variables in Rust.

### What Is a Mutex?

A *mutex* (or *lock*) is used to force multiple threads to take turns when accessing certain data. We'll introduce Rust's mutexes in the next section. First, it makes sense to recall what mutexes are like in other languages. A simple use of a mutex in C++ might look like this:

```
// C++ code, not Rust
void FernEngine::JoinWaitingList(PlayerId player) {
    mutex.Acquire();

    waitingList.push_back(player);

    // Start a game if we have enough players waiting.
    if (waitingList.length() >= GAME_SIZE) {
        vector<PlayerId> players;
        waitingList.swap(players);
        StartGame(players);
    }
}
```

```
    mutex.Release();  
}
```

The calls `mutex.Acquire()` and `mutex.Release()` mark the beginning and end of a *critical section* in this code. For each `mutex` in a program, only one thread can be running inside a critical section at a time. If one thread is in a critical section, all other threads that call `mutex.Acquire()` will block until the first thread reaches `mutex.Release()`.

We say that the `mutex` *protects* the data: in this case, `mutex` protects `waitingList`. It is the programmer's responsibility, though, to make sure every thread always acquires the `mutex` before accessing the data, and releases it afterward.

Mutexes are helpful for several reasons:

- They prevent *data races*, situations where racing threads concurrently read and write the same memory. Data races are undefined behavior in C++ and Go. Managed languages like Java and C# promise not to crash, but the results of data races are still (to summarize) nonsense.
- Even if data races didn't exist, even if all reads and writes happened one by one in program order, without a `mutex` the actions of different threads could interleave in arbitrary ways. Imagine trying to write code that works even if other threads modify its data while it's running. Imagine trying to debug it. It would be like your program was haunted.
- Mutexes support programming with *invariants*, rules about the protected data that are true by construction when you set it up and maintained by every critical section.

Of course, all of these are really the same reason: uncontrolled race conditions make programming intractable. Mutexes bring some order to the chaos (though not as much order as channels or fork-join).

However, in most languages, mutexes are very easy to mess up. In C++, as in most languages, the data and the lock are separate objects. Ideally, comments explain that every thread must acquire the `mutex` before touching the data:

```
class FernEmpireApp {  
    ...  
  
private:  
    // List of players waiting to join a game. Protected by `mutex`.  
    vector<PlayerId> waitingList;  
  
    // Lock to acquire before reading or writing `waitingList`.  
    Mutex mutex;
```

```
}; ...
```

But even with such nice comments, the compiler can't enforce safe access here. When a piece of code neglects to acquire the mutex, we get undefined behavior. In practice, this means bugs that are extremely hard to reproduce and fix.

Even in Java, where there is some notional association between objects and mutexes, the relationship does not run very deep. The compiler makes no attempt to enforce it, and in practice, the data protected by a lock is rarely exactly the associated object's fields. It often includes data in several objects. Locking schemes are still tricky. Comments are still the main tool for enforcing them.

## Mutex<T>

Now we'll show an implementation of the waiting list in Rust. In our Fern Empire game server, each player has a unique ID:

```
type PlayerId = u32;
```

The waiting list is just a collection of players:

```
const GAME_SIZE: usize = 8;

/// A waiting list never grows to more than GAME_SIZE players.
type WaitingList = Vec<PlayerId>;
```

The waiting list is stored as a field of the `FernEmpireApp`, a singleton that's set up in an `Arc` during server startup. Each thread has an `Arc` pointing to it. It contains all the shared configuration and other flotsam our program needs. Most of that is read-only. Since the waiting list is both shared and mutable, it must be protected by a `Mutex`:

```
use std::sync::Mutex;

/// All threads have shared access to this big context struct.
struct FernEmpireApp {
    ...
    waiting_list: Mutex<WaitingList>,
    ...
}
```

Unlike C++, in Rust the protected data is stored *inside* the `Mutex`. Setting up the `Mutex` looks like this:

```
let app = Arc::new(FernEmpireApp {
    ...
    waiting_list: Mutex::new(vec![]),
    ...
});
```

Creating a new `Mutex` looks like creating a new `Box` or `Arc`, but while `Box` and `Arc` signify heap allocation, `Mutex` is solely about locking. If you want your `Mutex` to be allocated in the heap, you have to say so, as we've done here by using `Arc::new` for the whole app and `Mutex::new` just for the protected data. These types are commonly used together: `Arc` is handy for sharing things across threads, and `Mutex` is handy for mutable data that's shared across threads.

Now we can implement the `join_waiting_list` method that uses the mutex:

```
impl FernEmpireApp {
    /// Add a player to the waiting list for the next game.
    /// Start a new game immediately if enough players are waiting.
    fn join_waiting_list(&self, player: PlayerId) {
        // Lock the mutex and gain access to the data inside.
        // The scope of `guard` is a critical section.
        let mut guard = self.waiting_list.lock().unwrap();

        // Now do the game logic.
        guard.push(player);
        if guard.len() == GAME_SIZE {
            let players = guard.split_off(0);
            self.start_game(players);
        }
    }
}
```

The only way to get at the data is to call the `.lock()` method:

```
let mut guard = self.waiting_list.lock().unwrap();
```

`self.waiting_list.lock()` blocks until the mutex can be obtained. The `MutexGuard<WaitingList>` value returned by this method call is a thin wrapper around a `&mut WaitingList`. Thanks to deref coercions, discussed [on page 289](#), we can call `WaitingList` methods directly on the guard:

```
guard.push(player);
```

The guard even lets us borrow direct references to the underlying data. Rust's lifetime system ensures those references can't outlive the guard itself. There is no way to access the data in a `Mutex` without holding the lock.

When guard is dropped, the lock is released. Ordinarily that happens at the end of the block, but you can also drop it manually:

```
if guard.len() == GAME_SIZE {
    let players = guard.split_off(0);
    drop(guard); // don't keep the list locked while starting a game
    self.start_game(players);
}
```

## mut and Mutex

It may seem odd—certainly it seemed odd to us at first—that our `join_waiting_list` method doesn't take `self` by `mut` reference. Its type signature is:

```
fn join_waiting_list(&self, player: PlayerId)
```

The underlying collection, `Vec<PlayerId>`, *does* require a `mut` reference when you call its `push` method. Its type signature is:

```
pub fn push(&mut self, item: T)
```

And yet this code compiles and runs fine. What's going on here?

In Rust, `mut` means *exclusive access*. Non-`mut` means *shared access*.

We're used to types passing `mut` access along from the parent to the child, from the container to the contents. You only expect to be able to call `mut` methods on `starships[id].engine` if you have a `mut` reference to `starships` to begin with (or you own `starships`, in which case congratulations on being Elon Musk). That's the default, because if you don't have exclusive access to the parent, Rust generally has no way of ensuring that you have exclusive access to the child.

But `Mutex` does have a way: the lock. In fact, a `mutex` is little more than a way to do exactly this, to provide *exclusive* (`mut`) access to the data inside, even though many threads may have *shared* (non-`mut`) access to the `Mutex` itself.

Rust's type system is telling us what `Mutex` does. It dynamically enforces exclusive access, something that's usually done statically, at compile time, by the Rust compiler.

(You may recall that `std::cell::RefCell` does the same, except without trying to support multiple threads. `Mutex` and `RefCell` are both flavors of interior mutability, which we covered [on page 205](#).)

## Why Mutexes Are Not Always a Good Idea

Before we started on `mutexes`, we presented some approaches to concurrency that might have seemed weirdly easy to use correctly if you're coming from C++. This is no coincidence: these approaches are designed to provide strong guarantees against the most confusing aspects of concurrent programming. Programs that exclusively use `fork-join` parallelism are deterministic and can't deadlock. Programs that use `channels` are almost as well-behaved. Those that use `channels` exclusively for `pipelining`, like our `index builder`, are deterministic: the timing of message delivery can vary, but it won't affect the output. And so on. Guarantees about multithreaded programs are nice!

The design of Rust's `Mutex` will almost certainly have you using mutexes more systematically and more sensibly than you ever have before. But it's worth pausing and thinking about what Rust's safety guarantees can and can't help with.

Safe Rust code cannot trigger a *data race*, a specific kind of bug where multiple threads read and write the same memory concurrently, producing meaningless results. This is great: data races are always bugs, and they are not rare in real multi-threaded programs.

However, threads that use mutexes are subject to some other problems that Rust doesn't fix for you:

- Valid Rust programs can't have data races, but they can still have other *race conditions*—situations where a program's behavior depends on timing among threads and may therefore vary from run to run. Some race conditions are benign. Some manifest as general flakiness and incredibly hard-to-fix bugs. Using mutexes in an unstructured way invites race conditions. It's up to you to make sure they're benign.
- Shared mutable state also affects program design. Where channels serve as an abstraction boundary in your code, making it easy to separate isolated components for testing, mutexes encourage a “just-add-a-method” way of working that can lead to a monolithic blob of interrelated code.
- Lastly, mutexes are just not as simple as they seem at first, as the next two sections will show.

All of these problems are inherent in the tools. Use a more structured approach when you can; use a `Mutex` when you must.

## Deadlock

A thread can deadlock itself by trying to acquire a lock that it's already holding:

```
let mut guard1 = self.waiting_list.lock().unwrap();
let mut guard2 = self.waiting_list.lock().unwrap(); // deadlock
```

Suppose the first call to `self.waiting_list.lock()` succeeds, taking the lock. The second call sees that the lock is held, so it blocks, waiting for it to be released. It will be waiting forever. The waiting thread is the one that's holding the lock.

To put it another way, the lock in a `Mutex` is not a recursive lock.

Here the bug is obvious. In a real program, the two `lock()` calls might be in two different methods, one of which calls the other. The code for each method, taken separately, would look fine. There are other ways to get deadlock, too, involving multiple threads that each acquire multiple mutexes at once. Rust's borrow system can't protect

you from deadlock. The best protection is to keep critical sections small: get in, do your work, and get out.

It's also possible to get deadlock with channels. For example, two threads might block, each one waiting to receive a message from the other. However, again, good program design can give you high confidence that this won't happen in practice. In a pipeline, like our inverted index builder, data flow is acyclic. Deadlock is as unlikely in such a program as in a Unix shell pipeline.

## Poisoned Mutexes

`Mutex::lock()` returns a `Result`, for the same reason that `JoinHandle::join()` does: to fail gracefully if another thread has panicked. When we write `handle.join().unwrap()`, we're telling Rust to propagate panic from one thread to another. The idiom `mutex.lock().unwrap()` is similar.

If a thread panics while holding a `Mutex`, Rust marks the `Mutex` as *poisoned*. Any subsequent attempt to lock the poisoned `Mutex` will get an error result. Our `.unwrap()` call tells Rust to panic if that happens, propagating panic from the other thread to this one.

How bad is it to have a poisoned mutex? Poison sounds deadly, but this scenario is not necessarily fatal. As we said in [Chapter 7](#), panic is safe. One panicking thread leaves the rest of the program in a safe state.

The reason mutexes are poisoned on panic, then, is not for fear of undefined behavior. Rather, the concern is that you've probably been programming with invariants. Since your program panicked and bailed out of a critical section without finishing what it was doing, perhaps having updated some fields of the protected data but not others, it's possible that the invariants are now broken. Rust poisons the mutex to prevent other threads from blundering unwittingly into this broken situation and making it worse. You *can* still lock a poisoned mutex and access the data inside, with mutual exclusion fully enforced; see the documentation for `PoisonError::into_inner()`. But you won't do it by accident.

## Multi-producer Channels Using Mutexes

We mentioned earlier that Rust's channels are multiple-producer, single-consumer. Or to put it more concretely, a channel only has one `Receiver`. We can't have a thread pool where many threads use a single `mpsc` channel as a shared worklist.

However, it turns out there is a very simple workaround, using only standard library pieces. We can add a `Mutex` around the `Receiver` and share it anyway. Here is a module that does so:



```

pub mod shared_channel {
    use std::sync::{Arc, Mutex};
    use std::sync::mpsc::{channel, Sender, Receiver};

    /// A thread-safe wrapper around a `Receiver`.
    #[derive(Clone)]
    pub struct SharedReceiver<T>(Arc<Mutex<Receiver<T>>>);

    impl<T> Iterator for SharedReceiver<T> {
        type Item = T;

        /// Get the next item from the wrapped receiver.
        fn next(&mut self) -> Option<T> {
            let guard = self.0.lock().unwrap();
            guard.recv().ok()
        }
    }

    /// Create a new channel whose receiver can be shared across threads.
    /// This returns a sender and a receiver, just like the stdlib's
    /// `channel()`, and sometimes works as a drop-in replacement.
    pub fn shared_channel<T>() -> (Sender<T>, SharedReceiver<T>) {
        let (sender, receiver) = channel();
        (sender, SharedReceiver(Arc::new(Mutex::new(receiver))))
    }
}

```

We're using an `Arc<Mutex<Receiver<T>>>`. The generics have really piled up. This happens more often in Rust than in C++. It might seem this would get confusing, but often, as in this case, just reading off the names gives the meaning in plain English:

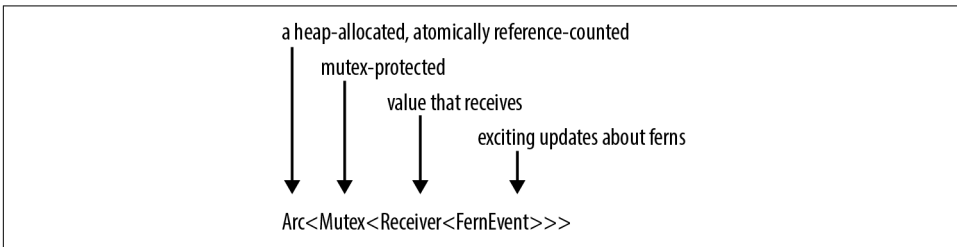

Figure 19-11.

## Read/Write Locks (`RwLock<T>`)

Now let's move on from mutexes to the other thread synchronization tools provided in Rust's standard library toolkit, `std::sync`. We'll move quickly, since a complete discussion of these tools is beyond the scope of this book.

Server programs often have configuration information that is loaded once and rarely ever changes. Most threads only query the configuration, but since the configuration

can change—it may be possible to ask the server to reload its configuration from disk, for example—it must be protected by a lock anyway. In cases like this, a mutex can work, but it’s an unnecessary bottleneck. Threads shouldn’t have to take turns querying the configuration if it’s not changing. This is a case for a *read/write lock*, or `RwLock`.

Whereas a mutex has a single `lock` method, a read/write lock has two locking methods, `read` and `write`. The `RwLock::write` method is like `Mutex::lock`. It waits for exclusive, `mut` access to the protected data. The `RwLock::read` method provides non-`mut` access, with the advantage that it is less likely to have to wait, because many threads can safely read at once. With a mutex, at any given moment, the protected data has only one reader or writer (or none). With a read/write lock, it can have either one writer or many readers, much like Rust references generally.

`FernEmpireApp` might have a struct for configuration, protected by a `RwLock`:

```
use std::sync::RwLock;

struct FernEmpireApp {
    ...
    config: RwLock<AppConfig>,
    ...
}
```

Methods that read the configuration would use `RwLock::read()`:

```
/// True if experimental fungus code should be used.
fn mushrooms_enabled(&self) -> bool {
    let config_guard = self.config.read().unwrap();
    config_guard.mushrooms_enabled
}
```

The method to reload the configuration would use `RwLock::write()`:

```
fn reload_config(&self) -> io::Result<()> {
    let new_config = AppConfig::load()?;
    let mut config_guard = self.config.write().unwrap();
    *config_guard = new_config;
    Ok(())
}
```

Rust, of course, is uniquely well suited to enforce the safety rules on `RwLock` data. The single-writer-or-multiple-reader concept is the core of Rust’s borrow system. `self.config.read()` returns a guard that provides non-`mut` (shared) access to the `AppConfig`; `self.config.write()` returns a different type of guard that provides `mut` (exclusive) access.

## Condition Variables (Condvar)

Often a thread needs to wait until a certain condition becomes true:

- During server shutdown, the main thread may need to wait until all other threads are finished exiting.
- When a worker thread has nothing to do, it needs to wait until there is some data to process.
- A thread implementing a distributed consensus protocol may need to wait until a quorum of peers have responded.

Sometimes, there's a convenient blocking API for the exact condition we want to wait on, like `JoinHandle::join` for the server shutdown example. In other cases, there is no built-in blocking API. Programs can use *condition variables* to build their own. In Rust, the `std::sync::Condvar` type implements condition variables. A `Condvar` has methods `.wait()` and `.notify_all()`; `.wait()` blocks until some other thread calls `.notify_all()`.

There's a bit more to it than that, since a condition variable is always about a particular true-or-false condition about some data protected by a particular `Mutex`. This `Mutex` and the `Condvar` are therefore related. A full explanation is more than we have room for here, but for the benefit of programmers who have used condition variables before, we'll show the two key bits of code.

When the desired condition becomes true, we call `Condvar::notify_all` (or `notify_one`) to wake up any waiting threads:

```
self.has_data_condvar.notify_all();
```

To go to sleep and wait for a condition to become true, we use `Condvar::wait()`:

```
while !guard.has_data() {  
    guard = self.has_data_condvar.wait(guard).unwrap();  
}
```

This `while` loop is a standard idiom for condition variables. However, the signature of `Condvar::wait` is unusual. It takes a `MutexGuard` object by value, consumes it, and returns a new `MutexGuard` on success. This captures the intuition that the `wait` method releases the mutex, then reacquires it before returning. Passing the `MutexGuard` by value is a way of saying, “I bestow upon you, `.wait()` method, my exclusive authority to release the mutex.”

## Atomics

The `std::sync::atomic` module contains atomic types for lock-free concurrent programming. These types are basically the same as Standard C++ atomics:

- `AtomicIsize` and `AtomicUsize` are shared integer types corresponding to the single-threaded `isize` and `usize` types.
- An `AtomicBool` is a shared `bool` value.
- An `AtomicPtr<T>` is a shared value of the unsafe pointer type `*mut T`.

The proper use of atomic data is beyond the scope of this book. Suffice it to say that multiple threads can read and write an atomic value at once without causing data races.

Instead of the usual arithmetic and logical operators, atomic types expose methods that perform *atomic operations*, individual loads, stores, exchanges, and arithmetic operations that happen safely, as a unit, even if other threads are also performing atomic operations that touch the same memory location. Incrementing an `AtomicIsize` named `atom` looks like this:

```
use std::sync::atomic::Ordering;

atom.fetch_add(1, Ordering::SeqCst);
```

These methods may compile to specialized machine language instructions. On the x86-64 architecture, this `.fetch_add()` call compiles to a `lock incq` instruction, where an ordinary `n += 1` might compile to a plain `incq` instruction or any number of variations on that theme. The Rust compiler also has to forgo some optimizations around the atomic operation, since—unlike a normal load or store—it’s legitimately observable by other threads right away.

The argument `Ordering::SeqCst` is a *memory ordering*. Memory orderings are something like transaction isolation levels in a database. They tell the system how much you care about such philosophical notions as causes preceding effects and time not having loops, as opposed to performance. Memory orderings are crucial to program correctness, and they are tricky to understand and reason about. Happily, the performance penalty for choosing sequential consistency, the strictest memory ordering, is often quite low—unlike the performance penalty for putting a SQL database into `SERIALIZABLE` mode. So when in doubt, use `Ordering::SeqCst`. Rust inherits several other memory orderings from Standard C++ atomics, with various weaker guarantees about being and time. We won’t discuss them here.

One simple use of atomics is for cancellation. Suppose we have a thread that’s doing some long-running computation, such as rendering a video, and we would like to be

able to cancel it asynchronously. The problem is to communicate to the thread that we want it to shut down. We can do this via a shared `AtomicBool`:

```
use std::sync::atomic::{AtomicBool, Ordering};

let cancel_flag = Arc::new(AtomicBool::new(false));
let worker_cancel_flag = cancel_flag.clone();
```

This code creates two `Arc<AtomicBool>` smart pointers that point to the same heap-allocated `AtomicBool`, whose initial value is `false`. The first, named `cancel_flag`, will stay in the main thread. The second, `worker_cancel_flag`, will be moved to the worker thread.

Here is the code for the worker:

```
let worker_handle = spawn(move || {
    for pixel in animation.pixels_mut() {
        render(pixel); // ray-tracing - this takes a few microseconds
        if worker_cancel_flag.load(Ordering::SeqCst) {
            return None;
        }
    }
    Some(animation)
});
```

After rendering each pixel, the thread checks the value of the flag by calling its `.load()` method:

```
worker_cancel_flag.load(Ordering::SeqCst)
```

If in the main thread we decide to cancel the worker thread, we store `true` in the `AtomicBool`, then wait for the thread to exit:

```
// Cancel rendering.
cancel_flag.store(true, Ordering::SeqCst);

// Discard the result, which is probably `None`.
worker_handle.join().unwrap();
```

Of course, there are other ways to implement this. The `AtomicBool` here could be replaced with a `Mutex<bool>` or a channel. The main difference is that atomics have minimal overhead. Atomic operations never use system calls. A load or store often compiles to a single CPU instruction.

Atomics are a form of interior mutability, like `Mutex` or `RwLock`, so their methods take self by shared (non-mut) reference. This makes them useful as simple global variables.

## Global Variables

Suppose we are writing networking code. We would like to have a global variable, a counter that we increment every time we serve a packet:

```
/// Number of packets the server has successfully handled.  
static PACKETS_SERVED: usize = 0;
```

This compiles fine. There's just one problem. `PACKETS_SERVED` is not mutable, so we can never change it.

Rust does everything it reasonably can to discourage global mutable state. Constants declared with `const` are, of course, immutable. Static variables are also immutable by default, so there is no way to get a `mut` reference to one. A `static` can be declared `mut`, but then accessing it is unsafe. Rust's insistence on thread safety is a major reason for all of these rules.

Global mutable state also has unfortunate software engineering consequences: it tends to make the various parts of a program more tightly coupled, harder to test, and harder to change later. Still, in some cases there's just no reasonable alternative, so we had better find a safe way to declare mutable static variables.

The simplest way to support incrementing `PACKETS_SERVED`, while keeping it thread-safe, is to make it an atomic integer:

```
use std::sync::atomic::{AtomicUsize, ATOMIC_USIZE_INIT};  
  
static PACKETS_SERVED: AtomicUsize = ATOMIC_USIZE_INIT;
```

The constant `ATOMIC_USIZE_INIT` is an `AtomicUsize` with the value `0`. We use this constant instead of the expression `AtomicUsize::new(0)` because the initial value of a static must be a constant; as of Rust 1.17, method calls are not allowed. Similarly, `ATOMIC_ISIZE_INIT` is an `AtomicIsize` zero, and `ATOMIC_BOOL_INIT` is an `AtomicBool` with the value `false`.

Once this static is declared, incrementing the packet count is straightforward:

```
PACKETS_SERVED.fetch_add(1, Ordering::SeqCst);
```

Atomic globals are limited to simple integers and booleans. Still, creating a global variable of any other type amounts to solving the same two problems, both easy:

- The variable must be made thread-safe somehow, because otherwise it can't be global: for safety, static variables must be both `Sync` and `non-mut`.

Fortunately, we've already seen the solution for this problem. Rust has types for safely sharing values that change: `Mutex`, `RwLock`, and the atomic types. These types can be modified even when declared as `non-mut`. It's what they do. (See [“mut and Mutex” on page 488](#).)

- As mentioned above, static initializers can't call functions. This means that the obvious way to declare a static `Mutex` doesn't work:

```
static HOSTNAME: Mutex<String> =
    Mutex::new(String::new()); // error: function call in static
```

We can use the `lazy_static` crate to get around this problem.

We introduced the `lazy_static` crate in “[Building Regex Values Lazily](#)” on page 426. Defining a variable with the `lazy_static!` macro lets you use any expression you like to initialize it; it runs the first time the variable is dereferenced, and the value is saved for all subsequent uses.

We can declare a global `Mutex` with `lazy_static` like this:

```
#[macro_use] extern crate lazy_static;

use std::sync::Mutex;

lazy_static! {
    static ref HOSTNAME: Mutex<String> = Mutex::new(String::new());
}
```

The same technique works for `RwLock` and `AtomicPtr` variables.

Using `lazy_static!` imposes a tiny performance cost on each access to the static data. The implementation uses `std::sync::Once`, a low-level synchronization primitive designed for one-time initialization. Behind the scenes, each time a lazy static is accessed, the program executes an atomic load instruction to check that initialization has already occurred. (`Once` is rather special-purpose, so we will not cover it in detail here. It is usually more convenient to use `lazy_static!` instead. However, it is handy for initializing non-Rust libraries; for an example, see “[A Safe Interface to libgit2](#)” on page 572.)

## What Hacking Concurrent Code in Rust Is Like

We've shown three techniques for using threads in Rust: fork-join parallelism, channels, and shared mutable state with locks. Our aim has been to provide a good introduction to the pieces Rust provides, with a focus on how they can fit together into real programs.

Rust insists on safety, so from the moment you decide to write a multithreaded program, the focus is on building safe, structured communication. Keeping threads mostly isolated is a good way to convince Rust that what you're doing is safe. It happens that isolation is also a good way to make sure what you're doing is correct and maintainable. Again, Rust guides you toward good programs.

More important, Rust lets you combine techniques and experiment. You can iterate fast: arguing with the compiler gets you up and running correctly a lot faster than debugging data races.



*A cento (pronounced “cento,” from the Latin for “patchwork”) is a poem made up entirely of lines quoted from another poet.*

—Matt Madden

*Your quote here.*

—Bjarne Stroustrup

Rust supports *macros*, a way to extend the language in ways that go beyond what you can do with functions alone. For example, we’ve seen the `assert_eq!` macro, which is handy for tests:

```
assert_eq!(gcd(6, 10), 2);
```

This could have been written as a generic function, but the `assert_eq!` macro does several things that functions can’t do. One is that when an assertion fails, `assert_eq!` generates an error message containing the filename and line number of the assertion. Functions have no way of getting that information. Macros can, because the way they work is completely different.

Macros are a kind of shorthand. During compilation, before types are checked and long before any machine code is generated, each macro call is *expanded*—that is, it’s replaced with some Rust code. The preceding macro call expands to this:

```
match (&gcd(6, 10), &2) {
  (left_val, right_val) => {
    if !(*left_val == *right_val) {
      panic!("assertion failed: `(left == right)`, \
        (left: `{:?}`, right: `{:?}`)", left_val, right_val);
    }
  }
}
```

`panic!` is also a macro, so it then expands to some more Rust code. That code uses two other macros, `file!()` and `line!()`. Once every macro call in the crate is fully expanded, Rust moves on to the next phase of compilation.

At run time, an assertion failure would look like this (and would indicate a bug in the `gcd()` function, since 2 is the correct answer):

```
thread 'main' panicked at 'assertion failed: `(left == right)`', (left: `17`,
right: `2`)', gcd.rs:7
```

If you're coming from C++, you may have had some bad experiences with macros. Rust macros take a different approach, similar to Scheme's `syntax-rules`. Compared to C++ macros, Rust macros are better integrated with the rest of the language and therefore less error prone. Macro calls are always marked with an exclamation point, so they stand out when you're reading code, and they can't be called accidentally when you meant to call a function. Rust macros never insert unmatched brackets or parentheses. And Rust macros come with pattern matching, making it easier to write macros that are both maintainable and appealing to use.

In this chapter, we'll show how to write macros using several examples. Then we'll dig into how macros work, because like much of Rust, the tool rewards deep understanding. Lastly, we'll see what we can do when simple pattern matching is not enough.

## Macro Basics

Figure 20-1 shows part of the source code for the `assert_eq!` macro.

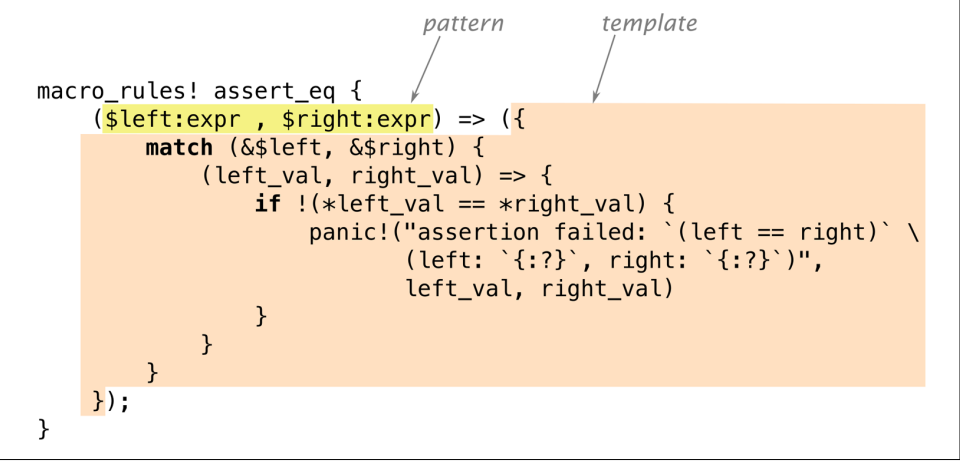

```
macro_rules! assert_eq {
    ($left:expr, $right:expr) => ({
        match (&$left, &$right) {
            (left_val, right_val) => {
                if !(*left_val == *right_val) {
                    panic!("assertion failed: `(left == right)` \
                        (left: `{:?}`, right: `{:?}`)",
                        left_val, right_val)
                }
            }
        }
    });
}
```

Figure 20-1. The `assert_eq!` macro

`macro_rules!` is the main way to define macros in Rust. Note that there is no `!` after `assert_eq` in this macro definition: the `!` is only included when calling a macro, not when defining it.

Not all macros are defined this way: a few, like `file!`, `line!`, and `macro_rules!` itself, are built into the compiler, and we'll talk about another approach, called procedural macros, at the end of this chapter. But for the most part, we'll focus on `macro_rules!`, which is (so far) the easiest way to write your own.

A macro defined with `macro_rules!` works entirely by pattern matching. The body of a macro is just a series of rules:

```
( pattern1 ) => ( template1 );  
( pattern2 ) => ( template2 );  
...
```

The version of `assert_eq!` in [Figure 20-1](#) has just one pattern and one template.

Incidentally, you can use square brackets or curly braces instead of parentheses around the pattern or the template; it makes no difference to Rust. Likewise, when you call a macro, these are all equivalent:

```
assert_eq!(gcd(6, 10), 2);  
assert_eq![gcd(6, 10), 2];  
assert_eq!{gcd(6, 10), 2}
```

The only difference is that semicolons are usually optional after curly braces. By convention, we use parentheses when calling `assert_eq!`, square brackets for `vec!`, and curly braces for `macro_rules!`; but it's just a convention.

## Basics of Macro Expansion

Rust expands macros very early during compilation. The compiler reads your source code from beginning to end, defining and expanding macros as it goes. You can't call a macro before it is defined, because Rust expands each macro call before it even looks at the rest of the program. (By contrast, functions and other `items` don't have to be in any particular order. It's OK to call a function that won't be defined until later in the crate.)

When Rust expands an `assert_eq!` macro call, what happens is a lot like evaluating a `match` expression. Rust first matches the arguments against the pattern, as shown in [Figure 20-2](#).

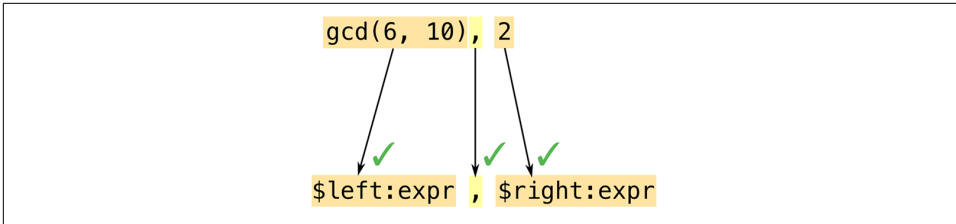

Figure 20-2. Expanding a macro, part 1: pattern matching on the arguments

Macro patterns are a mini-language within Rust. They’re essentially regular expressions for matching code. But where regular expressions operate on characters, patterns operate on *tokens*—the numbers, names, punctuation marks, and so forth that are the building blocks of Rust programs. This means you can use comments and whitespace freely in macro patterns to make them as readable as possible. Comments and whitespace aren’t tokens, so they don’t affect matching.

Another important difference between regular expressions and macro patterns is that parentheses, brackets, and braces always occur in matched pairs in Rust. This is checked before macros are expanded, not only in macro patterns but throughout the language.

In this example, our pattern contains `$left:expr`, which tells Rust to match an expression (in this case, `gcd(6, 10)`) and assign it the name `$left`. Rust then matches the comma in the pattern with the comma following `gcd`’s arguments. Just like regular expressions, patterns have only a few special characters that trigger interesting matching behavior; everything else, like this comma, has to match verbatim or else matching fails. Lastly, Rust matches the expression `2` and gives it the name `$right`.

Both code fragments in this pattern are of type `expr`: they expect expressions. We’ll see other types of code fragments in “[Fragment Types](#)” on page 510.

Since this pattern matched all of the arguments, Rust expands the corresponding *template* ([Figure 20-3](#)).

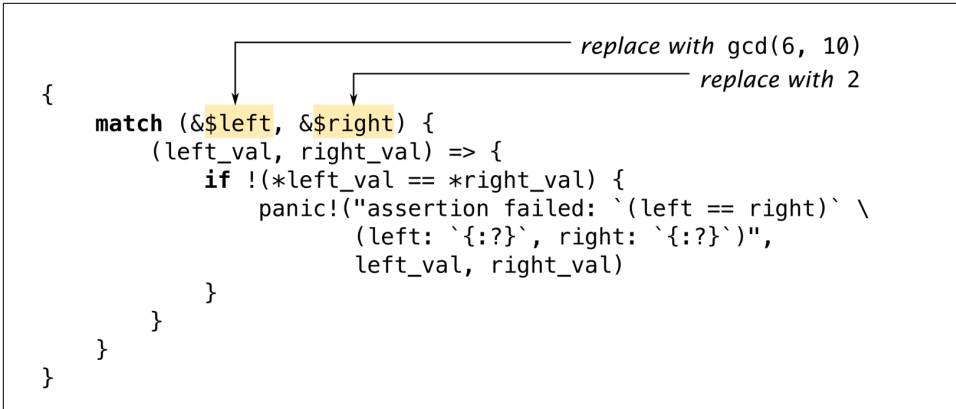

Figure 20-3. Expanding a macro, part 2: filling in the template

Rust replaces `$left` and `$right` with the code fragments it found during matching.

It's a common mistake to include the fragment type in the output template: writing `$left:expr` rather than just `$left`. Rust does not immediately detect this kind of error. It sees `$left` as a substitution, and then it treats `:expr` just like everything else in the template: tokens to be included in the macro's output. So the errors won't happen until you *call* the macro; then it will generate bogus output that won't compile. If you get error messages like `expected type, found `:`` when using a new macro, check it for this mistake. (“[Debugging Macros](#)” on page 508 offers more general advice for situations like this.)

Macro templates aren't much different from any of a dozen template languages commonly used in web programming. The only difference—and it's a significant one—is that the output is Rust code.

## Unintended Consequences

Plugging fragments of code into templates is subtly different from regular code that works with values. These differences aren't always obvious at first. The macro we've been looking at, `assert_eq!`, contains some slightly strange bits of code for reasons that say a lot about macro programming. Let's look at two funny bits in particular.

First, why does this macro create the variables `left_val` and `right_val`? Is there some reason we can't simplify the template to look like this?

```

if !($left == $right) {
  panic!("assertion failed: `(left == right)` \
    (left: `{:?}`, right: `{:?}`)", $left, $right)
}

```

To answer this question, try mentally expanding the macro call `assert_eq!(letters.pop(), Some('z'))`. What would the output be? Naturally, Rust would plug the matched expressions into the template in multiple places. It seems like a bad idea to evaluate the expressions all over again when building the error message, though, and not just because it would take twice as long: since `letters.pop()` removes a value from a vector, it'll produce a different value the second time we call it! That's why the real macro computes `$left` and `$right` only once and stores their values.

Moving on to the second question: why does this macro borrow references to the values of `$left` and `$right`? Why not just store the values in variables, like this?

```
macro_rules! bad_assert_eq {
    ($left:expr, $right:expr) => ({
        match ($left, $right) {
            (left_val, right_val) => {
                if !(left_val == right_val) {
                    panic!("assertion failed" /* ... */);
                }
            }
        }
    });
}
```

For the particular case we've been considering, where the macro arguments are integers, this would work fine. But if the caller passed, say, a `String` variable as `$left` or `$right`, this code would move the value out of the variable!

```
fn main() {
    let s = "a rose".to_string();
    bad_assert_eq!(s, "a rose");
    println!("confirmed: {} is a rose", s); // error: use of moved value "s"
}
```

Since we don't want assertions to move values, the macro borrows references instead.

(You may have wondered why the macro uses `match` rather than `let` to define the variables. We wondered too. It turns out there's no particular reason for this. `let` would have been equivalent.)

In short, macros can do surprising things. If strange things happen around a macro you've written, it's a good bet that the macro is to blame.

One bug that you *won't* see is this classic C++ macro bug:

```
// buggy C++ macro to add 1 to a number
#define ADD_ONE(n) n + 1
```

For reasons familiar to most C++ programmers, and not worth explaining fully here, unremarkable code like `ADD_ONE(1) * 10` or `ADD_ONE(1 << 4)` produces very sur-

prising results with this macro. To fix it, you'd add more parentheses to the macro definition. This isn't necessary in Rust, because Rust macros are better integrated with the language. Rust knows when it's handling expressions, so it effectively adds parentheses whenever it pastes one expression into another.

## Repetition

The standard `vec!` macro comes in two forms:

```
// Repeat a value N times
let buffer = vec![0_u8; 1000];

// A list of values, separated by commas
let numbers = vec!["udon", "ramen", "soba"];
```

It can be implemented like this:

```
macro_rules! vec {
  ($elem:expr ; $n:expr) => {
    ::std::vec::from_elem($elem, $n)
  };
  ($( $x:expr ),* ) => {
    <[_]>::into_vec(Box::new([ $( $x ),* ]))
  };
  ($( $x:expr ),+ ,) => {
    vec! [ $( $x ),* ]
  };
}
```

There are three rules here. We'll explain how multiple rules work and then look at each rule in turn.

When Rust expands a macro call like `vec![1, 2, 3]`, it starts by trying to match the arguments `1, 2, 3` with the pattern for the first rule, in this case `$elem:expr ; $n:expr`. This fails to match: `1` is an expression, but the pattern requires a semicolon after that, and we don't have one. So Rust then moves on to the second rule, and so on. If no rules match, it's an error.

The first rule handles uses like `vec![0u8; 1000]`. It happens that there is a standard function, `std::vec::from_elem`, that does exactly what's needed here, so this rule is straightforward.

The second rule handles `vec!["udon", "ramen", "soba"]`. The pattern, `$( $x:expr ),*`, uses a feature we haven't seen before: repetition. It matches 0 or more expressions, separated by commas. More generally, the syntax `$( PATTERN ),*` is used to match any comma-separated list, where each item in the list matches `PATTERN`.

The `*` here has the same meaning as in regular expressions (“0 or more”) although admittedly regexps do not have a special `,*` repeater. You can also use `+` to require at least one match. There is no `?` syntax. The following table gives the full suite of repetition patterns:

Pattern	Meaning
<code>\$( ... )*</code>	Match 0 or more times with no separator
<code>\$( ... ),*</code>	Match 0 or more times, separated by commas
<code>\$( ... );*</code>	Match 0 or more times, separated by semicolons
<code>\$( ... )+</code>	Match 1 or more times with no separator
<code>\$( ... ),+</code>	Match 1 or more times, separated by commas
<code>\$( ... );+</code>	Match 1 or more times, separated by semicolons

The code fragment `$x` is not just a single expression but a list of expressions. The template for this rule uses repetition syntax too:

```
<[_]>::into_vec(Box::new([ $( $x ),* ]))
```

Again, there are standard methods that do exactly what we need. This code creates a boxed array, and then uses the `[T]::into_vec` method to convert the boxed array to a vector.

The first bit, `<[_]>`, is an unusual way to write the type “slice of something”, while expecting Rust to infer the element type. Types whose names are plain identifiers can be used in expressions without any fuss, but types like `fn()`, `&str`, or `[_]` must be wrapped in angle brackets.

Repetition comes in at the end of the template, where we have `$( $x ),*`. This `$( ... ),*` is the same syntax we saw in the pattern. It iterates over the list of expressions that we matched for `$x` and inserts them all into the template, separated by commas.

In this case, the repeated output looks just like the input. But that doesn’t have to be the case. We could have written the rule like this:

```
( $( $x:expr ),* ) => {
    {
        let mut v = Vec::new();
        $( v.push($x); )*
        v
    }
};
```



Here, the part of the template that reads `$( v.push($x); )*` inserts a call to `v.push()` for each expression in `$x`.

Unlike the rest of Rust, patterns using `$( ... ),*` do not automatically support an optional trailing comma. However, there's a standard trick for supporting trailing commas by adding an extra rule. That is what the third rule of our `vec!` macro does:

```
( $( $x:expr ),+ , ) => { // if trailing comma is present,
    vec![ $( $x ),* ]    // retry without it
};
```

We use `$( ... ),+ ,` to match a list with an extra comma. Then, in the template, we call `vec!` recursively, leaving the extra comma out. This time the second rule will match.

## Built-In Macros

The Rust compiler supplies several macros that are helpful when you're defining your own macros. None of these could be implemented using `macro_rules!` alone. They're hardcoded in `rustc`:

- **file!()** expands to a string literal: the current filename. **line!()** and **column!()** expand to `u32` literals giving the current line (counting from 1) and column (counting from 0).

If one macro calls another, which calls another, all in different files, and the last macro calls `file!()`, `line!()`, or `column!()`, it will expand to indicate the location of the *first* macro call.

- **stringify!(...tokens...)** expands to a string literal containing the given tokens. The `assert!` macro uses this to generate an error message that includes the code of the assertion.

Macro calls in the argument are *not* expanded: `stringify!(line!())` expands to the string `"line!()"`.

Rust constructs the string from the tokens, so there are no line breaks or comments in the string.

- **concat!(str0, str1, ...)** expands to a single string literal made by concatenating its arguments.

Rust also defines these macros for querying the build environment:

- **cfg!(...)** expands to a Boolean constant, `true` if the current build configuration matches the condition in parentheses. For example, `cfg!(debug_assertions)` is `true` if you're compiling with debug assertions enabled.

This macro supports exactly the same syntax as the `#[cfg(...)]` attribute described in “Attributes” on page 175 but instead of conditional compilation, you get a true or false answer.

- `env!("VAR_NAME")` expands to a string: the value of the specified environment variable at compile time. If the variable doesn't exist, it's a compilation error.

This would be fairly worthless except that Cargo sets several interesting environment variables when it compiles a crate. For example, to get your crate's current version string, you can write:

```
let version = env!("CARGO_PKG_VERSION");
```

A full list of these environment variables is included in the [Cargo documentation](#).

- `option_env!("VAR_NAME")` is the same as `env!` except that it returns an `Option<'static str>` that is `None` if the specified variable is not set.

Three more built-in macros let you bring in code or data from another file.

- `include!("file.rs")` expands to the contents of the specified file, which must be valid Rust code—either an expression or a sequence of items.
- `include_str!("file.txt")` expands to a `&'static str` containing the text of the specified file. You can use it like this:

```
const COMPOSITOR_SHADER: &str =  
    include_str!("../resources/compositor.glsl");
```

If the file doesn't exist, or is not valid UTF-8, you'll get a compilation error.

- `include_bytes!("file.dat")` is the same except the file is treated as binary data, not UTF-8 text. The result is a `&'static [u8]`.

Like all macros, these are processed at compile time. If the file doesn't exist or can't be read, compilation fails. They can't fail at run time. In all cases, if the filename is a relative path, it's resolved relative to the directory that contains the current file.

## Debugging Macros

Debugging a wayward macro can be challenging. The biggest problem is the lack of visibility into the process of macro expansion. Rust will often expand all macros, find some kind of error, and then print an error message that does not show the fully expanded code that contains the error!

Here are three tools to help troubleshoot macros. (These features are all unstable, but since they're really designed to be used during development, not in code that you'd check in, that isn't a big problem in practice.)

First and simplest, you can ask `rustc` to show what your code looks like after expanding all macros. Use `cargo build --verbose` to see how Cargo is invoking `rustc`. Copy the `rustc` command line and add `-Z unstable-options --pretty expanded` as options. The fully expanded code is dumped to your terminal. Unfortunately, this only works if your code is free of syntax errors.

Second, Rust provides a `log_syntax!()` macro that simply prints its arguments to the terminal at compile time. You can use this for `println!`-style debugging. This macro requires the `#![feature(log_syntax)]` feature flag.

Third, you can ask the Rust compiler to log all macro calls to the terminal. Insert `trace_macros!(true);` somewhere in your code. From that point on, each time Rust expands a macro, it will print the macro name and arguments. For example, this program:

```
#![feature(trace_macros)]

fn main() {
    trace_macros!(true);
    let numbers = vec![1, 2, 3];
    trace_macros!(false);
    println!("total: {}", numbers.iter().sum::<u64>());
}
```

produces this output:

```
$ rustup override set nightly
...
$ rustc trace_example.rs
note: trace_macro
--> trace_example.rs:5:19
|
5 |     let numbers = vec![1, 2, 3];
|                          ^^^^^^^^^^^^^^^^^
|
= note: expanding `vec! { 1 , 2 , 3 }`
= note: to `< [ _ ] > :: into_vec ( box [ 1 , 2 , 3 ] )`
```

The compiler shows the code of each macro call, both before and after expansion. The line `trace_macros!(false);` turns tracing off again, so the call to `println!()` is not traced.

## The json! Macro

We've now discussed the core features of `macro_rules!`. In this section, we'll incrementally develop a macro for building JSON data. We'll use this example to show what it's like to develop a macro, present the few remaining pieces of `macro_rules!`, and offer some advice on how to make sure your macros behave as desired.

Back in [Chapter 10](#), we presented this enum for representing JSON data:

```
#[derive(Clone, PartialEq, Debug)]
enum Json {
    Null,
    Boolean(bool),
    Number(f64),
    String(String),
    Array(Vec<Json>),
    Object(Box<HashMap<String, Json>>)
}
```

The syntax for writing out `Json` values is unfortunately rather verbose:

```
let students = Json::Array(vec![
    Json::Object(Box::new(vec![
        ("name".to_string(), Json::String("Jim Blandy".to_string())),
        ("class_of".to_string(), Json::Number(1926.0)),
        ("major".to_string(), Json::String("Tibetan throat singing".to_string()))
    ]).into_iter().collect()),
    Json::Object(Box::new(vec![
        ("name".to_string(), Json::String("Jason Orendorff".to_string())),
        ("class_of".to_string(), Json::Number(1702.0)),
        ("major".to_string(), Json::String("Knots".to_string()))
    ]).into_iter().collect())
]);
```

We would like to be able to write this using a more JSON-like syntax:

```
let students = json!([
    {
        "name": "Jim Blandy",
        "class_of": 1926,
        "major": "Tibetan throat singing"
    },
    {
        "name": "Jason Orendorff",
        "class_of": 1702,
        "major": "Knots"
    }
]);
```

What we want is a `json!` macro that takes a JSON value as an argument and expands to a Rust expression like the one in the previous example.

## Fragment Types

The first job in writing any complex macro is figuring out how to match, or *parse*, the desired input.

We can already see that the macro will have several rules, because there are several different sorts of things in JSON data: objects, arrays, numbers, and so forth. In fact, we might guess that we'll have one rule for each JSON type:

```
macro_rules! json {
    (null) => { Json::Null };
    ([ ... ]) => { Json::Array(...) };
    ({ ... }) => { Json::Object(...) };
    (???) => { Json::Boolean(...) };
    (???) => { Json::Number(...) };
    (???) => { Json::String(...) };
}
```

This is not quite correct, as macro patterns offer no way to tease apart the last three cases; but we'll see how to deal with that later on. The first three cases, at least, clearly begin with different tokens, so let's start with those.

The first rule already works:

```
macro_rules! json {
    (null) => {
        Json::Null
    }
}

#[test]
fn json_null() {
    assert_eq!(json!(null), Json::Null); // passes!
}
```

To add support for JSON arrays, we might try matching the elements as exprs:

```
macro_rules! json {
    (null) => {
        Json::Null
    };
    ([ $( $element:expr ),* ]) => {
        Json::Array(vec![ $( $element ),* ])
    };
}
```

Unfortunately, this does not match all JSON arrays. Here's a test that illustrates the problem:

```
#[test]
fn json_array_with_json_element() {
    let macro_generated_value = json!(
        [
            // valid JSON that doesn't match `$(element):expr`
            {
                "pitch": 440.0
            }
        ]
    );
    let hand_coded_value =
        Json::Array(vec![
            Json::Object(Box::new(vec![
                ("pitch".to_string(), Json::Number(440.0))
            ]))
        ])
}
```

```

        ].collect()))
    });
    assert_eq!(macro_generated_value, hand_coded_value);
}

```

The pattern `$(element:expr),*` means “a comma-separated list of Rust expressions.” But many JSON values, particularly objects, aren’t valid Rust expressions. They won’t match.

Since not every bit of code you want to match is an expression, Rust supports several other fragment types, listed in [Table 20-1](#).

*Table 20-1. Fragment types supported by macro\_rules!*

Fragment type	Matches (with examples)	Can be followed by...
<code>expr</code>	An expression: <code>2 + 2, "udon", x.len()</code>	<code>=&gt; , ;</code>
<code>stmt</code>	An expression or declaration, not including any trailing semicolon (hard to use; try <code>expr</code> or <code>block</code> instead)	<code>=&gt; , ;</code>
<code>ty</code>	A type: <code>String, Vec&lt;u8&gt;, (&amp;str, bool)</code>	<code>=&gt; , ; =   { [ : &gt;</code> as where
<code>path</code>	A path (discussed <a href="#">on page 167</a> ): <code>ferns, ::std::sync::mpsc</code>	<code>=&gt; , ; =   { [ : &gt;</code> as where
<code>pat</code>	A pattern (discussed <a href="#">on page 221</a> ): <code>_ , Some(ref x)</code>	<code>=&gt; , =   if in</code>
<code>item</code>	An item (discussed <a href="#">on page 126</a> ): <code>struct Point { x: f64, y: f64 }, mod ferns;</code>	Anything
<code>block</code>	A block (discussed <a href="#">on page 124</a> ): <code>{ s += "ok\n"; true }</code>	Anything
<code>meta</code>	The body of an attribute (discussed <a href="#">on page 175</a> ): <code>inline, derive(Copy, Clone), doc="3D models."</code>	Anything
<code>ident</code>	An identifier: <code>std, Json, longish_variable_name</code>	Anything
<code>tt</code>	A token tree (see text): <code>;, &gt;=, {}, [0 1 (+ 0 1)]</code>	Anything

Most of the options in this table strictly enforce Rust syntax. The `expr` type matches only Rust expressions (not JSON values), `ty` matches Rust types, and so on. They’re not extensible: there’s no way to define new arithmetic operators or new keywords

that `expr` would recognize. We won't be able to make any of these match arbitrary JSON data.

The last two, `ident` and `tt`, support matching macro arguments that don't look like Rust code. `ident` matches any identifier. `tt` matches a single *token tree*: either a properly matched pair of brackets, `(...)` `[...]` or `{...}`, and everything in between, including nested token trees; or a single token that isn't a bracket, like `1926` or `"Knots"`.

Token trees are exactly what we need for our `json!` macro. Every JSON value is a single token tree: numbers, strings, Boolean values, and `null` are all single tokens; objects and arrays are bracketed. So we can write the patterns like this:

```
macro_rules! json {
  (null) => {
    Json::Null
  };
  ([ $( $element:tt ),* ]) => {
    Json::Array(...)
  };
  ({ $( $key:tt : $value:tt ),* }) => {
    Json::Object(...)
  };
  ($other:tt) => {
    ... // TODO: Return Number, String, or Boolean
  };
}
```

This version of the `json!` macro can match all JSON data. Now we just need to produce correct Rust code.

To make sure Rust can gain new syntactic features in the future without breaking any macros you write today, Rust restricts tokens that appear in patterns right after a fragment. The “Can be followed by...” column of [Table 20-1](#) shows which tokens are allowed. For example, the pattern `$x:expr ~ $y:expr` is an error, because `~` isn't allowed after an `expr`. The pattern `$vars:pat : $t:ty` is OK, because `$vars:pat` is followed by a colon, one of the allowed tokens for a `pat`; and `$t:ty` is followed by nothing, which is always allowed.

## Recursion in Macros

You've already seen one trivial case of a macro calling itself: our implementation of `vec!` uses recursion to support trailing commas. Here we can show a more significant example: `json!` needs to call itself recursively.

We might try supporting JSON arrays without using recursion, like this:

```
([ $( $element:tt ),* ]) => {
    Json::Array(vec![ $( $element ),* ])
};
```

But this wouldn't work. We'd be pasting JSON data (the `$element` token trees) right into a Rust expression. They're two different languages.

We need to convert each element of the array from JSON form to Rust. Fortunately, there's a macro that does this: the one we're writing!

```
([ $( $element:tt ),* ]) => {
    Json::Array(vec![ $( json!($element) ),* ])
};
```

Objects can be supported in the same way:

```
({ $( $key:tt : $value:tt ),* }) => {
    Json::Object(Box::new(vec![
        $( ( $key.to_string(), json!($value) ) ),*
    ].into_iter().collect()))
};
```

The compiler imposes a recursion limit on macros: 64 calls, by default. That's more than enough for normal uses of `json!`, but complex recursive macros sometimes hit the limit. You can adjust it by adding this attribute at the top of the crate where the macro is used:

```
#![recursion_limit = "256"]
```

Our `json!` macro is nearly complete. All that remains is to support Boolean, number, and string values.

## Using Traits with Macros

Writing complex macros always poses puzzles. It's important to remember that macros themselves are not the only puzzle-solving tool at your disposal.

Here, we need to support `json!(true)`, `json!(1.0)`, and `json!("yes")`, converting the value, whatever it may be, to the appropriate kind of `Json` value. But macros are not good at distinguishing types. We can imagine writing:

```
macro_rules! json {
    (true) => {
        Json::Boolean(true)
    };
    (false) => {
        Json::Boolean(false)
    };
    ...
}
```



This approach breaks down right away. There are only two Boolean values, but rather more numbers than that, and even more strings.

Fortunately, there is a standard way to convert values of various types to one specified type: the `From` trait, covered [on page 297](#). We simply need to implement this trait for a few types:

```
impl From<bool> for Json {
    fn from(b: bool) -> Json {
        Json::Boolean(b)
    }
}

impl From<i32> for Json {
    fn from(i: i32) -> Json {
        Json::Number(i as f64)
    }
}

impl From<String> for Json {
    fn from(s: String) -> Json {
        Json::String(s)
    }
}

impl<'a> From<&'a str> for Json {
    fn from(s: &'a str) -> Json {
        Json::String(s.to_string())
    }
}
...

```

In fact, all 12 numeric types should have very similar implementations, so it might make sense to write a macro, just to avoid the copy-and-paste:

```
macro_rules! impl_from_num_for_json {
    ( $( $t:ident )* ) => {
        $(
            impl From<$t> for Json {
                fn from(n: $t) -> Json {
                    Json::Number(n as f64)
                }
            }
        )*
    };
}

impl_from_num_for_json!(u8 i8 u16 i16 u32 i32 u64 i64 usize isize f32 f64);

```

Now we can use `Json::from(value)` to convert a value of any supported type to `Json`. In our macro, it'll look like this:

```

($other:tt) => {
    Json::from($other) // Handle Boolean/number/string
};

```

Adding this rule to our `json!` macro makes it pass all the tests we've written so far. Putting together all the pieces, it currently looks like this:

```

macro_rules! json {
    (null) => {
        Json::Null
    };
    ([ $($element:tt),* ]) => {
        Json::Array(vec![ $( json!($element) ),* ])
    };
    ({ $($key:tt : $value:tt),* }) => {
        Json::Object(Box::new(vec![
            $( ($key.to_string(), json!($value)) ),*
        ].into_iter().collect()))
    };
    ($other:tt) => {
        Json::from($other) // Handle Boolean/number/string
    };
}

```

As it turns out, the macro unexpectedly supports the use of variables and even arbitrary Rust expressions inside the JSON data, a handy extra feature:

```

let width = 4.0;
let desc =
    json!({
        "width": width,
        "height": (width * 9.0 / 4.0)
    });

```

Because `(width * 9.0 / 4.0)` is parenthesized, it's a single token tree, so the macro successfully matches it with `$value:tt` when parsing the object.

## Scoping and Hygiene

A surprisingly tricky aspect of writing macros is that they involve pasting code from different scopes together. So the next few pages cover the two ways Rust handles scoping: one way for local variables and arguments, and another way for everything else.

To show why this matters, let's rewrite our rule for parsing JSON objects (the third rule in the `json!` macro shown previously) to eliminate the temporary vector. We can write it like this:

```

({ $($key:tt : $value:tt),* }) => {
    {
        let mut fields = Box::new(HashMap::new());
        $( fields.insert($key.to_string(), json!($value)); )*
    }
}

```

```

        Json::Object(fields)
    }
};

```

Now we're populating the `HashMap` not by using `collect()` but by repeatedly calling the `.insert()` method. This means we need to store the map in a temporary variable, which we've called `fields`.

But then what happens if the code that calls `json!` happens to use a variable of its own, also named `fields`?

```

let fields = "Fields, W.C.";
let role = json!({
    "name": "Larson E. Whipsnade",
    "actor": fields
});

```

Expanding the macro would paste together two bits of code, both using the name `fields` for different things!

```

let fields = "Fields, W.C.";
let role = {
    let mut fields = Box::new(HashMap::new());
    fields.insert("name".to_string(), Json::from("Larson E. Whipsnade"));
    fields.insert("actor".to_string(), Json::from(fields));
    Json::Object(fields)
};

```

This may seem like an unavoidable pitfall whenever macros use temporary variables, and you may already be thinking through the possible fixes. Perhaps we should rename the variable that the `json!` macro defines to something that its callers aren't likely to pass in: instead of `fields`, we could call it `__json$fields`.

The surprise here is that *the macro works as is*. Rust renames the variable for you! This feature, first implemented in Scheme macros, is called *hygiene*, and so Rust is said to have *hygienic macros*.

The easiest way to understand macro hygiene is to imagine that every time a macro is expanded, the parts of the expansion that come from the macro itself are painted a different color.

Variables of different colors, then, are treated as if they had different names:

```
let fields = "Fields, W.C.";
let role = {
    let mut fields = Box::new(HashMap::new());
    fields.insert("name".to_string(), Json::from("Larson E. Whipsnade"));
    fields.insert("actor".to_string(), Json::from(fields));
    Json::Object(fields)
};
```

Note that bits of code that were passed in by the macro caller and pasted into the output, such as "name" and "actor", keep their original color (black). Only tokens that originate from the macro template are painted.

Now there's one variable named `fields` (declared in the caller) and a separate variable named `fields` (introduced by the macro). Since the names are different colors, the two variables don't get confused.

If a macro really does need to refer to a variable in the caller's scope, the caller has to pass the name of the variable to the macro.

(The paint metaphor isn't meant to be an exact description of how hygiene works. The real mechanism is even a little smarter than that, recognizing two identifiers as the same, regardless of "paint," if they refer to a common variable that's in scope for both the macro and its caller. But cases like this are rare in Rust. If you understand the preceding example, you know enough to use hygienic macros.)

You may have noticed that many other identifiers were painted one or more colors as the macros were expanded: `Box`, `HashMap`, and `Json`, for example. Despite the paint, Rust had no trouble recognizing these type names. That's because hygiene in Rust is limited to local variables and arguments. When it comes to constants, types, methods, modules, and macro names, Rust is "colorblind."

This means that if our `json!` macro is used in a module where `Box`, `HashMap`, or `Json` is not in scope, the macro won't work. We'll show how to avoid this problem in the next section.

First, we'll consider a case where Rust's strict hygiene gets in the way, and we need to work around it. Suppose we have many functions that contain this line of code:

```
let req = ServerRequest::new(server_socket.session());
```

Copying and pasting that line is a pain. Can we use a macro instead?

```
macro_rules! setup_req {
    () => {
        let req = ServerRequest::new(server_socket.session());
    }
}
```

```
fn handle_http_request(server_socket: &ServerSocket) {
    setup_req!(); // declares `req`, uses `server_socket`
    ... // code that uses `req`
}
```

As written, this doesn't work. It would require the name `server_socket` in the macro to refer to the local `server_socket` declared in the function, and vice versa for the variable `req`. But hygiene prevents names in macros from “colliding” with names in other scopes—even in cases like this, where that's what you want.

The solution is to pass the macro any identifiers you plan on using both inside and outside the macro code:

```
macro_rules! setup_req {
    ($req:ident, $server_socket:ident) => {
        let $req = ServerRequest::new($server_socket.session());
    }
}

fn handle_http_request(server_socket: &ServerSocket) {
    setup_req!(req, server_socket);
    ... // code that uses `req`
}
```

Since `req` and `server_socket` are now provided by the function, they're the right “color” for that scope.

Hygiene makes this macro a little wordier to use, but that's a feature, not a bug: it's easier to reason about hygienic macros knowing that they can't mess with local variables behind your back. If you search for an identifier like `server_socket` in a function, you'll find all the places where it's used, including macro calls.

## Importing and Exporting Macros

Since macros are expanded early in compilation, before Rust knows the full module structure of your project, they aren't imported and exported in the usual way.

Within a single crate:

- Macros that are visible in one module are automatically visible in its child modules.
- To export macros from a module “upward” to its parent module, use the `#[macro_use]` attribute. For example, suppose our `lib.rs` looks like this:

```
#[macro_use] mod macros;
mod client;
mod server;
```

All macros defined in the `macros` module are imported into `lib.rs` and therefore visible throughout the rest of the crate, including in `client` and `server`.

When working with multiple crates:

- To import macros from another crate, use `#[macro_use]` on the `extern crate` declaration.
- To export macros from your crate, mark each public macro with `#[macro_export]`.

Of course, actually doing any of these things means your macro may be called in other modules. An exported macro therefore shouldn't rely on anything being in scope—there's no telling what will be in scope where it's used. Even features of the standard prelude can be shadowed.

Instead, the macro should use absolute paths to any names it uses. `macro_rules!` provides the special fragment `crate` to help with this. It acts like an absolute path to the root module of the crate where the macro was defined. Instead of saying `Json`, we can write `crate::Json`, which works even if `Json` was not imported. `HashMap` can be changed to either `::std::collections::HashMap` or `crate::macros::HashMap`. In the latter case, we'll have to re-export `HashMap`, because `crate` can't be used to access private features of a crate. It really just expands to something like `::jsonlib`, an ordinary path. Visibility rules are unaffected.

After moving the macro to its own module `macros` and modifying it to use `crate`, it looks like this. This is the final version.

```
// macros.rs
pub use std::collections::HashMap;
pub use std::boxed::Box;
pub use std::string::ToString;

#[macro_export]
macro_rules! json {
    (null) => {
        crate::Json::Null
    };
    ([ $( $element:tt ),* ]) => {
        crate::Json::Array(vec![ $( json!( $element ) ),* ])
    };
    ({ $( $key:tt : $value:tt ),* }) => {
        {
            let mut fields = crate::macros::Box::new(
                crate::macros::HashMap::new());
            $( fields.insert(crate::ToString::to_string($key), json!($value)); )*
            crate::Json::Object(fields)
        }
    };
};
```

```

    ($other:tt) => {
        $crate::Json::from($other)
    };
}

```

Since the `.to_string()` method is part of the standard `ToString` trait, we use `$crate` to refer to that as well, using syntax we introduced in “Fully Qualified Method Calls” on page 252: `$crate::ToString::to_string($key)`. In our case, this isn’t strictly necessary to make the macro work, because `ToString` is in the standard prelude. But if you’re calling methods of a trait that may not be in scope at the point where the macro is called, a fully qualified method call is the best way to do it.

## Avoiding Syntax Errors During Matching

The following macro seems reasonable, but it gives Rust some trouble:

```

macro_rules! complain {
    ($msg:expr) => {
        println!("Complaint filed: {}", $msg);
    };
    (user : $userid:tt , $msg:expr) => {
        println!("Complaint from user {}: {}", $userid, $msg);
    };
}

```

Suppose we call it like this:

```
complain!(user: "jimb", "the AI lab's chatbots keep picking on me");
```

To human eyes, this obviously matches the second pattern. But Rust tries the first rule first, attempting to match all of the input with `$msg:expr`. This is where things start to go badly for us. `user: "jimb"` is not an expression, of course, so we get a syntax error. Rust refuses to sweep a syntax error under the rug—macros are already hard enough to debug. Instead, it’s reported immediately and compilation halts.

If any other token in a pattern fails to match, Rust moves on the next rule. Only syntax errors are fatal, and they only happen when trying to match fragments.

The problem here is not so hard to understand: we’re attempting to match a fragment, `$msg:expr`, in the wrong rule. It’s not going to match because we’re not even supposed to be here. The caller wanted the other rule. There are two easy ways to avoid this.

First, avoid confusable rules. We could, for example, change the macro so that every pattern starts with a different identifier:

```

macro_rules! complain {
    (msg : $msg:expr) => {
        println!("Complaint filed: {}", $msg);
    };
}

```

```

    (user : $userid:tt , msg : $msg:expr) => {
        println!("Complaint from user {}: {}", $userid, $msg);
    };
}

```

When the macro arguments start with `msg`, we'll get rule 1. When they start with `user`, we'll get rule 2. Either way, we know we've got the right rule before we try to match a fragment.

The other way to avoid spurious syntax errors is by putting more specific rules first. Putting the `user:` rule first fixes the problem with `complain!`, because the rule that causes the syntax error is never reached.

## Beyond `macro_rules!`

Macro patterns can parse input that's even more intricate than JSON, but we've found that the complexity quickly gets out of hand.

*The Little Book of Rust Macros*, by Daniel Keep et al., is an excellent handbook of advanced `macro_rules!` programming. The book is clear and smart, and it describes every aspect of macro expansion in more detail than we have here. It also presents several very clever techniques for pressing `macro_rules!` patterns into service as a sort of esoteric programming language, to parse complex input. This we're less enthusiastic about. Use with care.

Rust 1.15 introduced a separate mechanism called *procedural macros*. This feature supports extending the `#[derive]` attribute to handle custom traits, as shown in [Figure 20-4](#).

```

#[derive(Copy, Clone, PartialEq, Eq, IntoJson)]
struct Money {
    dollars: u32,
    cents: u16,
}

```

*custom derive* ↙

Figure 20-4. Invoking a hypothetical `IntoJson` procedural macro via a `#[derive]` attribute

There is no `IntoJson` trait, but it doesn't matter: a procedural macro can use this hook to insert whatever code it wants (in this case, probably `impl From<Money> for Json { ... }`).

What makes a procedural macro “procedural” is that it's implemented as a Rust function, not a declarative rule-set. As of this writing, procedural macros are still new and expected to continue evolving, so we refer you to the [online documentation](#).



Perhaps, having read all this, you've decided that you hate macros. What then? An alternative is to generate Rust code using a build script. The [Cargo documentation](#) shows how to do it step by step. It involves writing a program that generates the Rust code you want, adding a line to *Cargo.toml* to run that program as part of the build process, and using `include!` to get the generated code into your crate.



---

# Unsafe Code

*Let no one think of me that I am humble or weak or passive;  
Let them understand I am of a different kind:  
dangerous to my enemies, loyal to my friends.  
To such a life glory belongs.*

—Euripides, *Medea*

The secret joy of systems programming is that, underneath every single safe language and carefully designed abstraction is a swirling maelstrom of wildly unsafe machine language and bit-fiddling. You can write that in Rust, too.

The language we've presented up to this point in the book ensures your programs are free of memory errors and data races entirely automatically, through types, lifetimes, bounds checks, and so on. But this sort of automated reasoning has its limits; there are many valuable techniques that Rust cannot recognize as safe.

*Unsafe code* lets you tell Rust, “In this case, just trust me.” By marking off a block or function as unsafe, you acquire the ability to call `unsafe` functions in the standard library, dereference unsafe pointers, and call functions written in other languages like C and C++, among other powers. All of Rust's usual safety checks still apply: type checks, lifetime checks, and bounds checks on indices all occur normally. Unsafe code just enables a small set of additional features.

This ability to step outside the boundaries of safe Rust is what makes it possible to implement many of Rust's most fundamental features in Rust itself, as is commonly done in C and C++ systems. Unsafe code is what allows the `Vec` type to manage its buffer efficiently; the `std::io` module to talk to the operating system; and the `std::thread` and `std::sync` modules to provide concurrency primitives.

This chapter covers the essentials of working with unsafe features:

- Rust’s unsafe blocks establish the boundary between ordinary, safe Rust code and code that uses unsafe features.
- You can mark functions as `unsafe`, alerting callers to the presence of extra contracts they must follow to avoid undefined behavior.
- Raw pointers and their methods allow unconstrained access to memory, and let you build data structures Rust’s type system would otherwise forbid.
- Understanding the definition of undefined behavior will help you appreciate why it can have consequences far more serious than just getting incorrect results.
- Rust’s foreign function interface lets you use libraries written in other languages.
- Unsafe traits, analogous to unsafe functions, impose a contract that each implementation (rather than each caller) must follow.

## Unsafe from What?

At the start of this book, we showed a C program that crashes in a surprising way because it fails to follow one of the rules prescribed by the C standard. You can do the same in Rust:

```
$ cat crash.rs
fn main() {
    let mut a: usize = 0;
    let ptr = &mut a as *mut usize;
    unsafe {
        *ptr.offset(3) = 0x7ffff72f484c;
    }
}
$ cargo build
   Compiling unsafe-samples v0.1.0
   Finished debug [unoptimized + debuginfo] target(s) in 0.44 secs
$ ../../target/debug/crash
crash: Error: .netrc file is readable by others.
crash: Remove password or make file unreadable by others.
Segmentation fault (core dumped)
$
```

This program borrows a mutable reference to the local variable `a`, casts it to a raw pointer of type `*mut usize`, and then uses the `offset` method to produce a pointer three words further along in memory. This happens to be where `main`’s return address is stored. The program overwrites the return address with a constant, such that returning from `main` behaves in a surprising way. What makes this crash possible is the program’s incorrect use of unsafe features—in this case, the ability to dereference raw pointers.

An unsafe feature is one that imposes a *contract*: rules that Rust cannot enforce automatically, but which you must nonetheless follow to avoid *undefined behavior*.

A contract goes beyond the usual type checks and lifetime checks, imposing further rules specific to that unsafe feature. Typically, Rust itself doesn't know about the contract at all; it's just explained in the feature's documentation. For example, the raw pointer type has a contract forbidding you to dereference a pointer that has been advanced beyond the end of its original referent. The expression `*ptr.offset(3) = ...` in this example breaks this contract. But, as the transcript shows, Rust compiles the program without complaint: its safety checks do not detect this violation. When you use unsafe features, you, as the programmer, bear the responsibility for checking that your code adheres to their contracts.

Lots of features have rules you should follow to use them correctly, but such rules are not contracts in the sense we mean here unless the possible consequences include undefined behavior. Undefined behavior is behavior Rust firmly assumes your code could never exhibit. For example, Rust assumes you will not overwrite a function call's return address with something else. Code that passes Rust's usual safety checks and complies with the contracts of the unsafe features it uses cannot possibly do such a thing. Since the program violates the raw pointer contract, its behavior is undefined, and it goes off the rails.

If your code exhibits undefined behavior, you have broken your half of your bargain with Rust, and Rust declines to predict the consequences. Dredging up irrelevant error messages from the depths of system libraries and crashing is one possible consequence; handing control of your computer over to an attacker is another. The effects could vary from one release of Rust to the next, without warning. Sometimes, however, undefined behavior has no visible consequences. For example, if the `main` function never returns (perhaps it calls `std::process::exit` to terminate the program early), then the corrupted return address probably won't matter.

You may only use unsafe features within an `unsafe` block or an `unsafe` function; we'll explain both in the sections that follow. This makes it harder to use unsafe features unknowingly: by forcing you to write an `unsafe` block or function, Rust makes sure you have acknowledged that your code may have additional rules to follow.

## Unsafe Blocks

An `unsafe` block looks just like an ordinary Rust block preceded by the `unsafe` keyword, with the difference that you can use unsafe features in the block:

```
unsafe {  
    String::from_utf8_unchecked(ascii)  
}
```

Without the `unsafe` keyword in front of the block, Rust would object to the use of `from_utf8_unchecked`, which is an unsafe function. With the `unsafe` block around it, you can use this code anywhere.

Like an ordinary Rust block, the value of an `unsafe` block is that of its final expression, or `()` if it doesn't have one. The call to `String::from_utf8_unchecked` shown earlier provides the value of the block.

An `unsafe` block unlocks four additional options for you:

- You can call `unsafe` functions. Each `unsafe` function must specify its own contract, depending on its purpose.
- You can dereference raw pointers. Safe code can pass raw pointers around, compare them, and create them by conversion from references (or even from integers), but only `unsafe` code can actually use them to access memory. We'll cover raw pointers in detail and explain how to use them safely in [“Raw Pointers” on page 538](#).
- You can access mutable `static` variables. As explained in [“Global Variables” on page 496](#), Rust can't be sure when threads are using mutable `static` variables, so their contract requires you to ensure all access is properly synchronized.
- You can access functions and variables declared through Rust's foreign function interface. These are considered `unsafe` even when immutable, since they are visible to code written in other languages that may not respect Rust's safety rules.

Restricting `unsafe` features to `unsafe` blocks doesn't really prevent you from doing whatever you want. It's perfectly possible to just stick an `unsafe` block into your code and move on. The benefit of the rule lies mainly in drawing human attention to code whose safety Rust can't guarantee:

- You won't accidentally use `unsafe` features, and then discover you were responsible for contracts you didn't even know existed.
- An `unsafe` block attracts more attention from reviewers. Some projects even have automation to ensure this, flagging code changes that affect `unsafe` blocks for special attention.
- When you're considering writing an `unsafe` block, you can take a moment to ask yourself whether your task really requires such measures. If it's for performance, do you have measurements to show that this is actually a bottleneck? Perhaps there is a good way to accomplish the same thing in safe Rust.

## Example: An Efficient ASCII String Type

Here's the definition of `Ascii`, a string type that ensures its contents are always valid ASCII. This type uses an unsafe feature to provide zero-cost conversion into `String`:

```
mod my_ascii {
    use std::ascii::AsciiExt; // for u8::is_ascii

    /// An ASCII-encoded string.
    #[derive(Debug, Eq, PartialEq)]
    pub struct Ascii(
        // This must hold only well-formed ASCII text:
        // bytes from `0` to `0x7f`.
        Vec<u8>
    );

    impl Ascii {
        /// Create an `Ascii` from the ASCII text in `bytes`. Return a
        /// `NotAsciiError` error if `bytes` contains any non-ASCII
        /// characters.
        pub fn from_bytes(bytes: Vec<u8>) -> Result<Ascii, NotAsciiError> {
            if bytes.iter().any(|&byte| !byte.is_ascii()) {
                return Err(NotAsciiError(bytes));
            }
            Ok(Ascii(bytes))
        }
    }

    // When conversion fails, we give back the vector we couldn't convert.
    // This should implement `std::error::Error`; omitted for brevity.
    #[derive(Debug, Eq, PartialEq)]
    pub struct NotAsciiError(pub Vec<u8>);

    // Safe, efficient conversion, implemented using unsafe code.
    impl From<Ascii> for String {
        fn from(ascii: Ascii) -> String {
            // If this module has no bugs, this is safe, because
            // well-formed ASCII text is also well-formed UTF-8.
            unsafe { String::from_utf8_unchecked(ascii.0) }
        }
    }
    ...
}
```

The key to this module is the definition of the `Ascii` type. The type itself is marked `pub`, to make it visible outside the `my_ascii` module. But the type's `Vec<u8>` element is *not* public, so only the `my_ascii` module can construct an `Ascii` value or refer to its element. This leaves the module's code in complete control over what may or may not appear there. As long as the public constructors and methods ensure that freshly created `Ascii` values are well-formed and remain so throughout their lives, then the rest of the program cannot violate that rule. And indeed, the public constructor

`Ascii::from_bytes` carefully checks the vector it's given before agreeing to construct an `Ascii` from it. For brevity's sake, we don't show any methods, but you can imagine a set of text-handling methods that ensure `Ascii` values always contain proper ASCII text, just as a `String`'s methods ensure that its contents remain well-formed UTF-8.

This arrangement lets us implement `From<Ascii>` for `String` very efficiently. The unsafe function `String::from_utf8_unchecked` takes a byte vector and builds a `String` from it without checking whether its contents are well-formed UTF-8 text; the function's contract holds its caller responsible for that. Fortunately, the rules enforced by the `Ascii` type are exactly what we need to satisfy `from_utf8_unchecked`'s contract. As we explained in “UTF-8” on page 392, any block of ASCII text is also well-formed UTF-8, so an `Ascii`'s underlying `Vec<u8>` is immediately ready to serve as a `String`'s buffer.

With these definitions in place, you can write:

```
use my_ascii::Ascii;

let bytes: Vec<u8> = b"ASCII and ye shall receive".to_vec();

// This call entails no allocation or text copies, just a scan.
let ascii: Ascii = Ascii::from_bytes(bytes)
    .unwrap(); // We know these chosen bytes are ok.

// This call is zero-cost: no allocation, copies, or scans.
let string = String::from(ascii);

assert_eq!(string, "ASCII and ye shall receive");
```

No unsafe blocks are required to use `Ascii`. We have implemented a safe interface using unsafe operations, and arranged to meet their contracts depending only on the module's own code, not on its users' behavior.

An `Ascii` is nothing more than a wrapper around a `Vec<u8>`, hidden inside a module that enforces extra rules about its contents. A type of this sort is called a *newtype*, a common pattern in Rust. Rust's own `String` type is defined in exactly the same way, except that its contents are restricted to be UTF-8, not ASCII. In fact, here's the definition of `String` from the standard library:

```
pub struct String {
    vec: Vec<u8>,
}
```

At the machine level, with Rust's types out of the picture, a newtype and its element have identical representations in memory, so constructing a newtype doesn't require any machine instructions at all. In `Ascii::from_bytes`, the expression `Ascii(bytes)` simply deems the `Vec<u8>`'s representation to now hold an `Ascii` value. Similarly,



`String::from_utf8_unchecked` probably requires no machine instructions when inlined: the `Vec<u8>` is now considered to be a `String`.

## Unsafe Functions

An unsafe function definition looks like an ordinary function definition preceded by the `unsafe` keyword. The body of an unsafe function is automatically considered an unsafe block.

You may call unsafe functions only within unsafe blocks. This means that marking a function `unsafe` warns its callers that the function has a contract they must satisfy to avoid undefined behavior.

For example, here's a new constructor for the `Ascii` type we introduced before that builds an `Ascii` from a byte vector without checking if its contents are valid ASCII:

```
// This must be placed inside the `my_ascii` module.
impl Ascii {
    /// Construct an `Ascii` value from `bytes`, without checking
    /// whether `bytes` actually contains well-formed ASCII.
    ///
    /// This constructor is infallible, and returns an `Ascii` directly,
    /// rather than a `Result<Ascii, NotAsciiError>` as the `from_bytes`
    /// constructor does.
    ///
    /// # Safety
    ///
    /// The caller must ensure that `bytes` contains only ASCII
    /// characters: bytes no greater than 0x7f. Otherwise, the effect is
    /// undefined.
    pub unsafe fn from_bytes_unchecked(bytes: Vec<u8>) -> Ascii {
        Ascii(bytes)
    }
}
```

Presumably, code calling `Ascii::from_bytes_unchecked` already knows somehow that the vector in hand contains only ASCII characters, so the check that `Ascii::from_bytes` insists on carrying out would be a waste of time, and the caller would have to write code to handle `Err` results that it knows will never occur. `Ascii::from_bytes_unchecked` lets such a caller sidestep the checks and the error handling.

But the comment above the definition of the `Ascii` type says, “Nothing in this module permits the introduction of non-ASCII bytes into an `Ascii` value.” Isn’t that exactly what this new `from_bytes_unchecked` constructor does?

Not quite: `from_bytes_unchecked` meets its obligations by passing them on to its caller via its contract. The presence of this contract is what makes it correct to mark

this function `unsafe`: despite the fact that the function itself carries out no unsafe operations, its callers must follow rules Rust cannot enforce automatically to avoid undefined behavior.

Can you really cause undefined behavior by breaking the contract of `Ascii::from_bytes_unchecked`? Yes. You can construct a `String` holding ill-formed UTF-8 as follows:

```
// Imagine that this vector is the result of some complicated process
// that we expected to produce ASCII. Something went wrong!
let bytes = vec![0xf7, 0xbf, 0xbf, 0xbf];

let ascii = unsafe {
    // This unsafe function's contract is violated
    // when `bytes` holds non-ASCII bytes.
    Ascii::from_bytes_unchecked(bytes)
};

let bogus: String = ascii.into();

// `bogus` now holds ill-formed UTF-8. Parsing its first character
// produces a `char` that is not a valid Unicode code point.
assert_eq!(bogus.chars().next().unwrap() as u32, 0x1fffff);
```

This illustrates two critical facts about bugs and unsafe code:

- *Bugs that occur before the unsafe block can break contracts.* Whether an unsafe block causes undefined behavior can depend not just on the code in the block itself, but also on the code that supplies the values it operates on. Everything that your unsafe code relies on to satisfy contracts is safety-critical. The conversion from `Ascii` to `String` based on `String::from_utf8_unchecked` is well-defined only if the rest of the module properly maintains `Ascii`'s invariants.
- *The consequences of breaking a contract may appear after you leave the unsafe block.* The undefined behavior courted by failing to comply with an unsafe feature's contract often does not occur within the unsafe block itself. Constructing a bogus `String` as shown before may not cause problems until much later in the program's execution.

Essentially, Rust's type checker, borrow checker, and other static checks are inspecting your program and trying to construct a proof that it cannot exhibit undefined behavior. When Rust compiles your program successfully, that means it succeeded in proving your code sound. An unsafe block is a gap in this proof: "This code," you are saying to Rust, "is fine, trust me." Whether your claim is true could depend on any part of the program that influences what happens in the unsafe block, and the consequences of being wrong could appear anywhere influenced by the unsafe block.

Writing the `unsafe` keyword amounts to a reminder that you are not getting the full benefit of the language's safety checks.

Given the choice, you should naturally prefer to create safe interfaces, without contracts. These are much easier to work with, since users can count on Rust's safety checks to ensure their code is free of undefined behavior. Even if your implementation uses unsafe features, it's best to use Rust's types, lifetimes, and module system to meet their contracts while using only what you can guarantee yourself, rather than passing responsibilities on to your callers.

Unfortunately, it's not unusual to come across unsafe functions in the wild whose documentation does not bother to explain their contracts. You are expected to infer the rules yourself, based on your experience and knowledge of how the code behaves. If you've ever uneasily wondered whether what you're doing with a C or C++ API is OK, then you know what that's like.

## Unsafe Block or Unsafe Function?

You may find yourself wondering whether to use an `unsafe` block or just mark the whole function `unsafe`. The approach we recommend is to first make a decision about the function:

- If it's possible to misuse the function in a way that compiles fine but still causes undefined behavior, you must mark it as `unsafe`. The rules for using the function correctly are its contract; the existence of a contract is what makes the function `unsafe`.
- Otherwise, the function is safe: no well-typed call to it can cause undefined behavior. It should not be marked `unsafe`.

Whether the function uses unsafe features in its body is irrelevant; what matters is the presence of a contract. Before, we showed an `unsafe` function that uses no unsafe features, and a safe function that does use unsafe features.

Don't mark a safe function `unsafe` just because you use unsafe features in its body. This makes the function harder to use, and confuses readers who will (correctly) expect to find a contract explained somewhere. Instead, use an `unsafe` block, even if it's the function's entire body.

## Undefined Behavior

In the introduction, we said that the term *undefined behavior* means “behavior that Rust firmly assumes your code could never exhibit.” This is a strange turn of phrase, especially since we know from our experience with other languages that these behav-

iors *do* occur by accident with some frequency. Why is this concept helpful in setting out the obligations of unsafe code?

A compiler is a translator from one programming language to another. The Rust compiler takes a Rust program and translates it into an equivalent machine language program. But what does it mean to say that two programs in such completely different languages are equivalent?

Fortunately, this question is easier for programmers than it is for linguists. We usually say that two programs are equivalent if they will always have the same visible behavior when executed: they make the same system calls, interact with foreign libraries in equivalent ways, and so on. It's a bit like a Turing test for programs: if you can't tell whether you're interacting with the original or the translation, then they're equivalent.

Now consider the following code:

```
let i = 10;
very_trustworthy(&i);
println!("{}", i * 100);
```

Even knowing nothing about the definition of `very_trustworthy`, we can see that it receives only a shared reference to `i`, so the call cannot change `i`'s value. Since the value passed to `println!` will always be `1000`, Rust can translate this code into machine language as if we had written:

```
very_trustworthy(&10);
println!("{}", 1000);
```

This transformed version has the same visible behavior as the original, and it's probably a bit faster. But it makes sense to consider the performance of this version only if we agree it has the same meaning as the original. What if `very_trustworthy` were defined as follows?

```
fn very_trustworthy(shared: &i32) {
    unsafe {
        // Turn the shared reference into a mutable pointer.
        // This is undefined behavior.
        let mutable = shared as *const i32 as *mut i32;
        *mutable = 20;
    }
}
```

This code breaks the rules for shared references: it changes the value of `i` to `20`, even though it should be frozen because `i` is borrowed for sharing. As a result, the transformation we made to the caller now has a very visible effect: if Rust transforms the code, the program prints `1000`; if it leaves the code alone and uses the new value of `i`, it prints `2000`. Breaking the rules for shared references in `very_trustworthy` means that shared references won't behave as expected in its callers.

This sort of problem arises with almost every kind of transformation Rust might attempt. Even inlining a function into its call site assumes, among other things, that when the callee finishes, control flow returns to the call site. But we opened the chapter with an example of ill-behaved code that violates even that assumption.

It's basically impossible for Rust (or any other language) to assess whether a transformation to a program preserves its meaning unless it can trust the fundamental features of the language to behave as designed. And whether they do or not can depend not just on the code at hand, but on other, potentially distant, parts of the program. In order to do anything at all with your code, Rust must assume that the rest of your program is well-behaved.

Here, then, are Rust's rules for well-behaved programs:

- The program must not read uninitialized memory.
- The program must not create invalid primitive values:
  - References or boxes that are `null`
  - `bool` values that are not either a `0` or `1`
  - `enum` values with invalid discriminant values
  - `char` values that are not valid, nonsurrogate Unicode code points
  - `str` values that are not well-formed UTF-8
- The rules for references explained in [Chapter 5](#) must be followed. No reference may outlive its referent; shared access is read-only access; and mutable access is exclusive access.
- The program must not dereference null, incorrectly aligned, or dangling pointers.
- The program must not use a pointer to access memory outside the allocation with which the pointer is associated. We will explain this rule in detail in [“Dereferencing Raw Pointers Safely” on page 540](#).
- The program must be free of data races. A data race occurs when two threads access the same memory location without synchronization, and at least one of the accesses is a write.
- The program must not unwind across a call made from another language, via the foreign function interface, as explained in [“Unwinding” on page 146](#).
- The program must comply with the contracts of standard library functions.

These rules are all that Rust assumes in the process of optimizing your program and translating it into machine language. Undefined behavior is, simply, any violation of these rules. This is why we say that Rust assumes your program will not exhibit undefined behavior: this assumption is necessary if we hope to conclude that the compiled program is a faithful translation of the source code.

Rust code that does not use unsafe features is guaranteed to follow all of the preceding rules, once it compiles. Only when you use unsafe features do these rules become your responsibility. In C and C++, the fact that your program compiles without errors or warnings means much less; as we mentioned in the introduction to this book, even the best C and C++ programs written by well-respected projects that hold their code to high standards exhibit undefined behavior in practice.

## Unsafe Traits

An *unsafe trait* is a trait that has a contract Rust cannot check or enforce that implementers must satisfy to avoid undefined behavior. To implement an unsafe trait, you must mark the implementation as unsafe. It is up to you to understand the trait's contract, and make sure your type satisfies it.

A function that bounds its type variables with an unsafe trait is typically one that uses unsafe features itself, and satisfies their contracts only by depending on the unsafe trait's contract. An incorrect implementation of the trait could cause such a function to exhibit undefined behavior.

The classic examples of unsafe traits are `std::marker::Send` and `std::marker::Sync`. These traits don't define any methods, so they're trivial to implement for any type you like. But they do have contracts: `Send` requires implementers to be safe to move to another thread, and `Sync` requires them to be safe to share among threads via shared references. Implementing `Send` for an inappropriate type, for example, would make `std::sync::Mutex` no longer safe from data races.

As a simple example, the Rust library includes an unsafe trait, `core::nonzero::Zeroable`, for types that can be safely initialized by setting all their bytes to zero. Clearly, zeroing a `usize` is fine, but zeroing a `&T` gives you a null reference, which will cause a crash if dereferenced. For types that are zeroable, some optimizations are possible: you can initialize an array of them quickly with `std::mem::write_bytes` (Rust's equivalent of `memset`), or use operating system calls that allocate zeroed pages. (As of Rust 1.17, `Zeroable` is experimental, so it may be changed or removed in future versions of Rust, but it's a good, simple, real-world example.)

`Zeroable` is a typical marker trait, lacking methods or associated types:

```
pub unsafe trait Zeroable {}
```

The implementations for appropriate types are similarly straightforward:

```
unsafe impl Zeroable for u8 {}
unsafe impl Zeroable for i32 {}
unsafe impl Zeroable for usize {}
// and so on for all the integer types
```

With these definitions, we can write a function that quickly allocates a vector of a given length containing a Zeroable type:

```
#![feature(nonzero)] // permits `Zeroable`

extern crate core;
use core::nonzero::Zeroable;

fn zeroed_vector<T>(len: usize) -> Vec<T>
where T: Zeroable
{
    let mut vec = Vec::with_capacity(len);
    unsafe {
        std::ptr::write_bytes(vec.as_mut_ptr(), 0, len);
        vec.set_len(len);
    }
    vec
}
```

This function starts by creating an empty `Vec` with the required capacity, and then calls `write_bytes` to fill the unoccupied buffer with zeros. (The `write_byte` function treats `len` as a number of `T` elements, not a number of bytes, so this call does fill the entire buffer.) A vector's `set_len` method changes its length without doing anything to the buffer; this is unsafe, because you must ensure that the newly enclosed buffer space actually contains properly initialized values of type `T`. But this is exactly what the `T: Zeroable` bound establishes: a block of zero bytes represent a valid `T` value. Our use of `set_len` is safe.

Here, we put it to use:

```
let v: Vec<usize> = zeroed_vector(100_000);
assert!(v.iter().all(|&u| u == 0));
```

Clearly, `Zeroable` must be an unsafe trait, since an implementation that doesn't respect its contract can lead to undefined behavior:

```
struct HoldsRef<'a>(&'a mut i32);

unsafe impl<'a> Zeroable for HoldsRef<'a> { }

let mut v: Vec<HoldsRef> = zeroed_vector(1);
*v[0].0 = 1; // crashes: dereferences null pointer
```

Rust compiles this without complaint: it has no idea what `Zeroable` is meant to signify, so it can't tell when it's being implemented for an inappropriate type. As with any other unsafe feature, it's up to you to understand and adhere to an unsafe trait's contract.

Note that unsafe code must not depend on ordinary, safe traits being implemented correctly. For example, suppose there were an implementation of the

`std::hash::Hasher` trait that simply returned a random hash value, with no relation to the values being hashed. The trait requires that hashing the same bits twice must produce the same hash value, but this implementation doesn't meet that requirement; it's simply incorrect. But because `Hasher` is not an unsafe trait, unsafe code must not exhibit undefined behavior when it uses this hasher. The `std::collections::HashMap` type is carefully written to respect the contracts of the unsafe features it uses regardless of how the hasher behaves. Certainly, the table won't function correctly: lookups will fail, and entries will appear and disappear at random. But the table will not exhibit undefined behavior.

## Raw Pointers

A *raw pointer* in Rust is an unconstrained pointer. You can use raw pointers to form all sorts of structures that Rust's checked pointer types cannot, like doubly linked lists or arbitrary graphs of objects. But because raw pointers are so flexible, Rust cannot tell whether you are using them safely or not, so you can dereference them only in an `unsafe` block.

Raw pointers are essentially equivalent to C or C++ pointers, so they're also useful for interacting with code written in those languages.

There are two kinds of raw pointers:

- A `*mut T` is a raw pointer to a `T` that permits modifying its referent.
- A `*const T` is a raw pointer to a `T` that only permits reading its referent.

(There is no plain `*T` type; you must always specify either `const` or `mut`.)

You can create a raw pointer by conversion from a reference, and dereference it with the `*` operator:

```
let mut x = 10;
let ptr_x = &mut x as *mut i32;

let y = Box::new(20);
let ptr_y = &*y as *const i32;

unsafe {
    *ptr_x += *ptr_y;
}
assert_eq!(x, 30);
```

Unlike boxes and references, raw pointers can be null, like `NULL` in C or `nullptr` in C++:

```
fn option_to_raw<T>(opt: Option<&T>) -> *const T {
    match opt {
        None => std::ptr::null(),
```



```

        Some(r) => r as *const T
    }
}

assert!(!option_to_raw(Some(&("pea", "pod"))).is_null());
assert_eq!(option_to_raw::<i32>(None), std::ptr::null());

```

This example has no unsafe blocks: creating raw pointers, passing them around, and comparing them are all safe. Only dereferencing a raw pointer is unsafe.

A raw pointer to an unsized type is a fat pointer, just as the corresponding reference or Box type would be. A `*const [u8]` pointer includes a length along with the address, and a trait object like `*mut std::io::Write` pointer carries a vtable.

Although Rust implicitly dereferences safe pointer types in various situations, raw pointer dereferences must be explicit:

- The `.` operator will not implicitly dereference a raw pointer; you must write `(*raw).field` or `(*raw).method(...)`.
- Raw pointers do not implement `Deref`, so `deref` coercions do not apply to them.
- Operators like `==` and `<` compare raw pointers as addresses: two raw pointers are equal if they point to the same location in memory. Similarly, hashing a raw pointer hashes the address it points to, not the value of its referent.
- Formatting traits like `std::fmt::Display` follow references automatically, but don't handle raw pointers at all. The exceptions are `std::fmt::Debug` and `std::fmt::Pointer`, which show raw pointers as hexadecimal addresses, without dereferencing them.

Unlike the `+` operator in C and C++, Rust's `+` does not handle raw pointers, but you can perform pointer arithmetic via their `offset` and `wrapping_offset` methods. There is no standard operation for finding the distance between two pointers, as the `-` operator does in C and C++, but you can write one yourself:

```

fn distance<T>(left: *const T, right: *const T) -> isize {
    (left as isize - right as isize) / std::mem::size_of::<T>() as isize
}

let trucks = vec!["garbage truck", "dump truck", "moonstruck"];
let first = &trucks[0];
let last = &trucks[2];
assert_eq!(distance(last, first), 2);
assert_eq!(distance(first, last), -2);

```

Even though `distance`'s parameters are raw pointers, we can pass it references: Rust implicitly coerces references to raw pointers (but not the other way around, of course).

The `as` operator permits almost every plausible conversion from references to raw pointers or between two raw pointer types. However, you may need to break up a complex conversion into a series of simpler steps. For example:

```
&vec![42_u8] as *const String // error: invalid conversion
&vec![42_u8] as *const Vec<u8> as *const String; // permitted
```

Note that `as` will not convert raw pointers to references. Such conversions would be unsafe, and `as` should remain a safe operation. Instead, you must dereference the raw pointer (in an `unsafe` block), and then borrow the resulting value.

Be very careful when you do this: a reference produced this way has an unconstrained lifetime: there's no limit on how long it can live, since the raw pointer gives Rust nothing to base such a decision on. In [“A Safe Interface to libgit2” on page 572](#) later in this chapter, we show several examples of how to properly constrain lifetimes.

Many types have `as_ptr` and `as_mut_ptr` methods that return a raw pointer to their contents. For example, array slices and strings return pointers to their first elements, and some iterators return a pointer to the next element they will produce. Owing pointer types like `Box`, `Rc`, and `Arc` have `into_raw` and `from_raw` functions that convert to and from raw pointers. Some of these methods' contracts impose surprising requirements, so check their documentation before using them.

You can also construct raw pointers by conversion from integers, although the only integers you can trust for this are generally those you got from a pointer in the first place. [“Example: RefWithFlag” on page 541](#) uses raw pointers this way.

Unlike references, raw pointers are neither `Send` nor `Sync`. As a result, any type that includes raw pointers does not implement these traits by default. There is nothing inherently unsafe about sending or sharing raw pointers between threads; after all, wherever they go, you still need an `unsafe` block to dereference them. But given the roles raw pointers typically play, the language designers considered this behavior to be the more helpful default. We already discussed how to implement `Send` and `Sync` yourself in [“Unsafe Traits” on page 536](#).

## Dereferencing Raw Pointers Safely

Here are some common-sense guidelines for using raw pointers safely:

- Dereferencing null pointers or dangling pointers is undefined behavior, as is referring to uninitialized memory, or values that have gone out of scope.
- Dereferencing pointers that are not properly aligned for their referent type is undefined behavior.
- You may borrow values out of a dereferenced raw pointer only if doing so obeys the rules for reference safety explained in [Chapter 5](#): No reference may outlive its

referent; shared access is read-only access; and mutable access is exclusive access. (This rule is easy to violate by accident, since raw pointers are often used to create data structures with nonstandard sharing or ownership.)

- You may use a raw pointer's referent only if it is a well-formed value of its type. For example, you must ensure that dereferencing a `*const char` yields a proper, nonsurrogate Unicode code point.
- You may use the `offset` and `wrapping_offset` methods on raw pointers only to point to bytes within the variable or heap-allocated block of memory that the original pointer referred to, or to the first byte beyond such a region.

If you do pointer arithmetic by converting the pointer to an integer, doing arithmetic on the integer, and then converting it back to a pointer, the result must be a pointer that the rules for the `offset` method would have allowed you to produce.

- If you assign to a raw pointer's referent, you must not violate the invariants of any type of which the referent is a part. For example, if you have a `*mut u8` pointing to a byte of a `String`, you may only store values in that `u8` that leave the `String` holding well-formed UTF-8.

The borrowing rule aside, these are essentially the same rules you must follow when using pointers in C or C++.

The reason for not violating types' invariants should be clear. Many of Rust's standard types use unsafe code in their implementation, but still provide safe interfaces on the assumption that Rust's safety checks, module system, and visibility rules will be respected. Using raw pointers to circumvent these protective measures can lead to undefined behavior.

The complete, exact contract for raw pointers is not easily stated, and may change as the language evolves. But the principles outlined here should keep you in safe territory.

## Example: RefWithFlag

Here's an example of how to take a classic<sup>1</sup> bit-level hack made possible by raw pointers, and wrap it up as a completely safe Rust type. This module defines a type, `RefWithFlag<'a, T>`, that holds both a `&'a T` and a `bool`, like the tuple `(&'a T, bool)`, and yet still manages to occupy only one machine word instead of two. This sort of technique is used regularly in garbage collectors and virtual machines, where certain types—say, the type representing an object—are so numerous that adding even a single word to each value would drastically increase memory use:

---

<sup>1</sup> Well, it's a classic where we come from.

```

mod ref_with_flag {
    use std::marker::PhantomData;
    use std::mem::align_of;

    /// A `&T` and a `bool`, wrapped up in a single word.
    /// The type `T` must require at least two-byte alignment.
    ///
    /// If you're the kind of programmer who's never met a pointer whose
    /// 2o-bit you didn't want to steal, well, now you can do it safely!
    /// ("But it's not nearly as exciting this way...")
    pub struct RefWithFlag<'a, T: 'a> {
        ptr_and_bit: usize,
        behaves_like: PhantomData<&'a T> // occupies no space
    }

    impl<'a, T: 'a> RefWithFlag<'a, T> {
        pub fn new(ptr: &'a T, flag: bool) -> RefWithFlag<T> {
            assert!(align_of::<T>() % 2 == 0);
            RefWithFlag {
                ptr_and_bit: ptr as *const T as usize | flag as usize,
                behaves_like: PhantomData
            }
        }

        pub fn get_ref(&self) -> &'a T {
            unsafe {
                let ptr = (self.ptr_and_bit & !1) as *const T;
                &*ptr
            }
        }

        pub fn get_flag(&self) -> bool {
            self.ptr_and_bit & 1 != 0
        }
    }
}

```

This code takes advantage of the fact that many types must be placed at even addresses in memory: since an even address's least significant bit is always zero, we can store something else there, and then reliably reconstruct the original address just by masking off the bottom bit. Not all types qualify; for example, the types `u8` and `(bool, [i8; 2])` can be placed at any address. But we can check the type's alignment on construction and refuse types that won't work.

You can use `RefWithFlag` like this:

```

use ref_with_flag::RefWithFlag;

let vec = vec![10, 20, 30];
let flagged = RefWithFlag::new(&vec, true);
assert_eq!(flagged.get_ref()[1], 20);
assert_eq!(flagged.get_flag(), true);

```

The constructor `RefWithFlag::new` takes a reference and a `bool` value, asserts that the reference's type is suitable, and then converts the reference to a raw pointer, and then a `usize`. The `usize` type is defined to be large enough to hold a pointer on whatever processor we're compiling for, so converting a raw pointer to a `usize` and back is well-defined. Once we have a `usize`, we know it must be even, so we can use the `|` bitwise-or operator to combine it with the `bool`, which we've converted to an integer 0 or 1.

The `get_flag` method extracts the `bool` component of a `RefWithFlag`. It's simple: just mask off the bottom bit and check if it's nonzero.

The `get_ref` method extracts the reference from a `RefWithFlag`. First, it masks off the `usize`'s bottom bit and converts it to a raw pointer. The `as` operator will not convert raw pointers to references, but we can dereference the raw pointer (in an `unsafe` block, naturally) and borrow that. Borrowing a raw pointer's referent gives you a reference with an unbounded lifetime: Rust will accord the reference whatever lifetime would make the code around it check, if there is one. Usually, though, there is some specific lifetime which is more accurate, and would thus catch more mistakes. In this case, since `get_ref`'s return type is `&'a T`, Rust infers that the reference's lifetime must be the `RefWithFlag`'s argument, which is just what we want: that's the lifetime of the reference we started with.

In memory, a `RefWithFlag` looks just like a `usize`: since `PhantomData` is a zero-sized type, the `behaves_like` field takes up no space in the structure. But the `PhantomData` is necessary for Rust to know how to treat lifetimes in code that uses `RefWithFlag`. Imagine what the type would look like without the `behaves_like` field:

```
// This won't compile.
pub struct RefWithFlag<'a, T: 'a> {
    ptr_and_bit: usize
}
```

In [Chapter 5](#), we pointed out that any structure containing references must not outlive the values they borrow, lest the references become dangling pointers. The structure must abide by the restrictions that apply to its fields. This certainly applies to `RefWithFlag`: in the example code we just looked at, `flagged` must not outlive `vec`, since `flagged.get_ref()` returns a reference to it. But our reduced `RefWithFlag` type contains no references at all, and never uses its lifetime parameter `'a`. It's just a `usize`. How should Rust know that any restrictions apply to `pub`'s lifetime? Including a `PhantomData<&'a T>` field tells Rust to treat `RefWithFlag<'a, T>` as if it contained a `&'a T`, without actually affecting the struct's representation.

Although Rust doesn't really know what's going on (that's what makes `RefWithFlag` `unsafe`), it will do its best to help you out with this. If you omit the `_marker` field, Rust

will complain that the parameters 'a and T are unused, and suggest using a PhantomData.

RefWithFlag uses the same tactics as the Ascii type we presented earlier to avoid undefined behavior in its unsafe block. The type itself is pub, but its fields are not, meaning that only code within the pointer\_and\_bool module can create or look inside a RefWithFlag value. You don't have to inspect much code to have confidence that the ptr\_and\_bit field is well constructed.

## Nullable Pointers

A null raw pointer in Rust is a zero address, just as in C and C++. For any type T, the std::ptr::null<T> function returns a \*const T null pointer, and std::ptr::null\_mut<T> returns a \*mut T null pointer.

There are a few ways to check whether a raw pointer is null. The simplest is the is\_null method, but the as\_ref method may be more convenient: it takes a \*const T pointer and returns an Option<&'a T>, turning a null pointer into a None. Similarly, the as\_mut method converts \*mut T pointers into Option<&'a mut T> values.

## Type Sizes and Alignments

A value of any Sized type occupies a constant number of bytes in memory, and must be placed at an address that is a multiple of some alignment value, determined by the machine architecture. For example, an (i32, i32) tuple occupies eight bytes, and most processors prefer it to be placed at an address that is a multiple of four.

The call std::mem::size\_of::<T>() returns the size of a value of type T, in bytes, and std::mem::align\_of::<T>() returns its required alignment. For example:

```
assert_eq!(std::mem::size_of::<i64>(), 8);
assert_eq!(std::mem::align_of::<(i32, i32)>(), 4);
```

Any type's alignment is always a power of two.

A type's size is always rounded up to a multiple of its alignment, even if it technically could fit in less space. For example, even though a tuple like (f32, u8) requires only five bytes, size\_of::<(f32, u8)>() is 8, because align\_of::<(f32, u8)>() is 4. This ensures that if you have an array, the size of the element type always reflects the spacing between one element and the next.

For unsized types, the size and alignment depend on the value at hand. Given a reference to an unsized value, the std::mem::size\_of\_val and std::mem::align\_of\_val functions return the value's size and alignment. These functions can operate on references to both Sized and unsized types.

```

// Fat pointers to slices carry their referent's length.
let slice: &[i32] = &[1, 3, 9, 27, 81];
assert_eq!(std::mem::size_of_val(slice), 20);

let text: &str = "alligator";
assert_eq!(std::mem::size_of_val(text), 9);

use std::fmt::Display;
let unremarkable: &Display = &193_u8;
let remarkable: &Display = &0.0072973525664;

// These return the size/alignment of the value the
// trait object points to, not those of the trait object
// itself. This information comes from the vtable the
// trait object refers to.
assert_eq!(std::mem::size_of_val(unremarkable), 1);
assert_eq!(std::mem::align_of_val(remarkable), 8);

```

## Pointer Arithmetic

Rust lays out the elements of an array, slice, or vector as a single contiguous block of memory, as shown in [Figure 21-1](#). Elements are regularly spaced, so that if each element occupies `size` bytes, then the `i`'th element starts with the `i * size`'th byte.

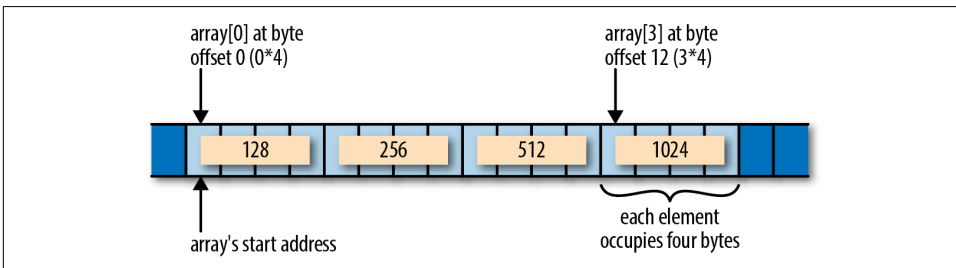

Figure 21-1. An array in memory

One nice consequence of this is that if you have two raw pointers to elements of an array, comparing the pointers gives the same results as comparing the elements' indices: if `i < j`, then a raw pointer to the `i`'th element is less than a raw pointer to the `j`'th element. This makes raw pointers useful as bounds on array traversals. In fact, the standard library's simple iterator over a slice is defined like this:

```

struct Iter<'a, T: 'a> {
    ptr: *const T,
    end: *const T,
    ...
}

```

The `ptr` field points to the next element iteration should produce, and the `end` field serves as the limit: when `ptr == end`, the iteration is complete.

Another nice consequence of array layout: if `element_ptr` is a `*const T` or `*mut T` raw pointer to the `i`'th element of some array, then `element_ptr.offset(o)` is a raw pointer to the `(i + o)`'th element. Its definition is equivalent to this:

```
fn offset(self: *const T, count: isize) -> *const T
    where T: Sized
{
    let bytes_per_element = std::mem::size_of::<T>() as isize;
    let byte_offset = count * bytes_per_element;
    (self as isize).checked_add(byte_offset).unwrap() as *const T
}
```

The `std::mem::size_of::<T>` function returns the size of the type `T` in bytes. Since `isize` is, by definition, large enough to hold an address, you can convert the base pointer to an `isize`, do arithmetic on that value, and then convert the result back to a pointer.

It's fine to produce a pointer to the first byte after the end of an array. You cannot dereference such a pointer, but it can be useful to represent the limit of a loop, or for bounds checks.

However, it is undefined behavior to use `offset` to produce a pointer beyond that point, or before the start of the array, even if you never dereference it. For the sake of optimization, Rust would like to assume that `ptr.offset(i) > ptr` when `i` is positive, and that `ptr.offset(i) < ptr` when `i` is negative. This assumption seems safe, but it may not hold if the arithmetic in `offset` overflows an `isize` value. If `i` is constrained to stay within the same array as `ptr`, no overflow can occur: after all, the array itself does not overflow the bounds of the address space. (To make pointers to the first byte after the end safe, Rust never places values at the upper end of the address space.)

If you do need to offset pointers beyond the limits of the array they are associated with, you can use the `wrapping_offset` method. This is equivalent to `offset`, but Rust makes no assumptions about the relative ordering of `ptr.wrapping_offset(i)` and `ptr` itself. Of course, you still can't dereference such pointers unless they fall within the array.

## Moving into and out of Memory

If you are implementing a type that manages its own memory, you will need to track which parts of your memory hold live values and which are uninitialized, just as Rust does with local variables. Consider this code:

```
let pot = "pasta".to_string();
let plate;

plate = pot;
```



After this code has run, the situation looks like [Figure 21-2](#).

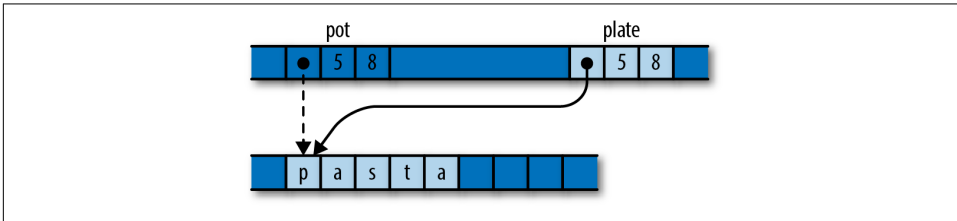

*Figure 21-2. Moving a string from one local variable to another*

After the assignment, `pot` is uninitialized, and `plate` is the owner of the string.

At the machine level, it's not specified what a move does to the source, but in practice it usually does nothing at all. The assignment probably leaves `pot` still holding a pointer, capacity, and length for the string. Naturally, it would be disastrous to treat this as a live value, and Rust ensures that you don't.

The same considerations apply to data structures that manage their own memory. Suppose you run this code:

```
let mut noodles = vec!["udon".to_string()];
let soba = "soba".to_string();
let last;
```

In memory, the state looks like [Figure 21-3](#).

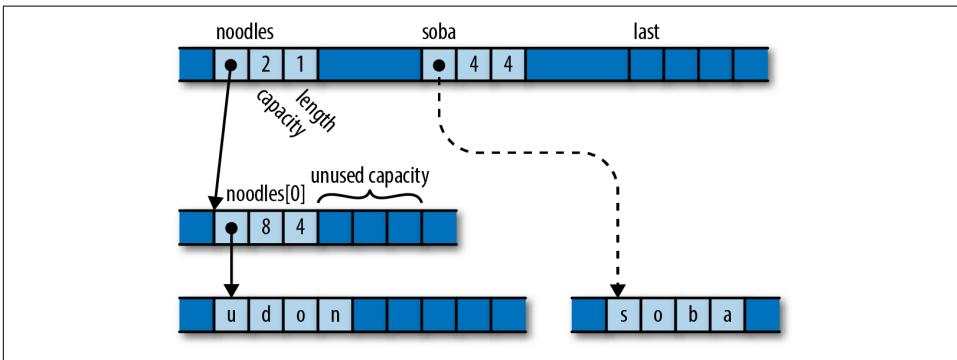

*Figure 21-3. A vector with uninitialized, spare capacity*

The vector has the spare capacity to hold one more element, but its contents are junk, probably whatever that memory held previously. Suppose you then run this code:

```
noodles.push(soba);
```

Pushing the string onto the vector transforms that uninitialized memory into a new element, as illustrated in [Figure 21-4](#).

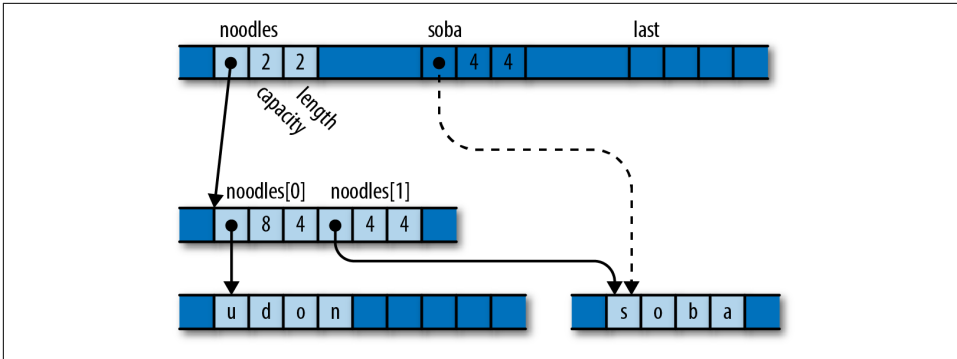

Figure 21-4. After pushing `soba`'s value onto the vector

The vector has initialized its empty space to own the string, and incremented its length to mark this as a new, live element. The vector is now the owner of the string; you can refer to its second element, and dropping the vector would free both strings. And `soba` is now uninitialized.

Finally, consider what happens when we pop a value from the vector:

```
last = noodles.pop().unwrap();
```

In memory, things now look like [Figure 21-5](#).

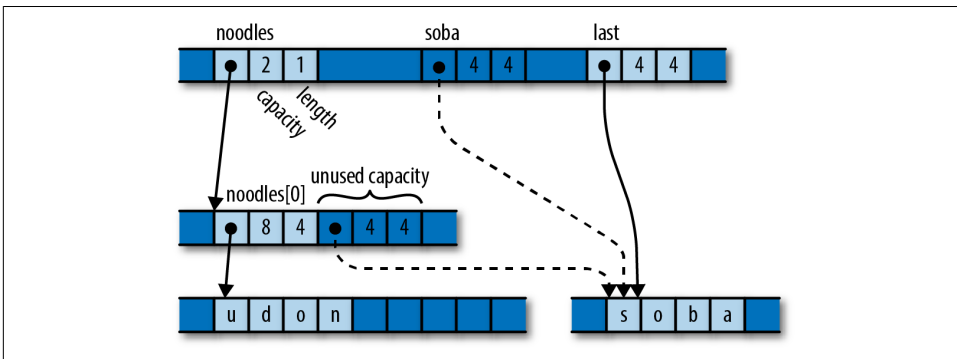

Figure 21-5. After popping an element from the vector into `last`

The variable `last` has taken ownership of the string. The vector has decremented its length to indicate that the space that used to hold the string is now uninitialized.

Just as with `pot` and `pasta` earlier, all three of `soba`, `last`, and the vector's free space probably hold identical bit patterns. But only `last` is considered to own the value. Treating either of the other two locations as live would be a mistake.

The true definition of an initialized value is one that is *treated as live*. Writing to a value's bytes is usually a necessary part of initialization, but only because doing so prepares the value to be treated as live.

Rust tracks local variables at compile time. Types like `Vec`, `HashMap`, `Box`, and so on track their buffers dynamically. If you implement a type that manages its own memory, you will need to do the same.

Rust provides two essential operations for implementing such types:

- **`std::ptr::read(src)`** moves a value out of the location `src` points to, transferring ownership to the caller. After calling `read`, you must treat `*src` as uninitialized memory. The `src` argument should be a `*const T` raw pointer, where `T` is a sized type.

This is the operation behind `Vec::pop`. Popping a value calls `read` to move the value out of the buffer, and then decrements the `length` to mark that space as uninitialized capacity.

- **`std::ptr::write(dest, value)`** moves `value` into the location `dest` points to, which must be uninitialized memory before the call. The referent now owns the value. Here, `dest` must be a `*mut T` raw pointer and `value` a `T` value, where `T` is a sized type.

This is the operation behind `Vec::push`. Pushing a value calls `write` to move the value into the next available space, and then increments the `length` to mark that space as a valid element.

Both are free functions, not methods on the raw pointer types.

Note that you cannot do these things with any of Rust's safe pointer types. They all require their referents to be initialized at all times, so transforming uninitialized memory into a value, or vice versa, is outside their reach. Raw pointers fit the bill.

The standard library also provides functions for moving arrays of values from one block of memory to another:

- **`std::ptr::copy(src, dst, count)`** moves the array of `count` values in memory starting at `src` to the memory at `dst`, just as if you had written a loop of `read` and `write` calls to move them one at a time. The destination memory must be uninitialized before the call, and afterward the source memory is left uninitialized. The `src` and `dest` arguments must be `*const T` and `*mut T` raw pointers, and `count` must be a `usize`.
- **`std::ptr::copy_nonoverlapping(src, dst, count)`** is like the corresponding call to `copy`, except that its contract further requires that the source and destina-

tion blocks of memory must not overlap. This may be slightly faster than calling `copy`.

There are two other families of `read` and `write` functions, also in the `std::ptr` module:

- The `read_unaligned` and `write_unaligned` functions are like `read` and `write`, except that the pointer need not be aligned as normally required for the referent type. These functions may be slower than the plain `read` and `write` functions.
- The `read_volatile` and `write_volatile` functions are the equivalent of volatile reads and writes in C or C++.

## Example: GapBuffer

Here's an example that puts the raw pointer functions just described to use.

Suppose you're writing a text editor, and you're looking for a type to represent the text. You could choose `String`, and use the `insert` and `remove` methods to insert and delete characters as the user types. But if they're editing text at the beginning of a large file, those methods can be expensive: inserting a new character involves shifting the entire rest of the string to the right in memory, and deletion shifts it all back to the left. You'd like such common operations to be cheaper.

The Emacs text editor uses a simple data structure called a *gap buffer* which can insert and delete characters in constant time. Whereas a `String` keeps all its spare capacity at the end of the text, which makes push and pop cheap, a gap buffer keeps its spare capacity in the midst of the text, at the point where editing is taking place. This spare capacity is called the *gap*. Inserting or deleting elements at the gap is cheap: you simply shrink or enlarge the gap as needed. You can move the gap to any location you like by shifting text from one side of the gap to the other. When the gap is empty, you migrate to a larger buffer.

While insertion and deletion in a gap buffer are fast, changing the position at which they take place entails moving the gap to the new position. Shifting the elements requires time proportional to the distance being moved. Fortunately, typical editing activity involves making a bunch of changes in one neighborhood of the buffer before going off and fiddling with text someplace else.

In this section we'll implement a gap buffer in Rust. To avoid being distracted by UTF-8, we'll make our buffer store `char` values directly, but the principles of operation would be the same if we stored the text in some other form.

First, we'll show a gap buffer in action. This code creates a `GapBuffer`, inserts some text in it, and then moves the insertion point to sit just before the last word:

```

use gap::GapBuffer;

let mut buf = GapBuffer::new();
buf.insert_iter("Lord of the Rings".chars());
buf.set_position(12);

```

After running this code, the buffer looks as shown in [Figure 21-6](#).

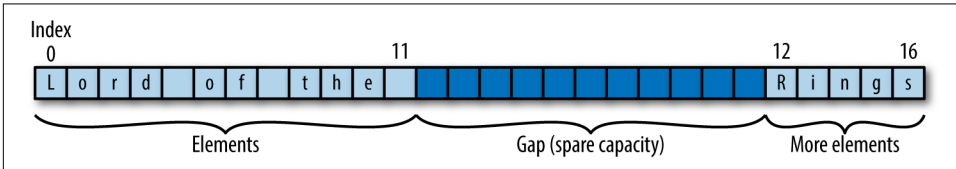

Figure 21-6. A gap buffer containing some text

Insertion is a matter of filling in the gap with new text. This code adds a word and ruins the film:

```

buf.insert_iter("Onion ".chars());

```

This results in the state shown in [Figure 21-7](#).

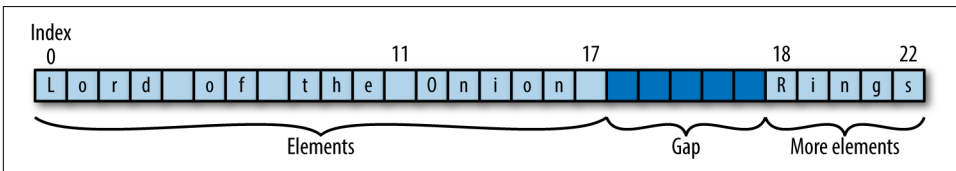

Figure 21-7. A gap buffer containing some more text

Here's our GapBuffer type:

```

mod gap {
    use std;
    use std::ops::Range;

    pub struct GapBuffer<T> {
        // Storage for elements. This has the capacity we need, but its length
        // always remains zero. GapBuffer puts its elements and the gap in this
        // `Vec`'s "unused" capacity.
        storage: Vec<T>,

        // Range of uninitialized elements in the middle of `storage`.
        // Elements before and after this range are always initialized.
        gap: Range<usize>
    }

    ...
}

```

GapBuffer uses its `storage` field in a strange way.<sup>2</sup> It never actually stores any elements in the vector—or not quite. It simply calls `Vec::with_capacity(n)` to get a block of memory large enough to hold `n` values, obtains raw pointers to that memory via the vector's `as_ptr` and `as_mut_ptr` methods, and then uses the buffer directly for its own purposes. The vector's length always remains zero. When the `Vec` gets dropped, the `Vec` doesn't try to free its elements, because it doesn't know it has any, but it does free the block of memory. This is what `GapBuffer` wants; it has its own `Drop` implementation that knows where the live elements are and drops them correctly.

`GapBuffer`'s simplest methods are what you'd expect:

```
impl<T> GapBuffer<T> {
    pub fn new() -> GapBuffer<T> {
        GapBuffer { storage: Vec::new(), gap: 0..0 }
    }

    /// Return the number of elements this GapBuffer could hold without
    /// reallocation.
    pub fn capacity(&self) -> usize {
        self.storage.capacity()
    }

    /// Return the number of elements this GapBuffer currently holds.
    pub fn len(&self) -> usize {
        self.capacity() - self.gap.len()
    }

    /// Return the current insertion position.
    pub fn position(&self) -> usize {
        self.gap.start
    }

    ...
}
```

It cleans up many of the following functions to have a utility method that returns a raw pointer to the buffer element at a given index. This being Rust, we end up needing one method for `mut` pointers and one for `const`. Unlike the preceding methods, these are not public. Continuing this `impl` block:

```
/// Return a pointer to the `index`'th element of the underlying storage,
/// regardless of the gap.
///
/// Safety: `index` must be a valid index into `self.storage`.
unsafe fn space(&self, index: usize) -> *const T {
    self.storage.as_ptr().offset(index as isize)
}
```

---

<sup>2</sup> There are better ways to handle this using the `RawVec` type from the `alloc` crate, but that crate is still unstable.

```

/// Return a mutable pointer to the `index`'th element of the underlying
/// storage, regardless of the gap.
///
/// Safety: `index` must be a valid index into `self.storage`.
unsafe fn space_mut(&mut self, index: usize) -> *mut T {
    self.storage.as_mut_ptr().offset(index as isize)
}

```

To find the element at a given index, you must consider whether the index falls before or after the gap, and adjust appropriately:

```

/// Return the offset in the buffer of the `index`'th element, taking
/// the gap into account. This does not check whether index is in range,
/// but it never returns an index in the gap.
fn index_to_raw(&self, index: usize) -> usize {
    if index < self.gap.start {
        index
    } else {
        index + self.gap.len()
    }
}

```

```

/// Return a reference to the `index`'th element,
/// or `None` if `index` is out of bounds.
pub fn get(&self, index: usize) -> Option<&T> {
    let raw = self.index_to_raw(index);
    if raw < self.capacity() {
        unsafe {
            // We just checked `raw` against self.capacity(),
            // and index_to_raw skips the gap, so this is safe.
            Some(&*self.space(raw))
        }
    } else {
        None
    }
}

```

When we start making insertions and deletions in a different part of the buffer, we need to move the gap to the new location. Moving the gap to the right entails shifting elements to the left, and vice versa, just as the bubble in a spirit level moves in one direction when the fluid flows in the other:

```

/// Set the current insertion position to `pos`.
/// If `pos` is out of bounds, panic.
pub fn set_position(&mut self, pos: usize) {
    if pos > self.len() {
        panic!("index {} out of range for GapBuffer", pos);
    }

    unsafe {
        let gap = self.gap.clone();
        if pos > gap.start {

```

```

        // `pos` falls after the gap. Move the gap right
        // by shifting elements after the gap to before it.
        let distance = pos - gap.start;
        std::ptr::copy(self.space(gap.end),
                      self.space_mut(gap.start),
                      distance);
    } else if pos < gap.start {
        // `pos` falls before the gap. Move the gap left
        // by shifting elements before the gap to after it.
        let distance = gap.start - pos;
        std::ptr::copy(self.space(pos),
                      self.space_mut(gap.end - distance),
                      distance);
    }

    self.gap = pos .. pos + gap.len();
}
}

```

This function uses the `std::ptr::copy` method to shift the elements; `copy` requires that the destination be uninitialized, and leaves the source uninitialized. The source and destination ranges may overlap, but `copy` handles that case correctly. Since the gap is uninitialized memory before the call, and the function adjusts the gap's position to cover space vacated by the copy, the copy function's contract is satisfied.

Element insertion and removal are relatively simple. Insertion takes over one space from the gap for the new element, whereas removal moves one value out, and enlarges the gap to cover the space it used to occupy:

```

/// Insert `elt` at the current insertion position,
/// and leave the insertion position after it.
pub fn insert(&mut self, elt: T) {
    if self.gap.len() == 0 {
        self.enlarge_gap();
    }

    unsafe {
        let index = self.gap.start;
        std::ptr::write(self.space_mut(index), elt);
    }
    self.gap.start += 1;
}

/// Insert the elements produced by `iter` at the current insertion
/// position, and leave the insertion position after them.
pub fn insert_iter<I>(&mut self, iterable: I)
    where I: IntoIterator<Item=T>
{
    for item in iterable {
        self.insert(item)
    }
}

```



```

/// Remove the element just after the insertion position
/// and return it, or return `None` if the insertion position
/// is at the end of the GapBuffer.
pub fn remove(&mut self) -> Option<T> {
    if self.gap.end == self.capacity() {
        return None;
    }

    let element = unsafe {
        std::ptr::read(self.space(self.gap.end))
    };
    self.gap.end += 1;
    Some(element)
}

```

Similar to the way `Vec` uses `std::ptr::write` for push and `std::ptr::read` for pop, `GapBuffer` uses `write` for insert, and `read` for remove. And just as `Vec` must adjust its length to maintain the boundary between initialized elements and spare capacity, `GapBuffer` adjusts its gap.

When the gap has been filled in, the `insert` method must grow the buffer to acquire more free space. The `enlarge_gap` method (the last in the `impl` block) handles this:

```

/// Double the capacity of `self.storage`.
fn enlarge_gap(&mut self) {
    let mut new_capacity = self.capacity() * 2;
    if new_capacity == 0 {
        // The existing vector is empty.
        // Choose a reasonable starting capacity.
        new_capacity = 4;
    }

    // We have no idea what resizing a Vec does with its "unused"
// capacity. So just create a new vector and move over the elements.
    let mut new = Vec::with_capacity(new_capacity);
    let after_gap = self.capacity() - self.gap.end;
    let new_gap = self.gap.start .. new.capacity() - after_gap;

    unsafe {
        // Move the elements that fall before the gap.
        std::ptr::copy_nonoverlapping(self.space(0),
            new.as_mut_ptr(),
            self.gap.start);

        // Move the elements that fall after the gap.
        let new_gap_end = new.as_mut_ptr().offset(new_gap.end as isize);
        std::ptr::copy_nonoverlapping(self.space(self.gap.end),
            new_gap_end,
            after_gap);
    }
}

```

```

    // This frees the old Vec, but drops no elements,
    // because the Vec's length is zero.
    self.storage = new;
    self.gap = new_gap;
}

```

Whereas `set_position` must use `copy` to move elements back and forth in the gap, `enlarge_gap` can use `copy_nonoverlapping`, since it is moving elements to an entirely new buffer.

Moving the new vector into `self.storage` drops the old vector. Since its length is zero, the old vector believes it has no elements to drop, and simply frees its buffer. Neatly, `copy_nonoverlapping` leaves its source uninitialized, so the old vector is correct in this belief: all the elements are now owned by the new vector.

Finally, we need to make sure that dropping a `GapBuffer` drops all its elements:

```

impl<T> Drop for GapBuffer<T> {
    fn drop(&mut self) {
        unsafe {
            for i in 0 .. self.gap.start {
                std::ptr::drop_in_place(self.space_mut(i));
            }
            for i in self.gap.end .. self.capacity() {
                std::ptr::drop_in_place(self.space_mut(i));
            }
        }
    }
}

```

The elements lie before and after the gap, so we iterate over each region and use the `std::ptr::drop_in_place` function to drop each one. The `drop_in_place` function is a utility that behaves like `drop(std::ptr::read(ptr))`, but doesn't bother moving the value to its caller (and hence works on unsized types). And just as in `enlarge_gap`, by the time the vector `self.storage` is dropped, its buffer really is uninitialized.

Like the other types we've shown in this chapter, `GapBuffer` ensures that its own invariants are sufficient to ensure that the contract of every unsafe feature it uses is followed, so none of its public methods need be marked unsafe. `GapBuffer` implements a safe interface for a feature that cannot be written efficiently in safe code.

## Panic Safety in Unsafe Code

In Rust, panics can't usually cause undefined behavior; the `panic!` macro is not an unsafe feature. But when you decide to work with unsafe code, panic safety becomes part of your job.

Consider the `GapBuffer::remove` method from the previous section:

```
pub fn remove(&mut self) -> Option<T> {
    if self.gap.end == self.capacity() {
        return None;
    }

    let element = unsafe {
        std::ptr::read(self.space(self.gap.end))
    };
    self.gap.end += 1;
    Some(element)
}
```

The call to `read` moves the element immediately after the gap out of the buffer, leaving behind uninitialized space. Fortunately, the very next statement enlarges the gap to cover that space, so by the time we return, everything is as it should be: all elements outside the gap are initialized, and all elements inside the gap are uninitialized.

But consider what would happen if, after the call to `read` but before the adjustment to `self.gap.end`, this code tried to use a feature that might panic—say, indexing a slice. Exiting the method abruptly anywhere between those two actions would leave the `GapBuffer` with an uninitialized element outside the gap. The next call to `remove` could try to read it again; and even simply dropping the `GapBuffer` would try to drop it. Both are undefined behavior, because they access uninitialized memory.

It's all but unavoidable for a type's methods to momentarily relax the type's invariants while they do their job, and then put everything back to rights before they return. A panic mid-method could cut that cleanup process short, leaving the type in an inconsistent state.

If the type uses only safe code, then this inconsistency may make the type misbehave, but it can't introduce undefined behavior. But code using unsafe features is usually counting on its invariants to meet the contracts of those features. Broken invariants lead to broken contracts, which lead to undefined behavior.

When working with unsafe features, you must take special care to identify these sensitive regions, and ensure that they do nothing that might panic.

## Foreign Functions: Calling C and C++ from Rust

Rust's *foreign function interface* lets Rust code call functions written in C or C++.

In this section, we'll write a program that links with `libgit2`, a C library for working with the Git version control system. First, we'll show what it's like to use C functions directly from Rust. Then, we'll show how to construct a safe interface to `libgit2`, taking inspiration from the open source `git2-rs` crate, which does exactly that.

We'll assume that you're familiar with C and the mechanics of compiling and linking C programs. Working with C++ is similar. We'll also assume that you're somewhat familiar with the Git version control system.

## Finding Common Data Representations

The common denominator of Rust and C is machine language, so in order to anticipate what Rust values look like to C code, or vice versa, you need to consider their machine-level representations. Throughout the book, we've made a point of showing how values are actually represented in memory, so you've probably noticed that the data worlds of C and Rust have a lot in common: a Rust `usize` and a C `size_t` are identical, for example, and structs are fundamentally the same idea in both languages. To establish a correspondence between Rust and C types, we'll start with primitives and then work our way up to more complicated types.

Given its primary use as a systems programming language, C has always been surprisingly loose about its types' representations: an `int` is typically 32 bits long, but could be longer, or as short as 16 bits; a C `char` may be signed or unsigned; and so on. To cope with this variability, Rust's `std::os::raw` module defines a set of Rust types that are guaranteed to have the same representation as certain C types. These cover the primitive integer and character types:

C type	Corresponding <code>std::os::raw</code> type
<code>short</code>	<code>c_short</code>
<code>int</code>	<code>c_int</code>
<code>long</code>	<code>c_long</code>
<code>long long</code>	<code>c_longlong</code>
<code>unsigned short</code>	<code>c_ushort</code>
<code>unsigned, unsigned int</code>	<code>c_uint</code>
<code>unsigned long</code>	<code>c_ulong</code>
<code>unsigned long long</code>	<code>c_ulonglong</code>
<code>char</code>	<code>c_char</code>
<code>signed char</code>	<code>c_schar</code>
<code>unsigned char</code>	<code>c_uchar</code>
<code>float</code>	<code>c_float</code>
<code>double</code>	<code>c_double</code>
<code>void *</code> , <code>const void *</code>	<code>*mut c_void</code> , <code>*const c_void</code>

Some notes about the table:

- Except for `c_void`, all the Rust types here are aliases for some primitive Rust type: `c_char`, for example, is either `i8` or `u8`.

- There is no endorsed Rust type corresponding to C's `bool`. At the moment, a Rust `bool` is always either a zero or a one byte, the same representation used by all major C and C++ implementations. However, the Rust language team has not committed to keep this representation in the future, since doing so may close opportunities for optimization.
- Rust's 32-bit `char` type is not the analogue of `wchar_t`, whose width and encoding vary from one implementation to another. C's `char32_t` type is closer, but its encoding is still not guaranteed to be Unicode.
- Rust's primitive `usize` and `isize` types have the same representations as C's `size_t` and `ptrdiff_t`.
- C and C++ pointers and C++ references correspond to Rust's raw pointer types, `*mut T` and `*const T`.
- Technically, the C standard permits implementations to use representations for which Rust has no corresponding type: 36-bit integers, sign-and-magnitude representations for signed values, and so on. In practice, on every platform Rust has been ported to, every common C integer type has a match in Rust, `bool` aside.

For defining Rust struct types compatible with C structs, you can use the `#[repr(C)]` attribute. Placing `#[repr(C)]` above a struct definition asks Rust to lay out the struct's fields in memory the same way a C compiler would lay out the analogous C struct type. For example, `libgit2`'s `git2/errors.h` header file defines the following C struct to provide details about a previously reported error:

```
typedef struct {
    char *message;
    int klass;
} git_error;
```

You can define a Rust type with an identical representation as follows:

```
#[repr(C)]
pub struct git_error {
    pub message: *const c_char,
    pub klass: c_int
}
```

The `#[repr(C)]` attribute affects only the layout of the struct itself, not the representations of its individual fields, so to match the C struct, each field must use the C-like type as well: `*const c_char` for `char *`, and `c_int` for `int`, and so on.

In this particular case, the `#[repr(C)]` attribute probably doesn't change the layout of `git_error`. There really aren't too many interesting ways to lay out a pointer and an integer. But whereas C and C++ guarantee that a structure's members appear in memory in the order they're declared, each at a distinct address, Rust reorders fields to

minimize the overall size of the struct, and zero-sized types take up no space. The `#[repr(C)]` attribute tells Rust to follow C's rules for the given type.

You can also use `#[repr(C)]` to control the representation of C-style enums:

```
#[repr(C)]
enum git_error_code {
    GIT_OK          = 0,
    GIT_ERROR       = -1,
    GIT_ENOTFOUND   = -3,
    GIT_EEXISTS     = -4,
    ...
}
```

Normally, Rust plays all sorts of games when choosing how to represent enums. For example, we mentioned the trick Rust uses to store `Option<T>` in a single word (if `T` is sized). Without `#[repr(C)]`, Rust would use a single byte to represent the `git_error_code` enum; with `#[repr(C)]`, Rust uses a value the size of a C `int`, just as C would.

You can also ask Rust to give an enum the same representation as some integer type. Starting the preceding definition with `#[repr(i16)]` would give you a 16-bit type with the same representation as the following C++ enum:

```
#include <stdint.h>

enum git_error_code: int16_t {
    GIT_OK          = 0,
    GIT_ERROR       = -1,
    GIT_ENOTFOUND   = -3,
    GIT_EEXISTS     = -4,
    ...
};
```

Passing strings between Rust and C is a little harder. C represents a string as a pointer to an array of characters, terminated by a null character. Rust, on the other hand, stores the length of a string explicitly, either as a field of a `String`, or as the second word of a fat reference `&str`. Rust strings are not null-terminated; in fact, they may include null characters in their contents, like any other character.

This means that you can't borrow a Rust string as a C string: if you pass C code a pointer into a Rust string, it could mistake an embedded null character for the end of the string, or run off the end looking for a terminating null that isn't there. Going the other direction, you may be able to borrow a C string as a Rust `&str`, as long as its contents are well-formed UTF-8.

This situation effectively forces Rust to treat C strings as types entirely distinct from `String` and `&str`. In the `std::ffi` module, the `CString` and `CStr` types represent owned and borrowed null-terminated arrays of bytes. Compared to `String` and `str`,

the methods on `CString` and `CStr` are quite limited, restricted to construction and conversion to other types. We'll show these types in action in the next section.

## Declaring Foreign Functions and Variables

An `extern` block declares functions or variables defined in some other library that the final Rust executable will be linked with. For example, every Rust program is linked against the standard C library, so we can tell Rust about the C library's `strlen` function like this:

```
use std::os::raw::c_char;

extern {
    fn strlen(s: *const c_char) -> usize;
}
```

This gives Rust the function's name and type, while leaving the definition to be linked in later.

Rust assumes that functions declared inside `extern` blocks use C conventions for passing arguments and accepting return values. They are defined as `unsafe` functions. These are the right choices for `strlen`: it is indeed a C function; and its specification in C requires that you pass it a valid pointer to a properly terminated string, which is a contract that Rust cannot enforce. (Almost any function that takes a raw pointer must be `unsafe`: safe Rust can construct raw pointers from arbitrary integers, and dereferencing such a pointer would be undefined behavior.)

With this `extern` block, we can call `strlen` like any other Rust function, although its type gives it away as a tourist:

```
use std::ffi::CString;

let rust_str = "I'll be back";
let null_terminated = CString::new(rust_str).unwrap();
unsafe {
    assert_eq!(strlen(null_terminated.as_ptr()), 12);
}
```

The `CString::new` function builds a null-terminated C string. It first checks its argument for embedded null characters, since those cannot be represented in a C string, and returns an error if it finds any (hence the need to `unwrap` the result). Otherwise, it adds a null byte to the end, and returns a `CString` owning the resulting characters.

The cost of `CString::new` depends on what type you pass it. It accepts anything that implements `Into<Vec<u8>>`. Passing a `&str` entails an allocation and a copy, as the conversion to `Vec<u8>` builds a heap-allocated copy of the string for the vector to own. But passing a `String` by value simply consumes the string and takes over its

buffer, so unless appending the null character forces the buffer to be resized, the conversion requires no copying of text or allocation at all.

CString dereferences to CStr, whose `as_ptr` method returns a `*const c_char` pointing at the start of the string. This is the type that `strlen` expects. In the example, `strlen` runs down the string, finds the null character that `CString::new` placed there, and returns the length, as a byte count.

You can also declare global variables in `extern` blocks. POSIX systems have a global variable named `environ` that holds the values of the process's environment variables. In C, it's declared:

```
extern char **environ;
```

In Rust, you would say:

```
use std::ffi::CStr;
use std::os::raw::c_char;

extern {
    static environ: *mut *mut c_char;
}
```

To print the environment's first element, you could write:

```
unsafe {
    if !environ.is_null() && !(*environ).is_null() {
        let var = CStr::from_ptr(*environ);
        println!("first environment variable: {}",
                var.to_string_lossy());
    }
}
```

After making sure `environ` has a first element, the code calls `CStr::from_ptr` to build a `CStr` that borrows it. The `to_string_lossy` method returns a `Cow<str>`: if the C string contains well-formed UTF-8, the `Cow` borrows its content as a `&str`, not including the terminating null byte. Otherwise, `to_string_lossy` makes a copy of the text in the heap, replaces the ill-formed UTF-8 sequences with the official Unicode replacement character, '◆', and builds an owning `Cow` from that. Either way, the result implements `Display`, so you can print it with the `{}` format parameter.

## Using Functions from Libraries

To use functions provided by a particular library, you can place a `#[link]` attribute atop the `extern` block that names the library Rust should link the executable with. For example, here's a program that calls `libgit2`'s initialization and shutdown methods, but does nothing else:



```

use std::os::raw::c_int;

#[link(name = "git2")]
extern {
    pub fn git_libgit2_init() -> c_int;
    pub fn git_libgit2_shutdown() -> c_int;
}

fn main() {
    unsafe {
        git_libgit2_init();
        git_libgit2_shutdown();
    }
}

```

The `extern` block declares the extern functions as before. The `#[link(name = "git2")]` attribute leaves a note in the crate to the effect that, when Rust creates the final executable or shared library, it should link against the `git2` library. Rust uses the system linker to build executables; on Unix, this passes the argument `-lgit2` on the linker command line; on Windows, it passes `git2.LIB`.

`#[link]` attributes work in library crates, too. When you build a program that depends on other crates, Cargo gathers together the link notes from the entire dependency graph, and includes them all in the final link.

In this example, if you would like to follow along on your own machine, you'll need to build `libgit2` for yourself. We used `libgit2` version 0.25.1, available from <https://libgit2.github.com>. To compile `libgit2`, you will need to install the CMake build tool and the Python language; we used CMake version 3.8.0 and Python version 2.7.13, downloaded from <https://cmake.org> and <https://www.python.org>.

The full instructions for building `libgit2` are available on its website, but they're simple enough that we'll show the essentials here. On Linux, assume you've already unzipped the library's source into the directory `/home/jimb/libgit2-0.25.1`:

```

$ cd /home/jimb/libgit2-0.25.1
$ mkdir build
$ cd build
$ cmake ..
$ cmake --build .

```

On Linux, this produces a shared library `/home/jimb/libgit2-0.25.1/build/libgit2.so.0.25.1` with the usual nest of symlinks pointing to it, including one named `libgit2.so`. On macOS, the results are similar, but the library is named `libgit2.dylib`.

On Windows, things are also straightforward. Assume you've unzipped the source into the directory `C:\Users\JimB\libgit2-0.25.1`. In a Visual Studio command prompt:

```

> cd C:\Users\JimB\libgit2-0.25.1
> mkdir build

```

```
> cd build
> cmake -A x64 ..
> cmake --build .
```

These are the same commands as used on Linux, except that you must request a 64-bit build when you run CMake the first time, to match your Rust compiler. (If you have installed the 32-bit Rust toolchain, then you should omit the `-A x64` flag to the first `cmake` command.) This produces an import library `git2.LIB` and a dynamic-link library `git2.DLL`, both in the directory `C:\Users\JimB\libgit2-0.25.1\build\Debug`. (The remaining instructions are shown for Unix, except where Windows is substantially different.)

Create the Rust program in a separate directory:

```
$ cd /home/jimb
$ cargo new --bin git-toy
```

Put the code above in `src/main.rs`. Naturally, if you try to build this, Rust has no idea where to find the `libgit2` you built:

```
$ cd git-toy
$ cargo run
  Compiling git-toy v0.1.0 (file:///home/jimb/git-toy)
error: linking with `cc` failed: exit code: 1
 |
 = note: "cc" ... "-l" "git2" ...
 = note: /usr/bin/ld: cannot find -lgit2
       collect2: error: ld returned 1 exit status
```

```
error: aborting due to previous error
```

```
error: Could not compile `git-toy`.
```

To learn more, run the command again with `--verbose`.

```
$
```

You can tell Rust where to search for libraries by writing a *build script*, Rust code that Cargo compiles and runs at build time. Build scripts can do all sorts of things: generate code dynamically, compile C code to be included in the crate, and so on. In this case, all you need is to add a library search path to the executable's link command. When Cargo runs the build script, it parses the build script's output for information of this sort, so the build script simply needs to print the right magic to its standard output.

To create your build script, add a file named `build.rs` in the same directory as the `Cargo.toml` file, with the following contents:

```
fn main() {
    println!(r"cargo:rustc-link-search=native=/home/jimb/libgit2-0.25.1/build");
}
```

This is the right path for Linux; on Windows, you would change the path following the text `native=` to `C:\Users\JimB\libgit2-0.25.1\build\Debug`. (We're cutting some corners to keep this example simple; in a real application, you should avoid using absolute paths in your build script. We cite documentation that shows how to do it right at the end of this section.)

Next, tell Cargo that this is your build script by adding the line `build = "build.rs"` to the `[package]` section of your *Cargo.toml* file. The entire file should now read:

```
[package]
name = "git-toy"
version = "0.1.0"
authors = ["You <you@example.com>"]
build = "build.rs"

[dependencies]
```

Now you can almost run the program. On macOS it may work immediately; on a Linux system you will probably see something like the following:

```
$ cargo run
  Compiling git-toy v0.1.0 (file:///home/jimb/git-toy)
  Finished dev [unoptimized + debuginfo] target(s) in 0.64 secs
  Running `target/debug/git-toy`
target/debug/git-toy: error while loading shared libraries:
libgit2.so.25: cannot open shared object file: No such file or directory
$
```

This means that, although Cargo succeeded in linking the executable against the library, it doesn't know where to find the shared library at run time. Windows reports this failure by popping up a dialog box. On Linux, you must set the `LD_LIBRARY_PATH` environment variable:

```
$ export LD_LIBRARY_PATH=/home/jimb/libgit2-0.25.1/build:$LD_LIBRARY_PATH
$ cargo run
  Finished dev [unoptimized + debuginfo] target(s) in 0.0 secs
  Running `target/debug/git-toy`
$
```

On macOS, you may need to set `DYLD_LIBRARY_PATH` instead.

On Windows, you must set the `PATH` environment variable:

```
> set PATH=C:\Users\JimB\libgit2-0.25.1\build\Debug;%PATH%
> cargo run
  Finished dev [unoptimized + debuginfo] target(s) in 0.0 secs
  Running `target/debug/git-toy`
>
```

Naturally, in a deployed application you'd want to avoid having to set environment variables just to find your library's code. One alternative is to statically link the C library into your crate. This copies the library's object files into the crate's *.rlib* file,

alongside the object files and metadata for the crate's Rust code. The entire collection then participates in the final link.

It is a Cargo convention that a crate that provides access to a C library should be named `LIB-sys`, where `LIB` is the name of the C library. A `-sys` crate should contain nothing but the statically linked library and Rust modules containing `extern` blocks and type definitions. Higher-level interfaces then belong in crates that depend on the `-sys` crate. This allows multiple upstream crates to depend on the same `-sys` crate, assuming there is a single version of the `-sys` crate that meets everyone's needs.

For the full details on Cargo's support for build scripts and linking with system libraries, see [the online Cargo documentation](#). It shows how to avoid absolute paths in build scripts, control compilation flags, use tools like `pkg-config`, and so on. The `git2-rs` crate also provides good examples to emulate; its build script handles some complex situations.

## A Raw Interface to `libgit2`

Figuring out how to use `libgit2` properly breaks down into two questions:

- What does it take to use `libgit2` functions in Rust?
- How can we build a safe Rust interface around them?

We'll take these questions one at a time. In this section, we'll write a program that's essentially a single giant `unsafe` block filled with nonidiomatic Rust code, reflecting the clash of type systems and conventions that is inherent in mixing languages. We'll call this the *raw* interface. The code will be messy, but it will make plain all the steps that must occur for Rust code to use `libgit2`.

Then, in the next section, we'll build a safe interface to `libgit2` that puts Rust's types to use enforcing the rules `libgit2` imposes on its users. Fortunately, `libgit2` is an exceptionally well-designed C library, so the questions that Rust's safety requirements force us to ask all have pretty good answers, and we can construct an idiomatic Rust interface with no `unsafe` functions.

The program we'll write is very simple: it takes a path as a command-line argument, opens the Git repository there, and prints out the head commit. But this is enough to illustrate the key strategies for building safe and idiomatic Rust interfaces.

For the raw interface, the program will end up needing a somewhat larger collection of functions and types from `libgit2` than we used before, so it makes sense to move the `extern` block into its own module. We'll create a file named `raw.rs` in `git-toy/src` whose contents are as follows:

```
#![allow(non_camel_case_types)]
```

```

use std::os::raw::{c_int, c_char, c_uchar};

#[link(name = "git2")]
extern {
    pub fn git_libgit2_init() -> c_int;
    pub fn git_libgit2_shutdown() -> c_int;
    pub fn giterr_last() -> *const git_error;

    pub fn git_repository_open(out: *mut *mut git_repository,
                               path: *const c_char) -> c_int;
    pub fn git_repository_free(repo: *mut git_repository);

    pub fn git_reference_name_to_id(out: *mut git_oid,
                                     repo: *mut git_repository,
                                     reference: *const c_char) -> c_int;

    pub fn git_commit_lookup(out: *mut *mut git_commit,
                              repo: *mut git_repository,
                              id: *const git_oid) -> c_int;

    pub fn git_commit_author(commit: *const git_commit) -> *const git_signature;
    pub fn git_commit_message(commit: *const git_commit) -> *const c_char;
    pub fn git_commit_free(commit: *mut git_commit);
}

pub enum git_repository {}
pub enum git_commit {}

#[repr(C)]
pub struct git_error {
    pub message: *const c_char,
    pub klass: c_int
}

#[repr(C)]
pub struct git_oid {
    pub id: [c_uchar; 20]
}

pub type git_time_t = i64;

#[repr(C)]
pub struct git_time {
    pub time: git_time_t,
    pub offset: c_int
}

#[repr(C)]
pub struct git_signature {
    pub name: *const c_char,
    pub email: *const c_char,
}

```

```
    pub when: git_time
}
```

Each item here is modeled on a declaration from `libgit2`'s own header files. For example, `libgit2-0.25.1/include/git2/repository.h` includes this declaration:

```
extern int git_repository_open(git_repository **out, const char *path);
```

This function tries to open the Git repository at `path`. If all goes well, it creates a `git_repository` object and stores a pointer to it in the location pointed to by `out`. The equivalent Rust declaration is the following:

```
pub fn git_repository_open(out: *mut *mut git_repository,
                           path: *const c_char) -> c_int;
```

The `libgit2` public header files define the `git_repository` type as a typedef for an incomplete struct type:

```
typedef struct git_repository git_repository;
```

Since the details of this type are private to the library, the public headers never define `struct git_repository`, ensuring that the library's users can never build an instance of this type themselves. One possible analogue to an incomplete struct type in Rust is this:

```
pub enum git_repository {}
```

This is an enum type with no variants. There is no way in Rust to make a value of such a type. This is an oddity, but it's perfect as the reflection of a C type that only `libgit2` should ever construct, and which is manipulated solely through raw pointers.

Writing large `extern` blocks by hand can be a chore. If you are creating a Rust interface to a complex C library, you may want to try using the `bindgen` crate, which has functions you can use from your build script to parse C header files and generate the corresponding Rust declarations automatically. We don't have space to show `bindgen` in action here, but `bindgen`'s page on [crates.io](https://crates.io) includes links to its documentation.

Next we'll rewrite `main.rs` completely. First, we need to declare the `raw` module:

```
mod raw;
```

According to `libgit2`'s conventions, fallible functions return an integer code that is positive or zero on success, and negative on failure. If an error occurs, the `giterr_last` function will return a pointer to a `git_error` structure providing more details about what went wrong. `libgit2` owns this structure, so we don't need to free it ourselves, but it could be overwritten by the next library call we make. A proper Rust interface would use `Result`, but in the `raw` version, we want to use the `libgit2` functions just as they are, so we'll have to roll our own function for handling errors:

```

use std::ffi::CStr;
use std::os::raw::c_int;

fn check(activity: &'static str, status: c_int) -> c_int {
    if status < 0 {
        unsafe {
            let error = &*raw::giterr_last();
            println!("error while {}: {} ({})",
                activity,
                CStr::from_ptr(error.message).to_string_lossy(),
                error.klass);
            std::process::exit(1);
        }
    }
    status
}

```

We'll use this function to check the results of libgit2 calls like this:

```
check("initializing library", raw::git_libgit2_init());
```

This uses the same CStr methods used earlier: `from_ptr` to construct the CStr from a C string, and `to_string_lossy` to turn that into something Rust can print.

Next, we need a function to print out a commit:

```

unsafe fn show_commit(commit: *const raw::git_commit) {
    let author = raw::git_commit_author(commit);

    let name = CStr::from_ptr((*author).name).to_string_lossy();
    let email = CStr::from_ptr((*author).email).to_string_lossy();
    println!("{}", <{}>\n", name, email);

    let message = raw::git_commit_message(commit);
    println!("{}", CStr::from_ptr(message).to_string_lossy());
}

```

Given a pointer to a `git_commit`, `show_commit` calls `git_commit_author` and `git_commit_message` to retrieve the information it needs. These two functions follow a convention that the libgit2 documentation explains as follows:

If a function returns an object as a return value, that function is a getter and the object's lifetime is tied to the parent object.

In Rust terms, `author` and `message` are borrowed from `commit`: `show_commit` doesn't need to free them itself, but it must not hold on to them after `commit` is freed. Since this API uses raw pointers, Rust won't check their lifetimes for us: if we do accidentally create dangling pointers, we probably won't find out about it until the program crashes.

The preceding code assumes these fields hold UTF-8 text, which is not always correct. Git permits other encodings as well. Interpreting these strings properly would probably entail using the `encoding` crate. For brevity's sake, we'll gloss over those issues here.

Our program's `main` function reads as follows:

```
use std::ffi::CString;
use std::mem;
use std::ptr;
use std::os::raw::c_char;

fn main() {
    let path = std::env::args().skip(1).next()
        .expect("usage: git-toy PATH");
    let path = CString::new(path)
        .expect("path contains null characters");

    unsafe {
        check("initializing library", raw::git_libgit2_init());

        let mut repo = ptr::null_mut();
        check("opening repository",
            raw::git_repository_open(&mut repo, path.as_ptr()));

        let c_name = b"HEAD\0".as_ptr() as *const c_char;
        let mut oid = mem::uninitialized();
        check("looking up HEAD",
            raw::git_reference_name_to_id(&mut oid, repo, c_name));

        let mut commit = ptr::null_mut();
        check("looking up commit",
            raw::git_commit_lookup(&mut commit, repo, &oid));

        show_commit(commit);

        raw::git_commit_free(commit);

        raw::git_repository_free(repo);

        check("shutting down library", raw::git_libgit2_shutdown());
    }
}
```

This starts with code to handle the path argument and initialize the library, all of which we've seen before. The first novel code is this:

```
let mut repo = ptr::null_mut();
check("opening repository",
    raw::git_repository_open(&mut repo, path.as_ptr()));
```



The call to `git_repository_open` tries to open the Git repository at the given path. If it succeeds, it allocates a new `git_repository` object for it, and sets `repo` to point to that. Rust implicitly coerces references into raw pointers, so passing `&mut repo` here provides the `*mut *mut git_repository` the call expects.

This shows another `libgit2` convention in use. Again, from the `libgit2` documentation:

Objects which are returned via the first argument as a pointer-to-pointer are owned by the caller and it is responsible for freeing them.

In Rust terms, functions like `git_repository_open` pass ownership of the new value to the caller.

Next, consider the code that looks up the object hash of the repository's current head commit:

```
let mut oid = mem::uninitialized();
check("looking up HEAD",
      raw::git_reference_name_to_id(&mut oid, repo, c_name));
```

The `git_oid` type stores an object identifier—a 160-bit hash code that Git uses internally (and throughout its delightful user interface) to identify commits, individual versions of files, and so on. This call to `git_reference_name_to_id` looks up the object identifier of the current "HEAD" commit.

In C it's perfectly normal to initialize a variable by passing a pointer to it to some function that fills in its value; this is how `git_reference_name_to_id` expects to treat its first argument. But Rust won't let us borrow a reference to an uninitialized variable. We could initialize `oid` with zeros, but this is a waste: any value stored there will simply be overwritten.

Initializing `oid` to `uninitialized()` gets around this problem. The `std::mem::uninitialized` function returns a value of any type you like, except that the value consists entirely of uninitialized bits, and no machine code is actually spent producing the value. Rust, however, considers `oid` to have been assigned some value, so it lets us borrow the reference to it. As you can imagine, in the general case, this is very unsafe. Reading an uninitialized value is undefined behavior, and if any part of the value implements `Drop`, even dropping it is undefined behavior as well. There are only a few safe things you can do:

- You can overwrite it with `std::ptr::write`, which requires its destination to be uninitialized.
- You can pass it to `std::mem::forget`, which takes ownership of its argument and makes it disappear without dropping it (applying this to an initialized value might be a leak).

- You can pass it to a foreign function designed to initialize it, like `git_reference_name_to_id`.

If the call succeeds, then `oid` becomes truly initialized, and all is well. If the call fails, the function doesn't use `oid`, and its type doesn't need to be dropped, so the code is safe in that case too.

We could use `uninitialized` for the `repo` and `commit` variables as well, but since these are just single words and `uninitialized` is so dicey to use, we just go ahead and initialize them to null:

```
let mut commit = ptr::null_mut();
check("looking up commit",
      raw::git_commit_lookup(&mut commit, repo, &oid));
```

This takes the commit's object identifier and looks up the actual commit, storing a `git_commit` pointer in `commit` on success.

The remainder of the `main` function should be self-explanatory. It calls the `show_commit` function defined earlier, frees the commit and repository objects, and shuts down the library.

Now we can try out the program on any Git repository ready at hand:

```
$ cargo run /home/jimb/rbattle
  Finished dev [unoptimized + debuginfo] target(s) in 0.0 secs
  Running `target/debug/git-toy /home/jimb/rbattle`
Jim Blandy <jimb@red-bean.com>

Animate goop a bit.

$
```

## A Safe Interface to `libgit2`

The raw interface to `libgit2` is a perfect example of an unsafe feature: it certainly can be used correctly (as we do here, so far as we know), but Rust can't enforce the rules you must follow. Designing a safe API for a library like this is a matter of identifying all these rules, and then finding ways to turn any violation of them into a type or borrow-checking error.

Here, then, are `libgit2`'s rules for the features the program uses:

- You must call `git_libgit2_init` before using any other library function. You must not use any library function after calling `git_libgit2_shutdown`.
- All values passed to `libgit2` functions must be fully initialized, except for output parameters.

- When a call fails, output parameters passed to hold the results of the call are left uninitialized, and you must not use their values.
- A `git_commit` object refers to the `git_repository` object it is derived from, so the former must not outlive the latter. (This isn't spelled out in the `libgit2` documentation; we inferred it from the presence of certain functions in the interface, and then verified it by reading the source code.)
- Similarly, a `git_signature` is always borrowed from a given `git_commit`, and the former must not outlive the latter. (The documentation does cover this case.)
- The message associated with a commit and the name and email address of the author are all borrowed from the commit, and must not be used after the commit is freed.
- Once a `libgit2` object has been freed, it must never be used again.

As it turns out, you can build a Rust interface to `libgit2` that enforces all of these rules, either through Rust's type system, or by managing details internally.

Before we get started, let's restructure the project a little bit. We'd like to have a `git` module that exports the safe interface, of which the raw interface from the previous program is a private submodule.

The whole source tree will look like this:

```

git-toy/
├── Cargo.toml
├── build.rs
└── src/
    ├── main.rs
    └── git/
        ├── mod.rs
        └── raw.rs

```

Following the rules we explained in [“Modules in Separate Files” on page 166](#), the source for the `git` module appears in `git/mod.rs`, and the source for its `git::raw` submodule goes in `git/raw.rs`.

Once again, we're going to rewrite `main.rs` completely. It should start with a declaration of the `git` module:

```
mod git;
```

Then, we'll need to create the `git` subdirectory, and move `raw.rs` into it:

```

$ cd /home/jimb/git-toy
$ mkdir src/git
$ mv src/raw.rs src/git/raw.rs

```

The `git` module needs to declare its `raw` submodule. The file `src/git/mod.rs` must say:

```
mod raw;
```

Since it's not pub, this submodule is not visible to the main program.

In a bit we'll need to use some functions from the `libc` crate, so we must add a dependency in `Cargo.toml`. The full file now reads:

```
[package]
name = "git-toy"
version = "0.1.0"
authors = ["Jim Blandy <jimb@red-bean.com>"]
build = "build.rs"

[dependencies]
libc = "0.2.23"
```

The corresponding `extern crate` item must appear in `src/main.rs`:

```
extern crate libc;
```

Now that we've restructured our modules, let's consider error handling. Even `libgit2`'s initialization function can return an error code, so we'll need to have this sorted out before we can get started. An idiomatic Rust interface needs its own `Error` type that captures the `libgit2` failure code as well as the error message and class from `giterr_last`. A proper error type must implement the usual `Error`, `Debug`, and `Display` traits. Then, it needs its own `Result` type that uses this `Error` type. Here are the necessary definitions in `src/git/mod.rs`:

```
use std::error;
use std::fmt;
use std::result;

#[derive(Debug)]
pub struct Error {
    code: i32,
    message: String,
    class: i32
}

impl fmt::Display for Error {
    fn fmt(&self, f: &mut fmt::Formatter) -> result::Result<(), fmt::Error> {
        // Displaying an `Error` simply displays the message from libgit2.
        self.message.fmt(f)
    }
}

impl error::Error for Error {
    fn description(&self) -> &str { &self.message }
}

pub type Result<T> = result::Result<T, Error>;
```

To check the result from raw library calls, the module needs a function that turns a `libgit2` return code into a `Result`:

```
use std::os::raw::c_int;
use std::ffi::CStr;

fn check(code: c_int) -> Result<c_int> {
    if code >= 0 {
        return Ok(code);
    }

    unsafe {
        let error = raw::giterr_last();

        // libgit2 ensures that (*error).message is always non-null and null
        // terminated, so this call is safe.
        let message = CStr::from_ptr((*error).message)
            .to_string_lossy()
            .into_owned();

        Err(Error {
            code: code as i32,
            message,
            class: (*error).klass as i32
        })
    }
}
```

The main difference between this and the `check` function from the raw version is that this constructs an `Error` value instead of printing an error message and exiting immediately.

Now we're ready to tackle `libgit2` initialization. The safe interface will provide a `Repository` type that represents an open Git repository, with methods for resolving references, looking up commits, and so on. Continuing in `git/mod.rs`, here's the definition of `Repository`:

```
/// A Git repository.
pub struct Repository {
    // This must always be a pointer to a live `git_repository` structure.
    // No other `Repository` may point to it.
    raw: *mut raw::git_repository
}
```

A `Repository`'s `raw` field is not public. Since only code in this module can access the `raw::git_repository` pointer, getting this module right should ensure the pointer is always used correctly.

If the only way to create a `Repository` is to successfully open a fresh Git repository, that will ensure that each `Repository` points to a distinct `git_repository` object:

```

use std::path::Path;

impl Repository {
    pub fn open<P: AsRef<Path>>(path: P) -> Result<Repository> {
        ensure_initialized();

        let path = path_to_cstring(path.as_ref())?;
        let mut repo = null_mut();
        unsafe {
            check(raw::git_repository_open(&mut repo, path.as_ptr()))?;
        }
        Ok(Repository { raw: repo })
    }
}

```

Since the only way to do anything with the safe interface is to start with a `Repository` value, and `Repository::open` starts with a call to `ensure_initialized`, we can be confident that `ensure_initialized` will be called before any `libgit2` functions. Its definition is as follows:

```

use std;
use libc;

fn ensure_initialized() {
    static ONCE: std::sync::Once = std::sync::ONCE_INIT;
    ONCE.call_once(|| {
        unsafe {
            check(raw::git_libgit2_init())
                .expect("initializing libgit2 failed");
            assert_eq!(libc::atexit(shutdown), 0);
        }
    });
}

use std::io::Write;

extern fn shutdown() {
    unsafe {
        if let Err(e) = check(raw::git_libgit2_shutdown()) {
            let _ = writeln!(std::io::stderr(),
                "shutting down libgit2 failed: {}",
                e);
            std::process::abort();
        }
    }
}

```

The `std::sync::Once` type helps run initialization code in a thread-safe way. Only the first thread to call `ONCE.call_once` runs the given closure. Any subsequent calls, by this thread or any other, block until the first has completed and then return immediately, without running the closure again. Once the closure has finished, calling

`ONCE.call_once` is cheap, requiring nothing more than an atomic load of a flag stored in `ONCE`.

In the preceding code, the initialization closure calls `git_libgit2_init` and checks the result. It punts a bit and just uses `expect` to make sure initialization succeeded, instead of trying to propagate errors back to the caller.

To make sure the program calls `git_libgit2_shutdown`, the initialization closure uses the C library's `atexit` function, which takes a pointer to a function to invoke before the process exits. Rust closures cannot serve as C function pointers: a closure is a value of some anonymous type carrying the values of whatever variables it captures, or references to them; a C function pointer is just a pointer. However, Rust fn types work fine, as long as you declare them `extern` so that Rust knows to use the C calling conventions. The local function `shutdown` fits the bill, and ensures `libgit2` gets shut down properly.

In “Unwinding” on page 146, we mentioned that it is undefined behavior for a panic to cross language boundaries. The call from `atexit` to `shutdown` is such a boundary, so it is essential that `shutdown` not panic. This is why `shutdown` can't simply use `.expect` to handle errors reported from `raw::git_libgit2_shutdown`. Instead, it must report the error and terminate the process itself. POSIX forbids calling `exit` within an `atexit` handler, so `shutdown` calls `std::process::abort` to terminate the program abruptly.

It might be possible to arrange to call `git_libgit2_shutdown` sooner—say, when the last `Repository` value is dropped. But no matter how we arrange things, calling `git_libgit2_shutdown` must be the safe API's responsibility. The moment it is called, any extant `libgit2` objects become unsafe to use, so a safe API must not expose this function directly.

A `Repository`'s `raw` pointer must always point to a live `git_repository` object. This implies that the only way to close a repository is to drop the `Repository` value that owns it:

```
impl Drop for Repository {
    fn drop(&mut self) {
        unsafe {
            raw::git_repository_free(self.raw);
        }
    }
}
```

By calling `git_repository_free` only when the sole pointer to the `raw::git_repository` is about to go away, the `Repository` type also ensures the pointer will never be used after it's freed.

The `Repository::open` method uses a private function called `path_to_cstring`, which has two definitions—one for Unix-like systems, and one for Windows:

```
use std::ffi::CString;

#[cfg(unix)]
fn path_to_cstring(path: &Path) -> Result<CString> {
    // The `as_bytes` method exists only on Unix-like systems.
    use std::os::unix::ffi::OsStrExt;

    Ok(CString::new(path.as_os_str().as_bytes())?)
}

#[cfg(windows)]
fn path_to_cstring(path: &Path) -> Result<CString> {
    // Try to convert to UTF-8. If this fails, libgit2 can't handle the path
    // anyway.
    match path.to_str() {
        Some(s) => Ok(CString::new(s)?),
        None => {
            let message = format!("Couldn't convert path '{}' to UTF-8",
                path.display());
            Err(message.into())
        }
    }
}
```

The `libgit2` interface makes this code a little tricky. On all platforms, `libgit2` accepts paths as null-terminated C strings. On Windows, `libgit2` assumes these C strings hold well-formed UTF-8 and converts them internally to the 16-bit paths Windows actually requires. This usually works, but it's not ideal. Windows permits filenames that are not well-formed Unicode, and thus cannot be represented in UTF-8. If you have such a file, it's impossible to pass its name to `libgit2`.

In Rust, the proper representation of a filesystem path is a `std::path::Path`, carefully designed to handle any path that can appear on Windows or POSIX. This means that there are `Path` values on Windows that one cannot pass to `libgit2`, because they are not well-formed UTF-8. So although `path_to_cstring`'s behavior is less than ideal, it's actually the best we can do given `libgit2`'s interface.

The two `path_to_cstring` definitions just shown rely on conversions to our `Error` type: the `?` operator attempts such conversions, and the Windows version explicitly calls `.into()`. These conversions are unremarkable:

```
impl From<String> for Error {
    fn from(message: String) -> Error {
        Error { code: -1, message, class: 0 }
    }
}
```



```

// NulError is what `CString::new` returns if a string
// has embedded zero bytes.
impl From<std::ffi::NulError> for Error {
    fn from(e: std::ffi::NulError) -> Error {
        Error { code: -1, message: e.to_string(), class: 0 }
    }
}

```

Next, let's figure out how to resolve a Git reference to an object identifier. Since an object identifier is just a 20 byte hash value, it's perfectly fine to expose it in the safe API:

```

/// The identifier of some sort of object stored in the Git object
/// database: a commit, tree, blob, tag, etc. This is a wide hash of the
/// object's contents.
pub struct Oid {
    pub raw: raw::git_oid
}

```

We'll add a method to Repository to perform the lookup:

```

use std::mem::uninitialized;
use std::os::raw::c_char;

impl Repository {
    pub fn reference_name_to_id(&self, name: &str) -> Result<Oid> {
        let name = CString::new(name)?;
        unsafe {
            let mut oid = uninitialized();
            check(raw::git_reference_name_to_id(&mut oid, self.raw,
                                                name.as_ptr() as *const c_char))?;
            Ok(Oid { raw: oid })
        }
    }
}

```

Although `oid` is left uninitialized when the lookup fails, this function guarantees that its caller can never see the uninitialized value simply by following Rust's `Result` idiom: either the caller gets an `Ok` carrying a properly initialized `Oid` value, or it gets an `Err`.

Next, the module needs a way to retrieve commits from the repository. We'll define a `Commit` type as follows:

```

use std::marker::PhantomData;

pub struct Commit<'repo> {
    // This must always be a pointer to a usable `git_commit` structure.
    raw: *mut raw::git_commit,
    _marker: PhantomData<&'repo Repository>
}

```

As we mentioned earlier, a `git_commit` object must never outlive the `git_repository` object it was retrieved from. Rust's lifetimes let the code capture this rule precisely.

The `RefWithFlag` example earlier in this chapter used a `PhantomData` field to tell Rust to treat a type as if it contained a reference with a given lifetime, even though the type apparently contained no such reference. The `Commit` type needs to do something similar. In this case, the `_marker` field's type is `PhantomData<&'repo Repository>`, indicating that Rust should treat `Commit<'repo>` as if it held a reference with lifetime `'repo` to some `Repository`.

The method for looking up a commit is as follows:

```
use std::ptr::null_mut;

impl Repository {
    pub fn find_commit(&self, oid: &Oid) -> Result<Commit> {
        let mut commit = null_mut();
        unsafe {
            check(raw::git_commit_lookup(&mut commit, self.raw, &oid.raw))?;
        }
        Ok(Commit { raw: commit, _marker: PhantomData })
    }
}
```

How does this relate the `Commit`'s lifetime to the `Repository`'s? The signature of `find_commit` omits the lifetimes of the references involved according to the rules outlined in [“Omitting Lifetime Parameters” on page 112](#). If we were to write the lifetimes out, the full signature would read:

```
fn find_commit<'repo, 'id>(&'repo self, oid: &'id Oid)
    -> Result<Commit<'repo>>
```

This is exactly what we want: Rust treats the returned `Commit` as if it borrows something from `self`, which is the `Repository`.

When a `Commit` is dropped, it must free its `raw::git_commit`:

```
impl<'repo> Drop for Commit<'repo> {
    fn drop(&mut self) {
        unsafe {
            raw::git_commit_free(self.raw);
        }
    }
}
```

From a `Commit`, you can borrow a `Signature` (a name and email address) and the text of the commit message:

```
impl<'repo> Commit<'repo> {
    pub fn author(&self) -> Signature {
        unsafe {
            Signature {
```

```

        raw: raw::git_commit_author(self.raw),
        _marker: PhantomData
    }
}

pub fn message(&self) -> Option<&str> {
    unsafe {
        let message = raw::git_commit_message(self.raw);
        char_ptr_to_str(self, message)
    }
}
}

```

Here's the Signature type:

```

pub struct Signature<'text> {
    raw: *const raw::git_signature,
    _marker: PhantomData<&'text str>
}

```

A `git_signature` object always borrows its text from elsewhere; in particular, signatures returned by `git_commit_author` borrow their text from the `git_commit`. So our safe `Signature` type includes a `PhantomData<&'text str>` to tell Rust to behave as if it contained a `&str` with a lifetime of `'text`. Just as before, `Commit::author` properly connects this `'text` lifetime of the `Signature` it returns to that of the `Commit` without us needing to write a thing. The `Commit::message` method does the same with the `Option<&str>` holding the commit message.

A `Signature` includes methods for retrieving the author's name and email address:

```

impl<'text> Signature<'text> {
    /// Return the author's name as a &str,
    /// or None if it is not well-formed UTF-8.
    pub fn name(&self) -> Option<&str> {
        unsafe {
            char_ptr_to_str(self, (*self.raw).name)
        }
    }

    /// Return the author's email as a &str,
    /// or None if it is not well-formed UTF-8.
    pub fn email(&self) -> Option<&str> {
        unsafe {
            char_ptr_to_str(self, (*self.raw).email)
        }
    }
}
}

```

The preceding methods depend on a private utility function `char_ptr_to_str`:

```
/// Try to borrow a `&str` from `ptr`, given that `ptr` may be null or
/// refer to ill-formed UTF-8. Give the result a lifetime as if it were
/// borrowed from `_owner`.
///
/// Safety: if `ptr` is non-null, it must point to a null-terminated C
/// string that is safe to access.
unsafe fn char_ptr_to_str<T>(_owner: &T, ptr: *const c_char) -> Option<&str> {
    if ptr.is_null() {
        return None;
    } else {
        CString::from_ptr(ptr).to_str().ok()
    }
}
```

The `_owner` parameter's value is never used, but its lifetime is. Making the lifetimes in this function's signature explicit gives us:

```
fn char_ptr_to_str<'o, T: 'o>(_owner: &'o T, ptr: *const c_char)
    -> Option<&'o str>
```

The `CString::from_ptr` function returns a `&CString` whose lifetime is completely unbounded, since it was borrowed from a dereferenced raw pointer. Unbounded lifetimes are almost always inaccurate, so it's good to constrain them as soon as possible. Including the `_owner` parameter causes Rust to attribute its lifetime to the return value's type, so callers can receive a more accurately bounded reference.

It is not clear from the `libgit2` documentation whether a `git_signature`'s email and author pointers can be null, and this despite the documentation for `libgit2` being quite good. Your authors dug around in the source code for some time without being able to persuade themselves one way or the other, and finally decided that `char_ptr_to_str` had better be prepared for null pointers just in case. In Rust, this sort of question is answered immediately by the type: if it's `&str`, you can count on the string to be there; if it's `Option<&str>`, it's optional.

Finally, we've provided safe interfaces for all the functionality we need. The new main function in `src/main.rs` is slimmed down quite a bit, and looks like real Rust code:

```
fn main() {
    let path = std::env::args_os().skip(1).next()
        .expect("usage: git-toy PATH");

    let repo = git::Repository::open(&path)
        .expect("opening repository");

    let commit_oid = repo.reference_name_to_id("HEAD")
        .expect("looking up 'HEAD' reference");

    let commit = repo.find_commit(&commit_oid)
        .expect("looking up commit");
```

```
let author = commit.author();
println!("{}", <{}>\n",
        author.name().unwrap_or("none"),
        author.email().unwrap_or("none"));

println!("{}", commit.message().unwrap_or("none"));
}
```

In this section, we've built a safe API on an unsafe API by arranging for any violation of the latter's contract to be a Rust type error. The result is an interface that Rust can ensure you are using correctly. For the most part, the rules we've made Rust enforce are simply the sorts of rules that C and C++ programmers end up imposing on themselves anyway. What makes Rust feel so much stricter than C and C++ is not that the rules are so foreign, but that that enforcement is mechanical and comprehensive.

## Conclusion

Rust is not a simple language. Its goal is to span two very different worlds. It's a modern programming language, safe by design, with conveniences like closures and iterators; yet it aims to put you in control of the raw capabilities of the machine it runs on, with minimal runtime overhead.

The contours of the language are determined by these goals. Rust manages to bridge most of the gap with safe code. Its borrow checker and zero-cost abstractions put you as close to the bare metal as possible without risking undefined behavior. When that's not enough, or when you want to leverage existing C code, unsafe code stands ready. But again, the language doesn't just offer you these unsafe features and wish you luck. The goal is always to use unsafe features to build safe APIs. That's what we did with `libgit2`. It's also what the Rust team has done with `Box`, `Vec`, the other collections, channels, and more: the standard library is full of safe abstractions, implemented with some unsafe code behind the scenes.

A language with Rust's ambitions was, perhaps, not destined to be the simplest of tools. But Rust is safe, fast, concurrent—and effective. Use it to build large, fast, secure, robust systems that take advantage of the full power of the hardware they run on. Use it to make software better.



## Symbols

- ! operator, 269
- ! type, 134
- != operator, 272
- #!, 177
- #[cfg] attribute, 176, 452
- #[inline] attribute, 176
- #[link] attribute, 562
- \$ (command prompt), 8
- & operator, 15, 97
- & pattern, 227
- &mut operator, 97
- &mut [T] type, 57
- &str (string slice), 66
- &[T] type, 57
- \* operator, 15, 97, 137, 258
- \* wildcard, 186
- \*const T, 57
- \*mut T, 57
- + operator, 270, 400
- operator, 137, 269
- . operator, 98
- /// (documentation comments), 28
- <T>, 55
- = operator, 138
- == operator, 272
- ? operator, 152
- @ patterns, 230
- [T; N] type, 57
- [t] slices, 62
  - (see also slices)
- | (vertical bar), 229

## A

- aborting, 147
- absolute path, 167
- adapter methods
  - by\_ref, 342
  - chain, 341
  - cloned, 344
  - cycle, 344
  - enumerate, 341
  - filter\_map and flat\_map adapters, 332
  - fuse, 338
  - inspect, 340
  - iterators, 330
  - map and filter, 330
  - peekable, 337
  - reversible iterators and rev, 339
  - scan adapter, 335
  - skip and skip\_while, 336
  - take and take\_while, 335
  - zip, 342
- ahead-of-time compilation, 43
- alignment, raw pointers, 544
- all method, 348
- any method, 348
- Arc pointer type, 90
- arguments
  - passing references as, 107
  - referring to by index or name, 419
- Arguments type, 423
- arithmetic operators, 137, 266
  - binary operators, 269
  - compound assignment operators, 270
- arrays
  - basics, 58

- raw pointers, 545
  - slices and, 62
  - tuples vs., 54
- arrays of arrays, 367
- as operator, 49, 540
- ASCII, 392
- Ascii string type
  - unsafe code for conversion into String, 529
  - unsafe functions, 531
- AsMut trait, 294
- AsRef trait, 294
- assert! macro, 10
- assert\_eq! macro, 499
- assignment
  - expressions, 138
  - in Python, 77
  - in Rust, 80
  - moves and (see moves)
  - references, 98
  - to a variable, 82
- associated functions, 199
- associated types, 254
- atomic types, 494
- attributes, 12, 175

## B

- backpressure, 479
- binary input/output, 444
- binary operators, 137, 269
- binary trees, populating with patterns, 232
- BinaryHeap<T> collection type
  - about, 377
  - defined, 361
- bitwise integer operators, 138
- bitwise operators
  - binary operators, 269
  - compound assignment operators, 270
- blocks, 124
  - declarations in, 126
  - unsafe, 527
- Boolean type (bool), 51, 127
- Borrow trait, 296
- borrowing
  - and iteration, 15
  - arbitrary expressions and, 100
  - defined, 2, 93
  - local variables and, 101
- BorrowMut trait, 297
- bounds, reverse-engineering, 260

- Box<T>, 75
- boxes, 56
- break expressions, 131
- BTreeMap<K, V> collection type
  - about, 378
  - defined, 361
  - entries, 381
  - map iteration, 383
- BTreeSet<T> collection type, 384
  - defined, 361
  - iteration, 384
  - methods when "equal" values are different, 385
  - whole-set operations, 385
- buddy traits, 258
- buffered readers, 435
- BufRead trait, 431
- bugs, unsafe code and, 532
- build script, 564
- BuildHasher trait, 388
- byte literals, 48
- byte strings, 65
- by\_ref adapter, 342

## C

### C

- calling from Rust (see foreign functions)
- lack of type safety, 4
- passing strings between Rust and, 560
- type representation, 558

### C++

- assignment in, 79
- calling from Rust (see foreign functions)
- lack of type safety, 4
- macros, 500, 504
- mutexes, 485
- reference creation in, 97

- callbacks, closures and, 316
- cancellation, atomics and, 494
- capacity of a vector, 364
- Cargo, 8
  - build script, 564
  - creating new Rust package with, 8
  - documentation, 181
  - src/bin directory, 174
  - versioning, 186
- cargo build, 162
- cargo doc, 181
- cargo package, 188



- cargo test, 178
- Cargo.lock, 187
- case conversion
  - for characters, 396
  - for strings, 406
- casts, 139
- Cell<T> struct, 206
- Cells, 206
- chain adapter, 341
- channels, 470
  - features and performance, 478
  - multi-producer channels using mutex, 490
  - non-pipeline uses, 483
  - optimization, 478
  - piping iterator to, 482
  - receiving values, 475
  - running pipeline, 476
  - sending values, 472
  - thread safety with Send and Sync, 479
- char type, 52, 394
- character literals, 52
- characters (char), 394
  - case conversion, 396
  - classifying, 395
  - digits, 395
  - integer conversion, 396
  - numeric types vs., 47
- child process, 443
- Clone trait, 287
- cloned adapter, 344
- closures, 140, 303
  - "that kill", 312
  - borrowing references, 306
  - callbacks, 316
  - capturing variables, 305
  - defined, 38
  - dropping values, 312
  - effective use of, 319
  - FnMut, 314
  - FnOnce, 312
  - inspect adapter and, 340
  - layout in memory, 310
  - moves with, 306
  - performance, 310
  - safety, 311
  - types, 308
- code, unsafe (see unsafe code)
- coherence rule, 249
- collections, 359
  - BinaryHeap<T>, 377
  - BTreeMap<K, V>, 378
  - BTreeSet<T>, 384
  - hashing, 387
  - HashMap<K, V>, 378
  - HashSet<T>, 384
  - LinkedList<T>, 376
  - strings as generic collections, 412
  - summary of standard collections, 360
  - Vec<T>, 361
  - VecDeque<T>, 374
- command prompt (\$), 8
- command-line arguments, 12, 28
- community, Rust, 191
- comparison operators, 138
  - references and, 99
  - with iterators, 347
  - with strings, 68
- compiler, 8
- complex numbers, 31
- compound assignment operators, 270
- compression, 444
- concurrency/concurrent programming, 2, 457
  - channels, 470
  - fork-join parallelism, 459
  - Mandelbrot set, 35
  - max\_by and min\_by methods, 346
  - Rust's support for, 23, 72
  - Rust's type safety and, 5
  - shared mutable state, 484
- condition (with if statement), 127
- conditional variables (Condvar), 493
- constants, 171
- consuming iterators, 345
  - and all methods, 348
  - collect method, 351
  - comparing item sequences, 347
  - count method, 345
  - Extend trait, 353
  - find method, 351
  - fold method, 349
  - FromIterator trait, 351
  - last method, 350
  - max\_by\_key and min\_by\_key methods, 347
  - min and max methods, 346
  - nth method, 350
  - partition method, 353
  - position, rposition, and ExactSizeIterator, 348

- product method, 345
- simple accumulation, 345
- sum method, 345
- contracts
  - bugs and, 532
  - unsafe features and, 527
  - unsafe traits and, 536
- Copy types, 86, 289
- count method, 345
- Cow (clone on write) type, 300, 410
- crates, 161
  - #[inline] attribute, 176
  - doc-tests, 182
  - for libraries, 172
  - publishing to crates.io, 188
  - specifying dependencies, 185
  - src/bin directory and, 174
  - workspaces, 190
- crates.io, 188
- critical section, 485
- Cursor, 442
- cycle adapter, 344

## D

- dangling pointer, 71
- data races
  - mutexes and, 485
  - Rust's ability to prevent, 2, 5
  - Rust's mechanisms for avoiding, 23
  - safety and, 41
- deadlock, 489
- Debug trait, 408
- debugging
  - formatting pointers for, 419
  - formatting values for, 418
  - macros, 508
- declarations, 126, 561
- default implementation, 246
- Default trait, 292
- dependencies
  - Cargo.lock, 187
  - in crate context, 163
  - specifying, 185
  - versions and, 186
- deque, 374
  - (see also `VecDeque<T>` collection type)
- deref coercions, 140
- Deref trait, 289
- dereferencing, 15

- \* operator, 97
  - raw pointers, 57, 539-540
- DerefMut trait, 289
- digits, handling, 395
- directionality of text, 394
- directories
  - modules and, 166
  - reading, 450
  - src/bin, 174
- Display trait, 407
- divergent function, 134
- doc comments, 181
- doc-tests, 182
- documentation, 8, 181
- documentation comments, 28
- drain method, 327
- drop trait, 282
- dropping values
  - and ownership, 74
  - FnOnce, 312
  - in closures, 312
  - in Rust, 77

## E

- elements, expressions and, 135
- empty statements, 125
- entries, defined, 378
- Entry type, 381
- enumerate adapter
  - about, 341
  - zip and, 342
- enums, 211, 233
  - C-style, 212
  - defined, 27
  - generic, 218
  - hash implementation, 387
  - implementing rich data structures with, 216
  - in memory, 215
  - with data, 214
- equality operators, 272
- error handling, 145
  - across threads, 463
  - catching errors, 148
  - channels and, 474
  - declaring a custom error type, 157
  - errors that “can’t happen”, 155
  - ignoring errors, 156
  - in `main()`, 156
  - panic, 145

- printing errors, 150
- propagating errors, 152
- Result type, 148
- Result type aliases, 150
- Result vs. exceptions, 158
- unsafe code and, 574
- with multiple error types, 153
- ExactSizeliterator trait, 349
- exceptions, Result vs., 158
- exclusive (half-open) ranges, 136, 229
- expression language, Rust as, 123
- expressions, 123
  - assignment, 138
  - blocks and semicolons, 124
  - closures, 140
  - declarations, 126
  - fields and elements, 135
  - function/method calls, 134
  - if and match, 127
  - if let, 129
  - loops, 130
  - precedence and associativity, 140
  - reference operators, 137
  - return, 132
  - Rust as expression language, 123
  - statements vs., 123
  - syntax, 140
  - type casts, 139
- Extend trait, 353
- extension traits, 248
- extern blocks, 172, 561

## F

- fat pointer, 62, 101
- fields, expressions and, 135
- files
  - opening for readers/writers, 441
  - Seek trait, 441
- files and directories, 445
  - filesystem access functions, 449
  - OsStr and Path, 445
  - Path and PathBuf methods, 447
  - platform-specific features, 451
  - reading directories, 450
- filesystem access functions, 449
- filter adapter, 330
- filter\_map adapter, 332
- find method, 351
- flate2 crate, 444

- flat\_map adapter, 333
- floating-point literals, 50
- floating-point types, 50
- flow-sensitive analyses, 133
- Flux, 320
- fmt method, 421
- fn keyword, 10, 127
- Fn trait, 315
- FnMut trait, 314
- FnOnce trait, 312
- fold method, 349
- for loop, 130
- foreign functions, 557
  - declaring foreign functions and variables, 561
  - finding common data representations, 558
  - from libraries, 562
  - raw interface to libgit2, 566
  - safe interface to libgit2, 572
- fork-join parallelism, 459
  - advantages of, 460
  - error handling across threads, 463
  - Mandelbrot set rendering, 468
  - Rayon library, 466
  - sharing immutable data across threads, 464
  - spawn and join, 461
- format parameters, 413
- formatting values
  - dynamic widths and precisions, 420
  - for debugging, 418
  - implementing traits for, 421
  - numbers, 415
  - pointers for debugging, 419
  - referring to arguments by index or name, 419
  - strings and text, 413
  - text values, 414
  - using formatting language in your own code, 423
  - various standard library types, 417
- format\_args! macro, 423
- free functions, 199
- From trait, 297
- fully qualified method calls, 252
- functions
  - calling, 134
  - declaring, with foreign functions, 561
  - syntax for, 10
  - types, 308

- unsafe, 531
- fuse adapter, 338

## G

- GapBuffer, 550
- garbage collection
  - closures and, 305
  - pointers and, 55, 71
- generic code
  - Intolterator and, 327
  - trait objects vs., 243
- generic collections, strings as, 412
- generic enums, 218
- generic functions, 29, 44, 240
- generic structs, 26, 202
- generic swaps, 55
- generic traits, 257
- generics
  - defined, 236
  - reverse-engineering bounds, 260
- global variables, 496
- guards, 229

## H

- half-open ranges, 136, 229
- hashing
  - collections and, 387
  - using a custom algorithm, 388
- HashMap<K, V> collection type
  - about, 378
  - defined, 361
  - entries, 381
  - map iteration, 383
- HashSet<T> collection type, 384
  - defined, 361
  - iteration, 384
  - methods when "equal" values are different, 385
  - whole-set operations, 385
- hexadecimals, 52
- hygiene, macros and, 516

## I

- if expressions, 127
- if let expressions, 129
- image files, for Mandelbrot set, 33
- immutable references, 56
- impl block, 171, 198

- imports, 167
- Index trait, 277
- indexed content, 84
- IndexMut trait, 277
- infinite loops, 130
- inlining, 310
- input and output, 431
  - files and directories, 445
    - (see also files and directories)
  - networking, 453
  - readers and writers, 432
    - (see also readers, writers)
- inspect adapter, 340
- installation, Rust, 7
- integer literals, 48, 223
- integer types, 47
- integers, converting characters to/from, 396
- integration tests, 180
- interior mutability
  - defined, 92
  - structs, 205
- Into trait, 297
- Intolterator trait, 322
  - implementations, 325
  - implementing for your own types, 354
- invalidation errors, 373
- invariants, 485
- inverted index, 472
- irrefutable patterns, 231
- isize type, 47
- item declarations, 127
- items, 170
  - attributes, 175
  - defined, 165
- iter method, 324
- iterable type, 323
- iterating
  - over a map, 383
  - over text, 403
- Iterator trait
  - implementing for your own types, 354
  - standard, 254
- iterators, 321
  - adapter methods, 330
  - and associated types, 254
  - by\_ref adapter, 342
  - chain adapter, 341
  - cloned adapter, 344
  - consuming, 345

- creating, 324
- cycle adapter, 344
- defined, 14
- drain methods, 327
- enumerate adapter, 341
- filter\_map and flat\_map adapters, 332
- fuse adapter, 338
- implementing for your own types, 354
- in standard library, 328
- inspect adapter, 340
- IntoIterator implementations, 325
- iter and iter\_mut methods, 324
- map and filter methods, 330
- peekable, 337
- reversible, 339
- scan adapter, 335
- skip and skip\_while adapters, 336
- take and take\_while adapters, 335
- traits, 322
- zip adapter, 342
- iter\_mut method, 324

## J

- Java, object-mutex relationship in, 486
- join function, 461
- join() method, 462
- json! macro, 509
  - fragment types, 510
  - importing and exporting, 519
  - recursion in, 513
  - scoping and hygiene, 516
  - using traits with, 514

## L

- last method, 350
- Latin-1 character set, 392
- lazy\_static crate, 426
- let declarations, 126
- Li, Peng, 4
- libgit2, 557
  - raw interface to, 566
  - safe interface to, 572
- libraries, 172
  - doc-tests, 182
  - documentation, 181
  - foreign functions from, 562
  - src/bin directory, 174
  - third-party (see crates)
- lifetime

- defined, 102
- distinct parameters for references, 111
- omitting parameters from references, 112
- parameters for generic functions, 242
- structs with, 203
- LinkedList<T> collection type
  - about, 376
  - defined, 360
- Linux
  - Rust package for, 7
  - using functions from libraries, 563
- literals, in patterns, 223
- lock (see mutex)
- logging
  - channels for, 483
  - formatting pointers for, 419
  - formatting values for, 418
- logical operators, 138
- log\_syntax!() macro, 509
- loop (for infinite loops), 130
- looping expressions, 130
- lvalues, 136

## M

- machine language, 558
- machine types, 46
  - Boolean, 51
  - characters, 52
  - floating-point types, 50
  - integer types, 47
- macOS
  - Rust package for, 7
  - using functions from libraries, 563
- macros, 499
  - avoiding syntax errors during matching, 521
  - basics, 500
  - built-in, 507
  - debugging, 508
  - expansion, 499, 501
  - fragment types, 510
  - importing and exporting, 519
  - json!, 509
  - procedural, 522
  - recursion in, 513
  - repetition, 505
  - scoping and hygiene, 516
  - unintended consequences, 503
  - using traits with, 514
- macro\_rules!, 501

- about, 501
- fragment types supported by, 512
- main(), 156
- Mandelbrot set
  - basics of calculation, 24
  - concurrent implementation, 23
  - concurrent program for, 35
  - mapping from pixels to complex numbers, 31
  - parsing pair command-line arguments, 28
  - plotting, 32
  - rendering with fork-join parallelism, 468
  - running the plotter, 40
  - writing image files, 33
- map adapter, 330
- map types
  - BTreeMap<K, V>, 378
  - HashMap<K, V>, 378
- map, defined, 378
- map.entry(key), 382
- mapping, 31
- match expressions, 22, 128
- Matsakis, Niko, 466
- max method, 346
- max\_by method, 346
- max\_by\_key method, 347
- memory
  - enums in, 215
  - raw pointers and, 546
  - strings in, 65
  - types for representing sequence of values in, 57
- memory ordering, 494
- method calls, fully qualified, 252
- methods
  - calling, 134
  - defining with impl, 198
  - fully qualified method calls, 252
  - integers and, 49
- min method, 346
- min\_by method, 346
- min\_by\_key method, 347
- Model-View-Controller (MVC), 319
- modules, 165
  - in separate files, 166
  - items, 170
  - libraries and, 172
  - paths and imports, 167
  - standard prelude, 169
- Morris worm, 1, 4
- moves, 77
  - and control flow, 84
  - and indexed content, 84
  - assigning to a variable, 82
  - closures and, 306
  - constructing new values, 83
  - Copy types as exception to, 86
  - defined, 2
  - passing values to a function, 83
  - returning values to a function, 83
- Mozilla, 2
- mpsc (multi-producer, single-consumer) communication, 478
- multiplication (mul), 257
- multithreaded programming, 1
  - (see also concurrency, concurrent programming)
  - type safety and, 5
- mut (exclusive access), 10, 488
- mut statics, 171
- mutability, interior, 205
- mutable references (&mutT), 95
  - FnMut, 314
  - IntoIterator implementation, 325
  - rules for, 117
  - shared references vs., 114
- mutable statics, 105
- mutexes
  - basics, 484
  - creating, 487
  - deadlocks and, 489
  - in Rust, 486
  - limitations, 488
  - multi-producer channels using, 490
  - mut and, 488
  - poisoned, 490

## N

- named-field structs, 193
- namespaces (see modules)
- NaN (not-a-number) values, 273
- networking, 453
- newtypes, 197
- normalization
  - forms, 428
  - strings and text, 427
  - unicode-normalization crate, 429
- not-a-number (NaN) values, 273

- nth method, 350
- null pointers, 100
- null raw pointers, 544
- null references, 56
- numbers, formatting, 415
- numeric types, 46
  - floating-point types, 50
  - integer types, 47

## O

- offset method, 526, 539, 541, 546
- operator overloading, 265
  - arithmetic/bitwise operators, 266
  - binary operators, 269
  - compound assignment operators, 270
  - equality tests, 272
  - generic traits and, 257
  - Index and IndexMut, 277
  - limitations on, 280
  - ordered comparisons, 275
  - unary operators, 268
- operator precedence, 140
- operators
  - arithmetic, 137
  - bitwise, 138
  - comparison, 138
  - logical, 138
- Option<&T>, 100
- ordered comparison operators, 275
- OsStr string type, 446
- ownership, 71
  - and iteration, 15
  - Arc, 90
  - basics, 73
  - Cow, 300
  - defined, 2
  - moves, 77
  - Rc, 90
  - shared, 90

## P

- panic, 145
  - aborting, 147
  - poisoned mutexes, 490
  - safety in unsafe code, 556
  - unwinding, 146
- panic!() macro, 145
- parameters
  - dynamic widths and precisions, 420

- receiving references as, 105
- PartialEq trait, 272
- PartialOrd trait, 275
- partition method, 353
- passing by value/by reference, 97, 326
- Path, 446
- Path method, 447
- PathBuf method, 447
- paths, 167
- patterns, 221
  - @ patterns, 230
  - about, 221
  - avoiding syntax errors during matching in macros, 521
  - for searching text, 402
  - guards, 229
  - literals in, 223
  - match expressions and, 128
  - matching multiple possibilities with |, 229
  - populating a binary tree, 232
  - reference patterns, 226
  - searching and replacing, 403
  - situations that allow, 230
  - struct patterns, 225
  - tuple patterns, 225
  - variables in, 224
  - wildcards in, 224
- peekable iterator, 337
- pipeline
  - limitations, 477
  - running, 476
- plotting
  - Mandelbrot set, 32
  - running the Mandelbrot plotter, 40
- pointer types, 55
  - boxes, 56
  - non-owning (see references)
  - raw pointers, 57
  - references, 56 (see references)
- pointers, Rust's restrictions on, 72
- polymorphism, 235
- position method, 348
- print!(), 440
- println!(), 150
- procedural macros, 522
- product method, 345
- profiler, 164
- propagating errors, 152
- Python, 4

## R

- race conditions, 489
- rand::random(), 258
- ranges
  - half-open, 136, 229
  - in patterns, 229
- raw interface, 566
- raw pointers, 57, 538
  - and unsafe code, 5
  - dereferencing safely, 540
  - GapBuffer example, 550
  - moving into/out of memory, 546
  - nullable, 544
  - panic safety in unsafe code, 556
  - pointer arithmetic, 545
  - RefWithFlag, 541
  - type sizes and alignments, 544
- raw strings, 64
- Rayon library, 466
- Rc pointer type, 90
- Read trait, 431
- read-only access, shared access as, 117
- read/write locks (RwLock), 491
- readers
  - basics, 433
  - binary data, compression, serialization, 444
  - buffered, 435
  - collecting lines, 439
  - defined, 432
  - opening files, 441
  - reading lines, 436
  - Seek trait, 441
  - various types, 442
- recursion, 513
- RefCell<T> struct, 207
- reference (ref) patterns, 226
- reference operators, 137
- reference-counted pointer type, 90
- references (pointer type), 56, 93
  - "sea of objects" and, 121
  - and iteration, 15
  - as values, 97
  - assigning, 98
  - borrowing, 306
  - borrowing to arbitrary expressions, 100
  - comparing, 99
  - constraints on borrowing local variables, 101
  - constraints on passing references as arguments, 107
  - constraints on receiving as parameters, 105
  - constraints on returning, 107
  - constraints on structs containing, 109
  - need for distinct lifetime parameters, 111
  - null pointers and, 100
  - omitting lifetime parameters from, 112
  - Rust vs. C++, 97
  - safety, 101
  - shared vs. mutable, 95, 114
  - to references, 99
  - to slices and trait objects, 101
- refutable patterns, 231
- RefWithFlag<'a, T>, 541
- regular expressions (regex), 424
  - basic use, 425
  - building regex values lazily, 426
- resource-constrained programming, xvi
- Result type, 148
  - catching errors, 148
  - dealing with errors that "can't happen", 155
  - declaring a custom error type, 157
  - handling errors in main(), 156
  - ignoring errors, 156
  - key points of design, 158
  - printing errors, 150
  - propagating errors, 152
  - type aliases, 150
  - with multiple error types, 153
- Result value, 14
- return expressions, 132
- rev adapter, 339
- reversible iterators, 339
- Rhs type parameter, 273
- Rng value, 259
- routers, callbacks and, 316
- rposition method, 348
- Rust (generally)
  - basics, 7
  - command-line arguments, 12
  - community, 191
  - concurrency, 23
  - installation, 7
  - reasons for using, 1
  - rules for well-behaved program, 535
  - simple function in, 10
  - simple web server, 17
  - type safety, 3



- unit testing in, 11
- rustc, 8, 507, 509
- rustdoc, 8
- rustup, 7
- RwLock method, 491

## S

- safe interface, 572
- safety
  - closures and, 311
  - invisibility of, 41
  - type safe language, 4
  - with references, 101
- safety rules, unsafe code as escape from, 5
- scan adapter, 335
- scoping, 516
- search
  - conventions for searching/iterating text, 401
  - patterns for searching text, 402
- Seek trait, 441
- Self keyword, 249
- semicolons, 124
- SEMVER variable, 426
- Send type, 479, 536
- serde library/crate, 248, 260, 444
- serialization, 444
- Serializer trait, 260
- Servo, 2
- sets, defined, 384
- shared access, 117
- shared mutable state, 484
  - atomics, 494
  - conditional variables (Condvar), 493
  - deadlock, 489
  - global variables, 496
  - multi-producer channels using mutex, 490
  - mut and mutex, 488
  - mutex basics, 484
  - mutex in Rust, 486
  - mutex limitations, 488
  - poisoned mutexes, 490
  - read/write locks (RwLock), 491
- shared references, 95
  - C's pointers to const values vs., 121
  - IntoIterator implementation, 325
  - mutable references vs., 114
  - rules for, 117, 121
- sized type, 285
- Sized type, 544
- size\_hint method, 344, 352
- skip adapter, 336
- skip\_while adapter, 336
- slices, 62
  - comparing, 372
  - IntoIterator implementation, 326
  - references to, 101
  - searching, 371
  - sorting, 370
- spawn function, 461, 464
- src/bin directory, 174
- stack unwinding, 146
- standard prelude, 169, 238
- statements, expressions vs., 123
- static (value), 105, 171, 496
- static keyword, 171
- static methods, 201
- static typing, 44
- string literals, 64
  - byte strings, 65
  - defined, 66
- string slice (&str), 66
- String types, 64, 397
  - accessing text as UTF-8, 409
  - adding text to, 399
  - as generic collections, 412
  - Ascii, 529
  - borrowing slice's content, 408
  - byte strings, 65
  - case conversion for, 406
  - conventions for searching/iterating text, 401
  - converting nontextual values to, 407
  - creating String values, 398
  - iterating over text, 403
  - non-Unicode strings, 68
  - parsing values from, 406
  - patterns for searching text, 402
  - producing text from UTF-8 data, 409
  - putting off allocation, 410
  - removing text from, 401
  - searching and replacing patterns/text, 403
  - simple inspection, 398
  - string literals, 64
  - strings in memory, 65
  - trimming text, 406
  - using, 68
  - UTF-8 and, 52
- strings and text, 391
  - characters (char), 394

- formatting numbers, 415
  - formatting text values, 414
  - formatting values, 413
  - in memory, 65
  - normalization, 427
  - passing between Rust and C, 560
  - regular expressions, 424
  - String and str types, 397
    - (see also String type)
  - Unicode, 392
  - Stroustrup, Bjarne, 2
  - struct expression, 194
  - struct patterns, 225
  - structs, 193
    - defining methods with impl, 198
    - deriving common traits for struct types, 204
    - generic, 202
    - hash implementation, 387
    - implementing with enums, 216
    - interior mutability, 205
    - layout, 197
    - named-field, 193
    - references in, 109
    - tuple-like, 196
    - unit-like, 197
    - with lifetime parameters, 203
  - submodules, 169
  - subtraits, 250
  - sum method, 345
  - Sync type, 479, 536
  - synchronous channel, 479
  - syntax errors, macros and, 521
  - systems programming, xv, 1
- T**
- take adapter, 335
  - take\_while adapter, 335
  - tests, 178
    - doc-tests, 182
    - integration tests, 180
  - text
    - accessing as UTF-8, 409
    - adding to String, 399
      - (see also strings and text)
    - case conversion for, 406
    - conventions for searching/iterating, 401
    - GapBuffer, 550
    - iterating over, 403
    - patterns for searching, 402
      - producing from UTF-8 data, 409
      - removing from String, 401
      - searching and replacing, 403
      - trimming, 406
  - text directionality, 394
  - text values, 414
  - threads
    - and channels, 470
    - deadlock, 489
    - thread safety with Send and Sync, 479
  - token tree, 513
  - tokens, 502
  - ToOwned trait, 300
  - trace\_macros!(), 509
  - trait objects, 238
    - about, 238
    - defined, 239
    - generic code vs., 243
    - layout, 239
    - references to, 101
    - unsized types and, 285
  - traits
    - and other people's types, 247
    - buddy, 258
    - default methods for defining/implementing, 246
    - defined, 13, 235
    - defining and implementing, 245
    - for defining relationships between types, 253
    - for operator overloading, 265
    - for struct types, 204
    - fully qualified method calls and, 252
    - generic, 257
    - Iterator/IntoIterator, 322
    - iterators and associated types, 254
    - reverse-engineering bounds, 260
    - Self as type, 249
    - static methods and, 251
    - subtraits, 250
    - unsafe, 536
    - using, 237
    - utility (see utility traits)
    - with macros, 514
    - Zeroable, 536
  - Travis CI, 191
  - trees, 76
  - trimming, 406
  - tuple patterns, 225

- tuple-like structs, 196
- tuples, 54, 135
- type aliases, 150, 170
- type alignment, raw pointers and, 544
- type inference, 44
- type parameters, 29, 202, 240
- type safety, 3
- type size, raw pointers and, 544
- type-safe language, 4
- types, 43
  - and operator overloading, 265
  - arrays, 58
  - casts and, 139
  - closures and, 308
  - Copy types, 86
  - for representing sequence of values in memory, 57
  - goals of, 43
  - IntoIterator implementations, 325
  - iterators and associated types, 254
  - machine, 46
  - pointer types, 55
  - Result type, 148
  - separating methods from definition, 201
  - sized type, 285
  - slices, 62
  - traits for adding methods to, 247
  - traits for defining relationships between, 253
  - tuples, 54
  - user-defined, 170
  - vectors, 59

## U

- unary operators, 268
- undefined behavior, 3, 527, 533
- Unicode, 392
  - ASCII and, 392
  - character literals, 52
  - Latin-1 and, 392
  - normalized forms, 428
  - OsStr and, 446
  - text directionality, 394
  - unicode-normalization crate, 429
  - UTF-8, 392
- unicode-normalization crate, 429
- unit testing, 11
- unit-like structs, 197
- Unix

- backpressure, 479
- pipes, 470
- symlink function, 451
- unsafe blocks, 527
  - Ascii string type conversion, 529
  - dereferencing raw pointers with, 57
  - unsafe functions vs., 533
- unsafe code, 5, 525
  - foreign functions, 557 (see foreign functions)
  - incorrect use of, 526
  - panic safety in, 556
  - raw pointers, 538
    - (see also raw pointers)
  - undefined behavior, 533
  - unsafe blocks, 527
  - unsafe blocks vs. unsafe functions, 533
  - unsafe functions, 531
  - unsafe traits, 536
- unsafe functions, 531
- unsafe traits, 536
- unsized types, 285
- unwinding, 146
- user-defined types, 170
- usize type, 47
- UTF-8, 392
  - accessing text as, 409
  - char type and, 52
  - OsStr and, 446
  - producing text from data, 409
  - strings in memory, 65
- utility traits, 281
  - AsRef and AsMut, 294
  - Borrow and BorrowMut, 296
  - Clone, 287
  - Copy, 289
  - Cow, 300
  - Default, 292
  - Deref and DerefMut, 289
  - drop, 282
  - From and Into, 297
  - sized, 285
  - ToOwned, 300

## V

- values
  - parsing from strings, 406
  - passing by value/by reference, 97
  - receiving via channels, 475

- references as, 97
- sending via channels, 472
- variable capture, 305
- variables
  - assigning to, 82
  - declaring, with foreign functions, 561
  - global, 496
  - in patterns, 224
  - ownership (see ownership)
- vec! macro, 505
- Vec<T> collection type, 57, 60, 361
  - accessing elements, 362
  - comparing slices, 372
  - defined, 360
  - growing/shrinking vectors, 364
  - invalidation errors, 373
  - iteration, 364
  - joining, 367
  - random elements, 373
  - searching, 371
  - sorting, 370
  - splitting, 368
  - swapping, 370
- VecDeque<T> collection type
  - about, 374
  - defined, 360
  - LinkedList<T> vs., 377
- vectors, 59
  - basics, 59
  - building element by element, 62
  - slices and, 62

- versions, 186
- vertical bar (|), 229
- virtual table (vtable), 239

## W

- weak pointers, 92
- web server, creating with Rust, 17
- well-behaved program, 535
- well-defined program, 4
- while let loop, 130
- while loop, 130
- wildcards, 186, 224
- Windows
  - Rust package for, 7
  - using functions from libraries, 563
- work-stealing, 468
- workspaces, 190
- Write trait, 431, 440
- writers, 439
  - defined, 432
  - Seek trait, 441
  - various types, 442

## X

- x @ pattern, 230

## Z

- zero-overhead principle, 2
- Zeroable trait, 536
- zip adapter, 342

## About the Authors

---

**Jim Blandy** has been programming since 1981, and writing free software since 1990. He has been the maintainer of GNU Emacs and GNU Guile, and a maintainer of GDB, the GNU Debugger. He is one of the original designers of the Subversion version control system. Jim now works on Firefox's web developer tools for Mozilla.

**Jason Orendorff** hacks C++ for Mozilla, where he is module owner of the JavaScript engine that's in Firefox. He is an active member of the Nashville developer community and an occasional organizer of homegrown tech events. He is interested in grammar, baking, time travel, and helping people learn about complicated topics.

## Colophon

---

The animal on the cover of *Programming Rust* is a Montagu's crab (*Xantho hydrophilus*).

This robust-looking crab has a muscly appearance with a broad carapace about 70 mm wide. The edge of the carapace is furrowed and the color is yellowish or reddish-brown. It has 10 legs (five pairs): the front pair of legs (the chelipeds) are equal in size with black-tipped claws or pincers; then there are three pairs of walking legs that are stout and relatively short; and the last pair of legs are for swimming. They walk and swim sideways.

Montagu's crab has been found in the northeastern Atlantic ocean and in the Mediterranean Sea. It lives under rocks and boulders during low tide. If one is exposed when a rock has been lifted, it will aggressively hold its pincers up and spread them wide open to make itself appear bigger.

This crab eats algae, snails, and crabs of other species. It is mostly active at night. Egg-bearing females are found from March through July and the larvae are present on plankton for most of the summer.

Many of the animals on O'Reilly covers are endangered; all of them are important to the world. To learn more about how you can help, go to [animals.oreilly.com](http://animals.oreilly.com).

The cover image is from *Wood's Natural History*. The cover fonts are URW Type-writer and Guardian Sans. The text font is Adobe Minion Pro; the heading font is Adobe Myriad Condensed; and the code font is Dalton Maag's Ubuntu Mono.